

# **SRHQ** STREET ROD *HEADQUARTERS*

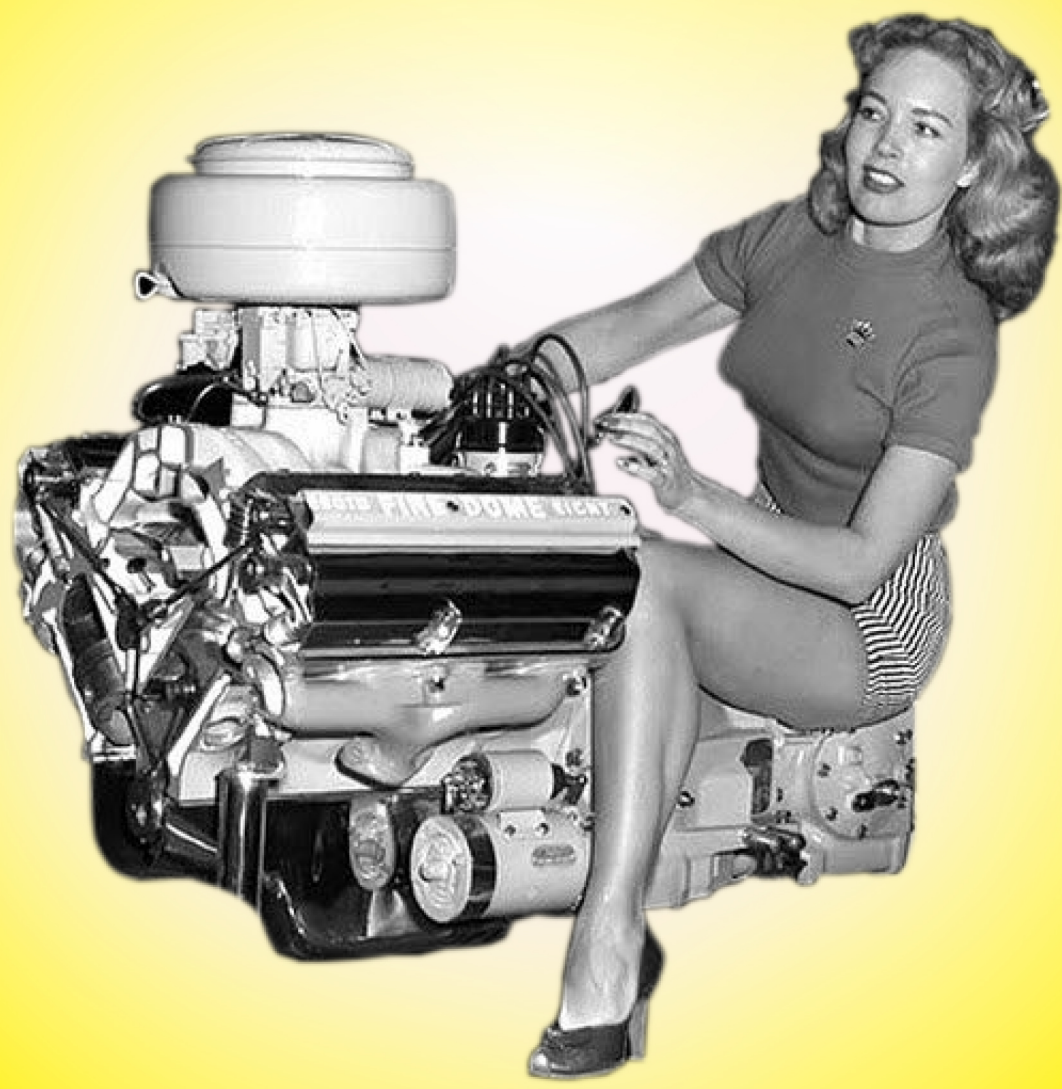

**800-952-1752**  
**[www.streetrodhq.com](http://www.streetrodhq.com)**

To our Valued Customers:

*This catalog features our expanding inventory of street rod parts for a variety of vehicles including Chevy, Chrysler and Ford in a wide range of years. For over 32 years we have been providing the best in restoration parts for 1937–1954 Chevrolet cars and trucks and an ever-increasing selection of Street Rod Parts. We strive to provide the best in service, quality and variety of parts needed for your vehicle.*

*Chevy parts are found in our Chevs of the 40's catalogs for cars and trucks. These parts are also found online at [www.chevsofthe40s.com](http://www.chevsofthe40s.com) and [www.streetrodhq.com](http://www.streetrodhq.com). Thanks for your business!*

Ron Wade  
CEO/Owner

## HOW TO ORDER

**ONLINE:** Order anytime by accessing our online catalog from our website, [www.chevsofthe40s.com](http://www.chevsofthe40s.com). Credit card information is secure and we don't sell our customer database to anyone.

**Call toll-free:** 1-800-952-1752

Our sales reps are available to assist you:

- via the phone: Monday–Friday, 6 a.m. – 5 p.m. Pacific Time
- in the showroom: Monday–Friday, 8 a.m. – 5 p.m.
- via our lovable voice mail for after-hour and weekend calls.

Existing customers—Simply provide your name and customer number off your catalog label, vehicle year, series and body style, credit card number (if appropriate), part numbers with descriptions and quantities.

New customers—Please provide all of the above information as well as your phone number (in case we have a question about the order) and a complete address including zip code.

**Fax** (order form in the back of the catalog):

- 1-800-888-2438
- Local/International: 1-360-816-0215

## HOW TO PAY

Use **Check by Phone** to achieve prompt shipping (10 days faster than mailing a check.) And because it helps reduce our costs, our reward to you is a 4% discount on parts when you place your first electronic-check order by phone. Try it—it's convenient and secure.

**Checks** by mail are welcome; however the accounting department may hold your order on uncertified funds. At company discretion, a mailed-in check may be converted to an electronic check.

Checks and money orders need to be in U.S. funds.

Returned checks will be charged an NSF fee.

**Credit Cards**—Visa, MasterCard and Discover are welcome! **Ship-to address must match your credit card billing address.**

## HOW WE SHIP

We ship via UPS and USPS Flat Rate Priority Mail (size and weight permitting). For international orders we use UPS expedited or USPS Priority Mail. Please talk to our sales staff for a shipping quote.

**Rates:** Our software computes the UPS shipping and handling charges using the best method. Minimum shipping fee is approximately \$14.

When purchasing oversized parts, some can be shipped via UPS and others need to be sent via truck freight, so please call for rates.

If paying by check, please call for shipping rates and order total.

**Shipping Time** on ground deliveries takes 2 to 14 days depending on your location. For faster service options, when placing an order, please ask your sales person for an express delivery quote.

*Most orders ship the same day!*

**Sales Tax:** Due to the Wayfair decision, we must now charge sales tax to all applicable states. Tax is calculated on the order total (including shipping). Tax rates vary depending on your tax region.

## HOW PROBLEMS ARE HANDLED

**Damage Claims:** If a package appears to be damaged upon delivery, open the package with the delivery driver and have them note any damages. Then call Chevs of the 40s immediately to notify us of any problems/damages. Do not ship to Chevs of the 40s; we will let you know what to do next.

**Shortages:** All parts are scanned with a barcode scanner as your order is packaged making sure you get what you ordered. If, in the unlikely event a shipment error occurs, call us immediately.

**Back Orders:** Our computerized inventory system allows us to maintain tight control on our stocking levels. However, we do not have control over our suppliers. Back orders are not charged until they ship. Shipment occurs immediately when we receive the part.

## RETURNS/EXCHANGES

Made-to-order items, such as glass, are non-returnable. All other parts (excluding Odds & Ends) may be returned within 30 days. Damaged or altered parts cannot be returned. CODs will not be accepted. Returns subject to a 25% restocking fee.

1. Have your invoice ready.
2. Call 1-800-952-1752.
3. Obtain return authorization number.
4. Write the number on the outside of the package and on a copy of the invoice.
5. Include invoice copy in package.

Remember: Shipping can take up to 14 days, so allow 3–4 weeks on returns. Warranty applies only to purchase price of item or replacement of part.

Unfortunately credit card companies no longer credit your credit cards for returns after 90 days. Therefore, we will issue in-store credits or a refund check.

*Note: Product pricing and availability subject to change.*

## PHOTOS

Email us high-resolution photos of your street rods! We love to see them and might even put them in one of our catalogs or advertisements!

**Stuff our attorneys want us to say: Chevs of the 40's will not be responsible for any expenses incurred for installation, modification, fitting or shop repairs of parts. The items sold in this catalog are without warranties of any kind. Items and prices in this catalog are subject to change without notice. Information in this catalog may contain typographical errors or inaccuracies. We reserve the right to correct errors or omissions.**



Refer to our Illustrated Index on the following pages to easily find the parts you are looking for. Parts are referenced by the major components and sorted per section. Refer to that component's section for associated parts. Example: Suspension section will have shocks and related parts.

Reference our Section listings and use our handy thumb tabs. You can also reference our index in the back of the catalog.

Our friendly, knowledgeable sales staff will be happy to answer any questions you may have about our parts. Feel free to visit our web site for any introductory new parts we may be offering.

All prices in this catalog are subject to change without notice. Since we are unable to control our suppliers, product availability may change without warning.

**Art, Collectibles, Tools, Car Care,  
Car & Truck Covers**  
(Sect. 10, 12, 15)

**Engine: Crate Engines, Engine  
Components, Motor Mounts**  
(Sect. 20, 22, 26)

**Cooling, Heating, Front Dress  
Components**  
(Sect. 30, 32, 35)

**Engine Electrical: Starters,  
Alternators, Distributors, Ignition**  
(Sect. 40, 45, 50)

**Electrical, Horns**  
(Sect. 60)

**Lighting: Turn Signals, Headlights,  
Tail Lights**  
(Sect. 80, 100, 110)

**Fuel & Exhaust**  
(Sect. 120, 130)

**Transmission, Driveline, Rear End**  
(Sect. 150, 170)

**Brakes**  
(Sect. 180)

**Steering**  
(Sect. 190)

**Suspension: Front, Chassis &  
Bodies, Rear**  
(Sect. 200, 205, 210)

**Wheels**  
(Sect. 220)

**Front End: Bumpers, Grilles, Hoods,  
Fenders**  
(Sect. 230, 240, 250, 270)

**Firewall, Floorboard: Insulation,  
Pedals, Sheetmetal, Running  
Boards** (Sect. 295, 310, 320)

**Interior: Seats, Doors, Consoles,  
Mirrors, Dashes, Gauges, Radio**  
(Sect. 330, 345, 350, 360)

**Wipers, Door Parts, Glass, Power  
Window Kits**  
(Sect. 370, 380, 420, 460)

**Truck Beds and Trunk**  
(Sect. 490)

**Books**  
(Sect. 560)

**Parts Index**

**A**

ADHESIVES & SEALERS ..... 20  
 AIR BAGS ..... [164-165](#)  
 AIR CLEANERS ..... [115, 118-121](#)  
 AIR CONDITIONING ..... [59-64](#)  
 AIR FILTERS ..... [101, 120](#)  
 AIR SCOOPS ..... [119](#)  
 ALTERNATORS ..... [67-71](#)  
 ALUMINUM BUNDLE STRAP ..... [65, 80](#)  
 ANTENNAS ..... [241](#)  
 ARM RESTS ..... [216](#)  
 ARTWORK ..... [9-10](#)  
 ASH TRAYS ..... [238](#)  
 AUTO LITERATURE ..... [77, 275](#)

**B**

BACK GLASS ..... [258](#)  
 BATTERY & RELATED ..... [19, 66-67](#)  
 BEAUTY RINGS ..... [168](#)  
 BED FLOOR ..... [268-271](#)  
 BED LIDS ..... [268](#)  
 BED ROLL LIGHTS ..... [96, 271](#)  
 BLUETOOTH SPEAKERS ..... [241](#)  
 BRAKE CLEANER ..... [21](#)  
 BRAKE FLUID ..... [21](#)  
 BRAKE LIGHTS ..... [89, 95-96, 99](#)  
 BRAKE LINES ..... [141](#)  
 BRAKE PEDALS ..... [212-213](#)  
 BRAKES & RELATED ..... [138-139](#)  
 BULBS-HALOGEN ..... [88-89](#)  
 BULBS-LED ..... [82, 100](#)  
 BULK TUBING ..... [19](#)  
 BULLNOSE ..... [190](#)  
 BUMPERS ..... [170-172](#)

**C**

C5 ..... [154](#)  
 CARBURETOR CLEANER ..... [21](#)  
 CARBURETORS ..... [114](#)  
 CAR CARE ..... [13-17, 21](#)  
 CAR COVERS ..... [17](#)  
 CLIPS-MAGNETIC ..... [79-80, 121, 201, 215-216](#)  
 COIL RELOCATION KIT ..... [74](#)  
 COLLECTIBLES ..... [7-8](#)  
 CONTINENTAL KITS ..... [170](#)  
 COOLERS ..... [8-9](#)  
 CORE SUPPORT ..... [200](#)  
 COWL VENTS ..... [242](#)  
 CRANKSHAFT ..... [57-59](#)  
 CRATE ENGINES ..... [23-25](#)  
 CROSSMEMBER ..... [158](#)  
 CROSSMEMBERS ..... [40, 157-159](#)  
 CRUISE CONTROL ..... [153](#)  
 CUP HOLDERS ..... [216, 238](#)  
 CURB FEELERS ..... [193](#)

**D**

DASH & RELATED ..... [235-239](#)  
 DIMMER SWITCH ..... [89, 213](#)  
 DISC BRAKES ..... [136-137](#)  
 DISTRIBUTORS ..... [72](#)  
 DOME LIGHTS ..... [217](#)  
 DOOR ..... [215-216, 250-256, 258, 263](#)  
 DOOR CONTACTS ..... [252, 263](#)  
 DOOR GLASS & RELATED ..... [258](#)  
 DOOR HANDLES ..... [250, 252-255](#)  
 DOOR HINGES ..... [250](#)  
 DOOR LATCHES ..... [250-252](#)  
 DOOR LOCKS ..... [251-252](#)  
 DOOR PANELS ..... [215](#)  
 DOOR POPPERS ..... [250](#)  
 DOOR PROPS ..... [251](#)  
 DOOR PULLS ..... [216, 255-256](#)  
 DOOR WEATHERSTRIP ..... [256](#)

**E**

EMERGENCY BRAKES ..... [139-141](#)  
 ENGINE BLOCKS ..... [17-18](#)  
 ENGINE COMPONENTS ..... [38-39](#)  
 ENGINE DIPSTICKS ..... [38-39](#)  
 ENGINE DRESS UP KITS ..... [25-26](#)  
 ENGINE MOUNT KITS ..... [40-41](#)  
 EXHAUST & RELATED ..... [113-114, 122-125](#)

**F**

FAN ..... [64](#)  
 FANS ..... [45-46](#)  
 FENDER COVERS ..... [19](#)  
 FENDERS ..... [191-194](#)  
 FIREWALL & RELATED ..... [198-199, 202-205](#)  
 FLOORBOARDS ..... [199, 210](#)  
 FLYWHEEL DUST COVERS ..... [128](#)  
 FRAME ADAPTERS ..... [41](#)  
 FRONT CROSSMEMBERS ..... [158](#)  
 FRONT SUSPENSION ..... [154-160](#)  
 FUEL DOORS ..... [108-109](#)  
 FUEL LINES ..... [115, 121](#)  
 FUEL LOGS ..... [114](#)  
 FUEL PICKUP UNIT ..... [108](#)  
 FUEL PUMPS ..... [107-108, 116-117](#)  
 FUEL RAILS ..... [115](#)  
 FUEL REGULATORS ..... [108](#)  
 FUEL SENDING UNITS ..... [106-107](#)  
 FUEL STABILIZERS ..... [20](#)  
 FUEL SYSTEM ..... [105-106, 108, 110, 115-116, 271](#)

**G**

GAS CAPS ..... [109-110, 271-272](#)  
 GAS FILLER ..... [110](#)  
 GAS PEDALS ..... [211-212](#)  
 GAS TANK RESTORATION KIT ..... [20](#)  
 GAS TANKS ..... [101-106](#)  
 GAS TANK SEALER SLOSH ..... [20](#)

GAS TANK STRAPS . . . . . [105](#)  
 GEAR POSITION INDICATORS . . . . . [133](#)  
 GEAR SHIFT ARMS . . . . . [147](#)  
 GIFT CERTIFICATES . . . . . [5](#)  
 GIFTS . . . . . [7](#)  
 GLASS . . . . . [258-259](#)  
 GLOVE BOXES . . . . . [238](#)  
 GRILLES . . . . . [175-178](#)

**H**

HATS . . . . . [8](#)  
 HEADER PANEL . . . . . [242](#)  
 HEADLIGHTS . . . . . [84-88, 239](#)  
 HEADLINERS . . . . . [214-215](#)  
 HEATER & RELATED . . . . . [61-64](#)  
 HOG RINGS . . . . . [217](#)  
 HOOD PROPS . . . . . [274](#)  
 HOOD & RELATED . . . . . [179-190, 272-273](#)  
 HORNS & RELATED . . . . . [79, 150-152](#)  
 HOSE CLAMPS . . . . . [48, 64-65, 116](#)  
 HOSE REDUCERS . . . . . [48](#)  
 HOSE SEPARATORS . . . . . [48-49, 65, 116](#)  
 HUB CAPS . . . . . [166-168](#)

**I**

IGNITION & RELATED . . . . . [73-74, 76, 238](#)  
 INNER FENDER . . . . . [200](#)  
 INSTRUMENT GAUGES & RELATED . . . . . [160, 222-235](#)  
 INSULATION . . . . . [22, 206-210, 215](#)  
 INTAKE MANIFOLDS . . . . . [110-113, 115](#)  
 INTAKE SYSTEMS . . . . . [110](#)  
 INTERIOR LIGHTS . . . . . [218, 255](#)

**K**

KICKDOWN KITS . . . . . [129](#)  
 KICK PANEL . . . . . [215](#)

**L**

LED BOLTS . . . . . [82](#)  
 LENS PANELS . . . . . [89-90](#)  
 LICENSE . . . . . [173-175](#)  
 LICENSE PLATES & RELATED . . . . . [173-175](#)  
 LINEAR ACTUATORS . . . . . [190, 274-275](#)  
 LINE CLAMPS . . . . . [121-122, 130, 141](#)

**M**

MASTER CYLINDERS . . . . . [137-139](#)  
 METAL PREP . . . . . [20, 106](#)  
 MIRRORS . . . . . [218-222](#)  
 MOTOR MOUNTS . . . . . [41](#)

**N**

NEON SIGNS . . . . . [10-11](#)  
 NOVELTIES . . . . . [7](#)

**O**

OIL & COMPONENTS . . . . . [35-37](#)  
 OVERFLOW TANKS . . . . . [44-45](#)

**P**

PAINTS . . . . . [14, 21-22](#)  
 PARKING BRAKE . . . . . [139](#)  
 PARK LIGHTS . . . . . [81](#)  
 PEDAL MOUNT -CHEVY . . . . . [136](#)  
 PITMAN ARM . . . . . [146](#)  
 POWER STEERING . . . . . [56-57, 142, 144, 146](#)  
 POWER WINDOWS . . . . . [259-263](#)  
 PULLEYS . . . . . [51-56](#)  
 PULSE GENERATORS . . . . . [129, 235](#)

**Q**

QUARTER WINDOWS . . . . . [258-259](#)

**R**

RADAR LASER JAMMER . . . . . [241](#)  
 RADIATORS . . . . . [42-45, 48](#)  
 RADIOS . . . . . [239-241](#)  
 REAR AXLE . . . . . [163-164](#)  
 REAR DIFFERENTIAL . . . . . [134-135](#)  
 REAR SUSPENSION . . . . . [163-165](#)  
 RING & PINION . . . . . [134](#)  
 ROLL PANS . . . . . [172-173](#)  
 RUNNING BOARDS . . . . . [200-201](#)  
 RUST TREATMENT . . . . . [20-21](#)

**S**

SCRIPT EMBLEMS . . . . . [5](#)  
 SEAT COMPONENTS . . . . . [216-217](#)  
 SERPENTINE PULLEY SYSTEMS . . . . . [52](#)  
 SHEET METAL . . . . . [195-200](#)  
 SHIFTERS & RELATED . . . . . [130-133](#)  
 SHIFT INDICATORS . . . . . [146](#)  
 SOUND DEADENING . . . . . [206-210](#)  
 SPARK PLUG WIRES . . . . . [74](#)  
 SPEEDOMETERS . . . . . [129, 235](#)  
 SPINDLE NUT . . . . . [160](#)  
 STARTERS & RELATED . . . . . [66](#)  
 STEERING COLUMNS & RELATED . . . . . [142-144, 146-148](#)  
 STEERING WHEELS . . . . . [149-152](#)  
 STOOLS . . . . . [13](#)  
 SUNVISORS . . . . . [214](#)  
 SWAY BARS . . . . . [157, 160, 165](#)

**T**

TAILGATES . . . . . [267-268](#)  
 TAIL LIGHTS . . . . . [81, 90-100, 271](#)  
 THERMOSTATS . . . . . [46-48](#)  
 THIRD BRAKE LIGHTS . . . . . [99](#)

NOTE: Any chemicals will be shipped domestic ground only (Lower 48 states only). No international shipping.

THROTTLE CABLES & RELATED .....	<a href="#">117-118</a>
TIMING GEARS .....	<a href="#">39</a>
TIMING TABS .....	<a href="#">39</a>
TIRES .....	<a href="#">168</a>
TOE BOARD .....	<a href="#">199</a>
TOOLS .....	<a href="#">19, 21</a>
TRAFFIC LIGHT VIEWERS .....	<a href="#">214</a>
TRANSMISSION .....	<a href="#">201</a>
TRANSMISSIONS & COMPONENTS .....	<a href="#">89, 126-130, 201</a>
TRUCK BEDS .....	<a href="#">96, 267, 271</a>
TRUCK COVERS .....	<a href="#">17</a>
TRUNK FLOOR .....	<a href="#">199</a>
TRUNK & RELATED .....	<a href="#">272-275</a>
T-SHIRTS .....	<a href="#">7-8</a>
TURN SIGNALS .....	<a href="#">81-84, 94</a>

**U**

U-JOINTS .....	<a href="#">148-149</a>
----------------	-------------------------

**V**

VACUUM ADVANCES .....	<a href="#">73</a>
VALVE COVERS .....	<a href="#">26-34</a>
VALVE STEMS .....	<a href="#">169</a>
VEHICLE ACCESSORIES .....	<a href="#">5-7</a>
VENT WINDOW & RELATED .....	<a href="#">258-259, 263-264</a>
VOLTAGE BOOSTERS .....	<a href="#">79, 242</a>
VOLTAGE REDUCERS .....	<a href="#">78-79, 239</a>

**W**

WALL CLOCKS .....	<a href="#">11-13</a>
WALL SIGNS .....	<a href="#">13</a>
WATER PUMPS .....	<a href="#">49-51</a>
WHEELS .....	<a href="#">149-152, 166, 168</a>
WINDOW CRANKS .....	<a href="#">263-265</a>
WINDSHIELDS .....	<a href="#">256-258</a>
WINDSHIELD WIPERS .....	<a href="#">242-249</a>
WIRE CLAMPS .....	<a href="#">80</a>
WIRE HARNESSSES .....	<a href="#">77-78</a>
WIRE LOOMS .....	<a href="#">74-76, 252</a>
WIRE PORTS .....	<a href="#">79</a>
WIRE SEPARATORS .....	<a href="#">74-75</a>
WIRE SOCKETS .....	<a href="#">80</a>



Reference our illustrated index pages or our text index pages in the back of catalog to easily find your Street Rod parts.

LED Tail Light Conversion Kits & Flush Mount Tail Light Kits  
Section 110

NOTE: Any chemicals will be shipped domestic ground only (Lower 48 states only). No international shipping.

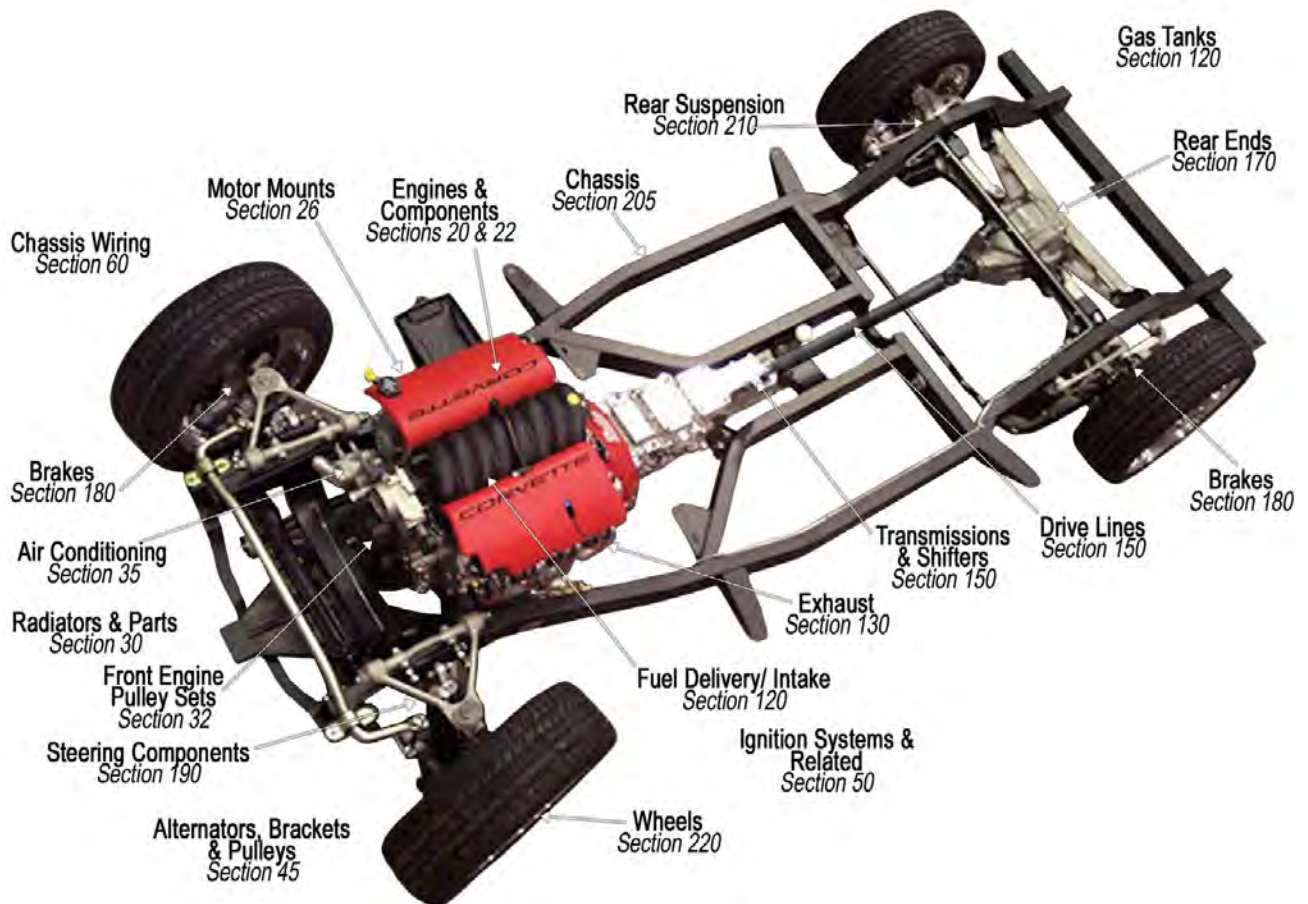

Returns require a return authorization number—Please call first. • Note: Product pricing and availability subject to change.





# You Really Considered Buying Somewhere Else?!

**Our Everyday Price Often Trounces Competitors' Sale Prices.**

**Price Match On Competitors' Like Items.**

**Incredible Return Policy—Even If Purchased Somewhere Else.**

**Almost 1 Million Parts On Our Shelves.**

**CUTTING EDGE TECHNOLOGY—  
Ensures You Get The Parts You Ordered.**

**CUTTING EDGE TECHNOLOGY—  
Provides Same-Day Shipping On Orders Placed By 1 PM PT.**

**CUTTING EDGE TECHNOLOGY—  
Easy-To-Use Mobile-Friendly Website.**

**CUTTING EDGE TECHNOLOGY—  
New Phone System Reduces Hold Time By Calling You Back  
Without Losing Your Place In Line.**

**Our Friendly Sales Staff's Expertise Is Second To None.**

**Gift Certificates**



- GIFTCERT0025 .....ALL
- \$25 Gift Certificate -0 .. \$25.00 EA
- ⚠
- GIFTCERT0050 ..... ALL
- \$50 Gift Certificate -0 .. \$50.00 EA
- ⚠
- GIFTCERT0075 ..... ALL
- \$75 Gift Certificate -0 .. \$75.00 EA
- ⚠
- GIFTCERT0100 ..... ALL
- \$100 Gift Certificate -0 \$100.00 EA
- ⚠
- GIFTCERT0150 ..... ALL
- \$150 Gift Certificate -0 \$150.00 EA
- ⚠
- GIFTCERT0200 ..... ALL
- \$200 Gift Certificate -0 \$200.00 EA
- ⚠
- GIFTCERT0500 ..... ALL
- \$500 Gift Certificate -0 \$500.00 EA
- ⚠
- GIFTCERT1000 ..... ALL
- \$1000 Gift Certificate -0 .. \$1,000.00 EA ⚠
- GIFTCERT5000 ..... ALL
- \$5000 Gift Certificate -0 .. \$5,000.00 EA ⚠

**Fender And Trunk Script Emblems**

*Supercharged*

R6272.....ALL

"Supercharged" Emblem -0.15 .. \$10.39 EA ⚠

*Streetrod*

R6273.....ALL

"Streetrod" Emblem -0.2 .. \$11.00 EA ⚠

*Hotrod*

R6274.....ALL

"Hotrod" Emblem -0.2 ... \$9.75 EA ⚠

**Fender And Trunk Script Emblems, cont.**

*Blown*

R6276.....ALL

"Blown" Emblem -0.15 .. \$10.19 EA ⚠

*Cruisin*

R6277.....ALL

"Cruisin" Emblem -0.2 \$11.25 EA ⚠

*Turbocharged*

R6278.....ALL

"Turbocharged" Emblem -0.15 .. \$10.00 EA ⚠

**Vehicle Accessories**

10887.....ALL

Chrome bullet wing nut license fastener. Set of 4 -0.15 .. \$5.00 SET ⚠

8BALL70204.....ALL

Fuzzy 8 Ball Black -0.15 \$5.75 EA ⚠

985094.....ALL

Glass jewel reflector. Specify Red, Green, Blue, Amber, Burnt Orange, Purple, Clear, Light Blue, Yellow, Rainbow. (2 pcs). 9.777 -0.2 .....starting at \$20.00 PR ⚠

**Vehicle Accessories, cont.**

BIS77002.....ALL

Bowtie hitch cover. -0.15 .. \$32.00 EA ⚠

DICE.....ALL

Classic Fuzzy Dice, Chose Black, Blue or Red -0.15 ..... \$5.00 PR ⚠

DLK70023.....ALL

8 Ball Door Lock Knob -0.15 ..... \$6.00 PR ⚠

DLK70044.....ALL

Chrome Metal Tube Door Lock Knob -0.15 ..... \$4.50 PR ⚠

DLK70095.....ALL

Iron Cross Door Lock Knob -0.15 ..... \$6.50 PR ⚠

FELIX.....ALL

Universal Felix the cat license frame ornament. -0.15 ..... \$20.00 EA ⚠

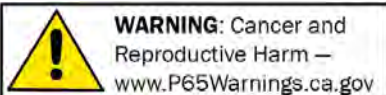

NOTE: Any chemicals will be shipped domestic ground only (Lower 48 states only). No international shipping.

**Vehicle Accessories, cont.**



**FLAG01** .....ALL  
License Plate Frame  
Accessory, U.S.A.  
Flag -0.4  
..... **\$2.75 EA** ⚠



**FLAG02** .....ALL  
Flag Holder - 5  
Post -0.15  
..... **\$6.75 EA** ⚠



**FLAG03** .....ALL  
Flag Holder-Chrome  
3 Post -0  
..... **CALL** ⚠



**LF70045**.....ALL  
8 Ball License Plate Fastener -0.15  
..... **\$4.39 PR** ⚠



**LF70065**.....ALL  
Lion Head License Plate Fastener -0.15  
..... **\$4.25 PR** ⚠



**LF70070**.....ALL  
Chrome Dice License Plate Fastener -0.15  
..... **\$4.00 PR** ⚠

**Vehicle Accessories, cont.**



**LF70071**.....ALL  
Chrome Bullet License Plate Fastener -0.15  
..... **\$6.00 PR** ⚠



**LF70072**.....ALL  
Dice License Plate Fastener Green With  
White Dots -0.15  
..... **\$3.99 PR** ⚠



**LF70073**.....ALL  
Dice License Plate Fastener Purple With  
White Dots -0.15  
..... **\$4.50 PR** ⚠



**LF70074**.....ALL  
Large 8 Ball License Plate Fastener -0.15  
..... **\$5.89 PR** ⚠



**LF70096**.....ALL  
Iron Cross License Plate Fastener -0.15  
..... **\$5.75 PR** ⚠



**LF70315**.....ALL  
Chrome Skull License Plate Fastener -0.15  
..... **\$4.00 PR** ⚠

**Vehicle Accessories, cont.**



**VC69978** .....ALL  
Chrome Large 8 Ball Valve Cap -0.15  
..... **\$6.75 SET** ⚠



**VC69981** .....ALL  
Chrome Dice Valve Caps -0.2  
..... **\$4.99 SET** ⚠



**VC70004** .....ALL  
Skull Valve Caps -0.15  
..... **\$6.00 SET** ⚠



**VC70005** .....ALL  
Dice Valve Caps-Red With White Dots -0.15  
..... **\$4.00 SET** ⚠



**VC70006** .....ALL  
Dice Valve Caps-White With Black  
Dots -0.15  
..... **\$4.00 SET** ⚠



**VC70007** .....ALL  
Dice Valve Caps-Black With White  
Dots -0.15  
..... **\$4.00 SET** ⚠

**Vehicle Accessories, cont.**



**VC70008** .....ALL  
Dice Valve Caps- Blue With White  
Dots -0.15 ..... **\$4.00 SET** ⚠



**VC70022** .....ALL  
8 Ball Valve Caps -0.15 ..... **\$4.00 SET** ⚠



**VC70038** .....ALL  
Chrome Spike Valve Caps -0.15  
..... **\$6.50 SET** ⚠



**VC70054** .....ALL  
Dice Valve Caps- Purple With White  
Dots -0.15 ..... **\$4.00 SET** ⚠



**VINTAGE01** ....ALL  
Registration holder  
for your column w/  
springs. 5-1/4" X  
3-1/4" -0.15  
..... **\$8.75 EA** ⚠



**VINTAGE02** .....ALL  
Registration holder w/ clamps for your Sun  
Visor. Reproduction protector for your  
registration card. 5-1/4" x 3-3/8" -0.15  
..... **\$9.75 EA** ⚠

**Vehicle Accessories, cont.**



**WASITFD** .....ALL  
Bluetooth speaker fuzzy dice. Easy setup  
with built in microphone & stereo speakers  
makes hands free calling safe & easy.  
Works with your smart phone for calling,  
music, navigation & more.  
Rechargeable long play battery. USB  
charging cord included. Great in the shop  
or at cruise nights too. -0.15  
..... **\$109.00 EA** ⚠

**Dog Collar/Leash**



**BDDOGCCS** .....ALL  
Dog collar black with "Chevy" bowtie logo  
buckle and "Chevy" bowtie logo repeated  
around the collar for small size dog -0  
..... **\$10.50 EA** ⚠

**BDDOGCFM** ..... ALL  
Dog collar black with "Ford" oval logo  
buckle and "Ford" oval logo repeated  
around the collar for medium size dog -0  
..... **\$10.50 EA** ⚠

**BDDOGCFS** ..... ALL  
Dog collar black with "Ford" oval logo  
buckle and "Ford" oval logo repeated  
around the collar for small size dog -0  
..... **\$10.50 EA** ⚠



**BDDOGLC** .....ALL  
Dog leash with "Chevy" bowtie logo  
repeated on a 4 foot by 1" strap -0  
..... **\$9.00 EA** ⚠



**BDDOGLF** .....ALL  
Dog leash With "Ford" oval logo repeated  
on a 4 foot by 1 inch strap -0 ..... **\$8.50 EA**  
⚠

**Purse**



**BDPUSRF** .....ALL  
Black strap and silver stripe webbing with  
"Ford" emblem on the buckle -0  
..... **\$18.50 EA** ⚠

**Belt**



**BDSBBF** .....ALL  
Belt black "Ford" blue oval logo belt  
buckle. Made from black seat belt  
material. 47" long 1.5" wide. -0  
..... **\$11.50 EA** ⚠

**T-Shirts**



**SHIRT01** .....ALL  
Chevs Logo T-Shirt. Available in Red,  
White, Blue or Black.  
S,M,L,XL,XXL,XXXL -0.15 ..... **\$15.00 EA** ⚠



**SHIRT03** .....ALL  
'41 Cabriolet Art. Available in Black or Red.  
S,M,L,XL,XXL,XXXL -0.15 ..... **\$15.00 EA** ⚠



**SHIRT04** .....ALL  
'41 Cabriolet "Bustin Through". Available  
in Black or Blue. S,M,L,XL,XXL,XXXL -0.15  
..... **\$15.00 EA** ⚠



**WARNING:** Cancer and  
Reproductive Harm —  
[www.P65Warnings.ca.gov](http://www.P65Warnings.ca.gov)

NOTE: Any chemicals will be shipped domestic ground only (Lower 48 states only). No international shipping.

**T-Shirts, cont.**



**SHIRT06** .....ALL  
 Boosted 54 T-Shirt. Available in Blue or White. S,M,L,XL,XXL,XXXL -0.15 .....  
**\$15.00 EA** ⚠



**SHIRT07** .....ALL  
 47-53 Truck "Bustin Through". Available in black or blue, S,M,L,XL,XXL,XXXL -0.15 .....  
**\$15.00 EA** ⚠



**SHIRT08** .....ALL  
 T-Shirt "52 Bustin' Through". Available in black or blue, S,M,L,XL,XXL,XXXL -0.15 .....  
**\$15.00 EA** ⚠



**SHIRT09** .....ALL  
 T-Shirt "39 Bustin' Through". Available in black or blue, S,M,L,XL,XXL,XXXL -0.15 .....  
**\$15.00 EA** ⚠



**SHIRT10** .....ALL  
 T-Shirt "37 Bustin' Through". Available in black or blue, S,M,L,XL,XXL,XXXL -0.15 .....  
**\$15.00 EA** ⚠

**T-Shirts, cont.**



**SHIRT11** .....ALL  
 T-Shirt "40 Bustin' Through". Available in black or red, S,M,L,XL,XXL,XXXL -0.15 .....  
**\$15.00 EA** ⚠



**SHIRT13** .....ALL  
 Street Rod Headquarters basic Available in black , S,M,L,XL,XXL,XXXL -0 .....  
**\$15.00 EA** ⚠

**Hats**



**HAT-CHEVS1B** .....ALL  
 Black preformed ball cap with Chevs embroidered logo and red, white & blue detailing on brim. One size fits all with velcro closure. -0.15 ... **\$14.00 EA** ⚠

**HAT-CHEVS1N** .....ALL  
 Navy preformed ball cap with Chevs embroidered logo and red, white & blue detailing on brim. One size fits all with velcro closure. -0.15 ... **\$14.00 EA** ⚠



**HAT-CHEVS2** .....ALL  
 Beanie/ Stocking cap 8". Navy with Chevs embroidered logo. One size fits all. -0.15 .....  
**\$14.00 EA** ⚠

**Hats, cont.**



**HAT-CHEVS3** .....ALL  
 Beanie/ Stocking cap 12". Navy with Chevs embroidered logo. One size fits all. -0.15 .....  
**\$14.00 EA** ⚠



**HAT-CHEVS4** .....ALL  
 Beanie/ Stocking cap 12". Black with Chevs embroidered logo. One size fits all. -0.15 .....  
**\$14.00 EA** ⚠



**HAT-CHEVS5** .....ALL  
 Beanie/ Stocking cap 8". Black with Chevs embroidered logo. One size fits all. -0.15 .....  
**\$14.00 EA** ⚠

**Model 1:6 Scale Chevy Small Block**



**MODEL12SR** .....ALL  
 Produced by Liberty Classic. Cool scaled rendition of a tried-and-true classic (limited quantity). 0.000 -0.15 .....  
**\$36.50 EA** ⚠

**Vintage Coolers**



**BLACKCOOLER** .....ALL  
 Black beverage cooler. 16-1/2" x 7-1/2" x 9-3/8" internal dimensions. 0.000 -0 .....  
**\$79.00 EA** ⚠

**Vintage Coolers, cont.**



**BLUECOOLER.....ALL**  
Blue beverage cooler. 16-1/2" x 7-1/2" x 9-3/8" internal dimensions. 0.000-0  
..... \$79.00 EA ⚠



**COOLERFD.....ALL**  
Blue -Vintage "Ford" cooler Includes mini tray and side mount bottle opener. 18" x 8-3/4" x 12" deep. -0 ... \$79.00 EA ⚠



**COOLERFDBLK.....ALL**  
Black -Vintage "Ford" cooler Includes mini tray and side mount bottle opener. 18" x 8-3/4" x 12" deep. -0 ... \$79.00 EA ⚠



**REDCOOLER.....ALL**  
Red beverage cooler. 16-1/2" x 7-1/2" x 9-3/8" internal dimensions. 0.000-0  
..... \$79.00 EA ⚠

**Artwork**

Complement your office, den, garage or living room with these prints of classic Chevrolet vehicles. All are limited print runs.



**FOT054B.....54**  
Motorama display. 19.600-0.2 \$5.00 EA ⚠

**Artwork, cont.**



**ART10.....ALL**  
Rusty Row III 10" x 26". Limited print run of 650. -0.15 ..... \$65.00 EA ⚠



**ART11.....ALL**  
January Thaw 16" x 30". Limited print run of 1200. -0.15 ..... \$75.00 EA ⚠



**ART12.....ALL**  
Changing Colors 11" x 20". Limited print run of 650. -0.15 ..... \$55.00 EA ⚠



**ART13.....ALL**  
Summertime Blues 12" x 22". Limited print run of 650. -0.15 ..... \$55.00 EA ⚠



**ART14.....ALL**  
Paradise Inn 12" x 24". Limited print run of 650. -0.15 ..... \$65.00 EA ⚠



**ART16.....ALL**  
Bel Air Mansion limited to 450 prints. -0.15 ..... \$75.00 EA ⚠

**Artwork, cont.**



**ART17.....ALL**  
The Tire Swing 11" x 20" Limited to 650 prints. -0.15 ..... \$55.00 EA ⚠



**ART18.....ALL**  
Country Vettes 14" x 30" Limited to 750 prints. -0.15 ..... \$85.00 EA ⚠



**ART19.....ALL**  
Four Forties 14" x 20" Limited to 450 prints. -0.15 ..... \$65.00 EA ⚠



**ART20.....ALL**  
The Bird House 11" x 22" Limited to 650 prints. -0.15 ..... \$55.00 EA ⚠



**ART21.....ALL**  
The Tire Bath 13" x 20" Limited to 650 prints. -0.15 ..... \$55.00 EA ⚠



**ART22.....ALL**  
Rusty Row 10" x 26" Limited to 650 prints. -0.15 ..... \$65.00 EA ⚠

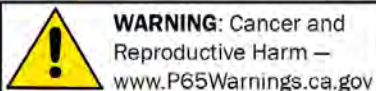

NOTE: Any chemicals will be shipped domestic ground only (Lower 48 states only). No international shipping.

**Section 010: Gift Items, Collectibles & Car Care Products**

**Artwork, cont.**



**ART23**.....ALL  
The Welding Shop 18" x 30" Limited to 750 prints -.15 ..... **\$85.00 EA** ⚠️



**ART24**.....ALL  
Cool Summer 12" x 22" Limited to 650 prints. -.15 ..... **\$55.00 EA** ⚠️



**ART25**.....ALL  
Rusty Acres 12.5" x 34". Limited to 1450 prints. -.15 ..... **\$85.00 EA** ⚠️



**ART5**.....ALL  
Ol Skool 14" x 22". Limited print run of 650. -.15 ..... **\$65.00 EA** ⚠️



**ART6**.....ALL  
Frozen Flames 12" x 24". Limited print run of 750. -.0 ..... **\$55.00 EA** ⚠️



**ART7**.....ALL  
Willys 13" x 20". Limited print run of 950. -.0 ..... **\$55.00 EA** ⚠️

**Artwork, cont.**



**ART8**.....ALL  
Roadhouse Ragtops 12" x 22". Limited print run of 650. -.15 ..... **\$65.00 EA** ⚠️



**ART9**.....ALL  
Rusty Row II 10" x 20". Limited print run of 650. -.15 ..... **\$55.00 EA** ⚠️

**Neon Marquee Sign Large 10 Foot Length**



**NEON120C0**.....ALL  
10 Feet Long! "Chevrolet Corvette Garage" in Red, Black & Yellow. -.15 ..... **\$5,000.00 EA** ⚠️



**NEON120UC**.....ALL  
10 Feet Long! OK Used Cars in Red & Yellow. -.15 ..... **\$5,000.00 EA** ⚠️

**Neon Marquee Sign & Clock 72" Length**



**NEON72GO-RED**.....ALL  
6' long x 26" tall. -.15 ..... **\$1,550.00 EA** ⚠️



**NEON72SS-BW**.....ALL  
6' long x 26" tall. -.15 ..... **\$1,550.00 EA** ⚠️

**Neon Marquee Sign & Clock 72" Length, cont.**



**NEON72SV-BLK**.....ALL  
6' long x 26" tall. -.15 ..... **\$1,550.00 EA** ⚠️



**NEON72SV-YEL**.....ALL  
6' long x 26" tall. -.15 ..... **\$1,550.00 EA** ⚠️



**NEON72UC-YEL**.....ALL  
6' long x 26" tall. -.15 ..... **\$1,550.00 EA** ⚠️

**Neon Marquee Sign 48" Length**



**NEON48G-BLK**.....ALL  
"ROUTE 66 GARAGE", 48" long x 24" tall, 8" deep. -.15 ..... **\$750.00 EA** ⚠️



**NEON48G-GRN**.....ALL  
"LAST CHANCE GARAGE", 48" long x 24" tall, 8" deep. -.15 ..... **\$750.00 EA** ⚠️

Returns require a return authorization number—Please call first. • Note: Product pricing and availability subject to change.

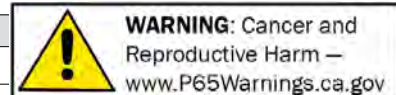

**Neon Marquee Sign 48" Length, cont.**



**NEON48G-YEL** .....ALL  
 "CHEVROLET PARTS GARAGE", 48" long x 24" tall, 8" deep. -0.15 ..... \$750.00 EA ⚠



**NEON48GL-RED** .....ALL  
 "TEXACO HIGH OCTANE GASOLINE", 48" long x 24" tall, 8" deep. -0.15 ..... \$750.00 EA ⚠



**NEON48S-BLK** .....ALL  
 "PHILLIPS 66 SERVICE", 48" long x 24" tall, 8" deep. -0.15 ..... \$750.00 EA ⚠



**NEON48S-GRN** .....ALL  
 "LAST CHANCE GARAGE SERVICE", 48" long x 24" tall, 8" deep. -0.15 ..... \$750.00 EA ⚠



**NEON48S-YEL** .....ALL  
 "CHEVROLET SERVICE", 48" long x 24" tall, 8" deep. -0.15 ..... \$750.00 EA ⚠

**Neon Marquee Sign 48" Length, cont.**



**NEON48UC-YEL** .....ALL  
 "OK USED CARS", 48" long x 24" tall, 8" deep. -0.15 ..... \$750.00 EA ⚠

**Neon Marquee Sign 34" Length**



**NEON34GS-BLK** .....ALL  
 "PHILLIPS 66 GAS", 34" long x 24" tall, 8" deep. -0.15 ..... \$700.00 EA ⚠



**NEON34GS-RED** .....ALL  
 "Mobilgas GAS", 34" long x 24" tall, 8" deep. -0.15 ..... \$700.00 EA ⚠



**NEON34GST-RED** .....ALL  
 "TEXACO GAS", 34" long x 24" tall, 8" deep. -0.15 ..... \$700.00 EA ⚠



**NEON34PG-BLK** .....ALL  
 "POLLY GAS", 34" long x 24" tall, 8" deep. -0.15 ..... \$700.00 EA ⚠

**Wall Clocks**

Neon to light up your garage, den, workshop or anywhere you can find a place for these large clocks.



**CLOCK01GMMP** .....ALL  
 Antique Sinclair Green Neon -0.15 ..... \$159.00 EA ⚠



**CLOCK01RMMP** .....ALL  
 Antique Sinclair Red Neon -0.15 ..... \$159.00 EA ⚠



**CLOCK02MMP** .....ALL  
 Chevy Garage Blue Neon -0.15 ..... \$159.25 EA ⚠



**CLOCK03MMP** .....ALL  
 Ford Motor Co Blue Neon -0.15 ..... \$159.00 EA ⚠



**CLOCK04MMP** .....ALL  
 Gear Head Blue Neon -0.15 ..... \$159.00 EA ⚠



NOTE: Any chemicals will be shipped domestic ground only (Lower 48 states only). No international shipping.



**Section 010: Gift Items, Collectibles & Car Care Products**

**Wall Clocks, cont.**



**CLOCK05MMP**.....ALL  
Genuine Chevy Parts Blue Neon -0.15  
..... \$159.00 EA ⚠



**CLOCK06MMP**.....ALL  
GMC Truck White Neon -0.15  
..... \$159.00 EA ⚠



**CLOCK07MMP**.....ALL  
GULF Blue Neon -0.15  
..... \$159.00 EA ⚠



**CLOCK08BMMP**.....ALL  
Mobile Gas Blue Neon -0.15  
..... \$159.00 EA ⚠



**CLOCK08RMMP**.....ALL  
Mobile Gas Red Neon -0.15  
..... \$159.00 EA ⚠



**CLOCK09MMP**.....ALL  
Moon Eyes Yellow Neon -0.15  
..... \$159.00 EA ⚠

**Wall Clocks, cont.**



**CLOCK10MMP**.....ALL  
Penzoil Red Neon -0.15 ... \$159.00 EA  
..... ⚠



**CLOCK11MMP**.....ALL  
Road Runner Orange Neon -0.15  
..... \$159.00 EA ⚠



**CLOCK12MMP**.....ALL  
Corvette Garage Red Neon -0.15  
..... \$159.25 EA ⚠



**CLOCK13MMP**.....ALL  
Genuine Ford Parts Blue Neon -0.15  
..... \$159.00 EA ⚠



**CLOCK14MMP**.....ALL  
Poly Gas Green Neon -0.15  
..... \$159.00 EA ⚠



**CLOCK15MMP**.....ALL  
Pontiac Service Red Neon -0.15  
..... \$159.00 EA ⚠

**Wall Clocks, cont.**



**CLOCK16MMP**.....ALL  
Sunoco Gas Yellow Neon -0.15  
..... \$159.00 EA ⚠



**CLOCK17MMP**.....ALL  
76 Gas Blue Neon -0.15 ... \$159.00 EA  
..... ⚠



**CLOCK18MMP**.....ALL  
Olds Rocket Red Neon -0.15  
..... \$159.00 EA ⚠



**CLOCK19MMP**.....ALL  
Rat Fink Green Neon -0.15  
..... \$159.00 EA ⚠



**CLOCK20MMP**.....ALL  
HURST Red Neon -0.15  
..... \$159.00 EA ⚠

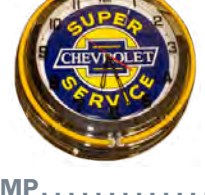

**CLOCK21MMP**.....ALL  
Super Chevy Service Yellow Neon -0.15  
..... \$159.00 EA ⚠

Returns require a return authorization number—Please call first. · Note: Product pricing and availability subject to change.



**Wall Clocks, cont.**



**CLOCK22MMP** .....ALL  
 Gilmore Gas red Neon -0.15  
 ..... \$159.00 EA ⚠



**CLOCK23BMMP** .....ALL  
 OK Used Cars Blue Neon -0.15  
 ..... \$159.00 EA ⚠



**CLOCK23RMMP** .....ALL  
 OK Used Cars Red Neon -0.15  
 ..... \$159.00 EA ⚠

**Signs**



**CHEVYGAR** .....ALL  
 Polished stainless steel, laser cut "Chevy Garage" wall sign. 32" x 13" tall. Great for any garage, office or game room. -0.15  
 ..... \$60.00 EA ⚠



**SIGN03** .....ALL  
 Chevrolet decal (as on metal sign).  
 19.450 -0.15 ..... \$12.00 EA ⚠

**Stools**

30" stools with chrome legs and 14" diameter swivel seats. Tested to hold up to 1600lbs. Many designs available, some with backrest.



**STOOLB1** .....ALL  
 Buick Service.  
 0.000 -0.15  
 ..... \$105.00 EA ⚠



**STOOLB2** .....ALL  
 Chevy Bowtie.  
 0.000 -0.15  
 ..... \$105.00 EA ⚠



**STOOLB3** .....ALL  
 Belair w/ backrest.  
 0.000 -0.15  
 ..... \$148.00 EA ⚠



**STOOLG1** .....ALL  
 GMC Trucks.  
 0.000 -0.15  
 ..... \$105.00 EA ⚠



**STOOL01** .....ALL  
 Oldsmobile Service.  
 0.000 -0.15  
 ..... \$105.00 EA ⚠



**STOOLP** .....ALL  
 Chevrolet Parts.  
 Yellow, red and blue swivel seat.  
 0.000 -0.15  
 ..... \$105.00 EA ⚠



**STOOLP1** .....ALL  
 Pontiac Service.  
 0.000 -0.15  
 ..... \$104.89 EA ⚠

**Stools, cont.**



**STOOLPB** .....ALL  
 Chevrolet Parts.  
 Yellow, red and blue swivel with backrest.  
 0.000 -0.15  
 ..... \$150.00 EA ⚠



**STOOLS** .....ALL  
 Chevrolet Service stool. Blue and white swivel seat.  
 0.000 -0.15  
 ..... \$99.00 EA ⚠



**STOOLSB** .....ALL  
 Chevrolet Service.  
 Blue and white swivel seat with backrest. 0.000 -0  
 ..... \$125.90 EA ⚠

**Car Wash & Cleaners**

**ADPDEC1GAL** ..... ALL  
 Eco Wheel Cleaner  
 Formulated for Fragile Finishes  
 DRE (Direct Release to Environment)  
 Technology  
 Powerful Cleaning  
 pH Neutral, Safe on all Surfaces.  
 1 Gallon 8.800 -0



..... CALL ⚠  
**ADPD001** ..... ALL  
 "Car Shampoo"  
 Adam's soap, specially-formulated Car Wash Soap is pH-balanced and won't strip the protective coating off your finish. This soap suds like crazy and is biodegradable. New formula can be used in a foam gun or foam cannon.  
 16 oz. bottle. 8.800 -0.15

..... \$11.00 EA ⚠  
**ADPD011** ..... ALL  
 "CARPET & UPHOLSTERY CLEANER", Adam's Non-toxic, non-allergenic cleaner. Contains no soap and will not create suds. 8.800 -0.15  
 ..... \$11.00 EA ⚠

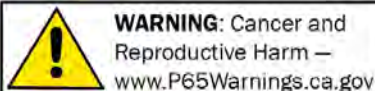

NOTE: Any chemicals will be shipped domestic ground only (Lower 48 states only). No international shipping.

**Car Wash & Cleaners, cont.**



**ADPD012 . . . . .ALL**  
 "GLASS CLEANER", Adam's Glass Cleaner out performs the competition and you will love it. 16oz. spray bottle. 8.800 -0.15

..... **\$13.00 EA** ⚠



**ADPD014 . . . . .ALL**  
 "UNDERCARRIAGE SPRAY" Adam's All Purpose Cleaner. Don't let ugly, soiled wheel wells ruin your beautiful detail job! Spray Adams All Purpose Cleaner in your fender wells

and give them a good scrubbing with a fender brush. Let the cleaner dwell while you clean the tire and wheel, then give everything a thorough rinsing. After washing, allow to air dry, blow dry or towel dry then spray a light coating of Invisible Undercarriage Spray to all areas of the fender well, then work the product in with an old towel. When you're finished, your black fender well liners will have a perfect satin black finish. Works great for engine bays too!! 16oz. spray bottle. 8.800 -0.15

..... **\$13.00 EA** ⚠



**ADPD015 . . . . .ALL**  
 "ALL-PURPOSE CLEANER", Adam's heavy duty w/ lemon scent. Tough on dirt but easy on your car. Cleans wheels, tires, engines, and more. Safely cleans your foam buffing

& polishing pads. 16oz. Spray bottle. 8.800 -0.15

..... **\$10.99 EA** ⚠



**ADPDWC16 . . . . .ALL**  
 "DEEP WHEEL CLEANER" the ultimate way to remove stubborn brake dust and metallic contamination from your wheels. Adam's 36oz. spray.

8.800 -0.15

..... **\$17.00 EA** ⚠

**Car Wash & Cleaners, cont.**



**ADPDWC1GAL . . . . .ALL**  
 "DEEP WHEEL CLEANER" the ultimate way to remove stubborn brake dust and metallic contamination from your wheels. Adam's 1 Gallon 8.800 -0.15

..... **\$70.00 EA** ⚠



**ADPG001 . . . . .ALL**  
 "CAR Shampoo" Adam's soap, specially-formulated Car Wash Soap is pH-balanced and won't strip the protective coating off your finish. This soap

suds like crazy and is biodegradable. New formula can be used in a foam gun or foam cannon. 1 gallon. 8.800 -0.15

..... **\$39.99 EA** ⚠



**ADPK002 . . . . .ALL**

"ESSENTIALS KIT". Adam's Packaged in a clear, 4-1/4 gallon detail bucket with a spin-off, sealable lid which doubles as a stool for detailing. This Kit Includes: Signature high-suds -P-H-neutral car wash soap, Clay bar, Detail spray, V.R.T., Revive Polish, Scratch & swirl remover, Butter wax, 2- Microfiber towels, Applicator pads, Detail sponges & 1-Plush wash pad. Save money with this kit over buying individual items, While supplies last.

8.800 -0.15 ..... **\$199.99 SET** ⚠



**ADPTID16 . . . . .ALL**  
 "TOTAL INTERIOR DETAILER SPRAY" is your one step solution for a clean, dressed, and factory looking interior. Adam's 16 oz. bottle. 8.800 -0.15

..... **\$11.89 EA** ⚠

**Car Wash & Cleaners, cont.**



**ADPTID1GAL . . . . .ALL**  
 "TOTAL INTERIOR DETAILER" is your one step solution for a clean, dressed, and factory looking interior. Adam's 1 Gallon. 8.800 -0.15

..... **\$40.00 EA** ⚠

**Paint Sealant Kit**



**ADPD001PS . . . . .ALL**

A blend of specially engineered acrylic polymers and bonding agents make Adam's Liquid Paint Sealant an ultra durable surface coating for your car's finish. The heat and detergent resistant formula bonds with your paint's surface to form a barrier of lasting protection against the elements as well as producing a bright, reflective shine that's ideal for your daily driver, show car, or weekend toy. Kit includes a microfiber polishing towel and two microfiber sponge applicator pads. -0.15

..... **\$45.00 EA** ⚠

**Wax & Polish**



**ADPAPW69 . . . . .ALL**  
 "AMERICANA PREMIUM CARNAUBA CAR WAX" Adam's 6.9 oz tub with applicator pad. 8.800 -0.15

..... **\$70.09 EA** ⚠



**ADPD004 . . . . .ALL**  
 "REVIVE HAND POLISH", removes moderate oxidation, swirl marks, and fading, Adam's 16 ounces. 8.800 -0.15

..... **\$19.99 EA** ⚠

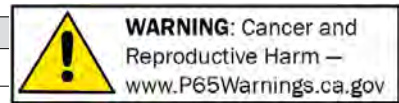

**Wax & Polish, cont.**



**ADPD005 . . . . .ALL**  
 "SWIRL & HAZE  
 REMOVER", Adam's  
 16 oz. Not a rubbing  
 compound and  
 less abrasive than  
 toothpaste. Gently  
 removes scratches  
 from clearcoats and  
 painted surfaces.

For use by hand or machine. For best  
 results, combine with Revive Polish.

8.800 -0.15

..... **\$26.00 EA** ⚠



**ADPD006 . . . . .ALL**  
 "BUTTER WAX",  
 Adam's 16 oz.  
 bottle. Contains  
 special blend of  
 polymers, resins and  
 natural Carnauba  
 without cleaners or  
 abrasives and will  
 not stain plastic or

rubber. Use Clay Bar and Revive Polish on  
 imperfect finishes before applying Butter  
 Wax. 12-oz bottle covers many vehicles.

8.800 -0.15

..... **\$19.99 EA** ⚠



**ADPD007 . . . . .ALL**  
 "BRILLIANT GLAZE",  
 Adam's 16 oz.  
 bottle. Add depth  
 and clarity to  
 chrome, glass and  
 paintwork. Extreme  
 ease of use with  
 ultra-high gloss  
 results. Not for use

on oxidized finishes. 8.800 -0.15

..... **\$25.00 EA** ⚠

**Wax & Polish, cont.**



**ADPD017 . . . . .ALL**  
 "FINE MACHINE  
 POLISH", Adam's 16  
 oz. Polish your car's  
 clearcoat to a jewel-  
 like finish. Designed  
 for application by  
 dual-action car  
 polishers. After just  
 one or two uses,

your clearcoat will have perfect clarity so  
 you can enjoy all of the rich color below.  
 Use it several times a year to maintain  
 perfect gloss, without thinning your  
 clearcoat.

To protect your finely polished finish,  
 follow up with Machine Super Wax or  
 Buttery Wax. Both products will add  
 additional gloss, depth and rich color.

8.800 -0.15

..... **\$25.00 EA** ⚠



**ADPD018 . . . . .ALL**  
 "MACHINE SUPER  
 SEALANT", Protect  
 your paint for  
 months in just a  
 matter of minutes.  
 Easy application  
 and built to last  
 through the toughest  
 elements.. 16oz.

8.800 -0.15

..... **\$25.00 EA** ⚠

**Metal Polish**



**ADPD009 . . . . .ALL**  
 "METAL POLISH  
 #1" Adam's Works  
 on stainless, brass,  
 billet, chrome, and  
 nickel (for use on  
 non-clear coated  
 parts). 8.800 -0.15

..... **\$19.99 EA** ⚠



**ADPD010 . . . . .ALL**  
 "METAL POLISH #2",  
 Adam's contains no  
 abrasives. Highest  
 gloss metal polish  
 on the market  
 w/ effortless  
 application. Keep  
 a mirror-like finish  
 on brass, stainless,  
 billet, nickel, and chrome. 8.800 -0.15

..... **\$47.29 EA** ⚠

**Dressing & Conditioners**



**ADPD002LR .37-64**  
 Pumpkin spice  
 scented "DETAIL  
 SPRAY", Adam's 16  
 oz. bottle. We use  
 this spray and it  
 works! A waterless  
 car wash, clay  
 bar lubricant or to  
 enhance the depth

and clarity of paint, chrome, plastic,  
 aluminum, and glass. Removes dirt,  
 smudges and grime, leaving surfaces  
 with a smooth, ultra-high gloss finish. Use  
 in the sun or shade, and in hot or cool  
 temperatures. 8.800 -0.15

..... **\$13.00 EA** ⚠



**ADPD020 . . . . .37-64**  
 "H2O Guard & Gloss" Adam's 16oz spray  
 bottle. Delivers lasting protection and  
 unmatched gloss in a unique water-  
 activated formula that's fast and easy to  
 apply. The patented blend of acrylic resins  
 and water activated nano-polymers leaves  
 your paint slick and protected. The optical  
 grade resins and detergent resistant  
 polymers provide months of protection for  
 any exterior surface including paint, trim,  
 and glass. -0.15

..... **\$17.00 EA** ⚠



**ADPD002 . . . . .ALL**  
 "DETAIL SPRAY",  
 Adam's 16 oz.  
 bottle. We use this  
 spray and it works! A  
 waterless car wash,  
 clay bar lubricant  
 or to enhance the  
 depth and clarity  
 of paint, chrome,

plastic, aluminum, and glass. Removes  
 dirt, smudges and grime, leaving surfaces  
 with a smooth, ultra-high gloss finish. Use  
 in the sun or shade, and in hot or cool  
 temperatures. 8.800 -0.15

..... **\$13.00 EA** ⚠

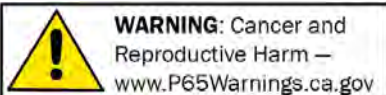

NOTE: Any chemicals will be shipped domestic ground only (Lower 48 states only). No international shipping.

**Dressing & Conditioners, cont.**



**ADPD003.....ALL**  
 "V.R.T." RUBBER DRESSING, Adam's 12 oz. bottle. Enhance & protect plastic, rubber, tires, moldings, dashboards and door panels. Applies easily with a sponge without a greasy film. Adds U.V. protection to keep vehicle interiors and exteriors looking and feeling like new. 8.800 -0.15

..... **\$25.00 EA** ⚠



**ADPD008.....ALL**  
 "LEATHER CONDITIONER", Adam's Nourish and conditions leather upholstery with this thick, non-greasy cream. Contains U.V. blocking agents and will never dry your leather. 16 oz. bottle. 8.800 -0.15

..... **\$27.25 EA** ⚠



**ADPD013.....ALL**  
 "IN & OUT SPRAY", Adam's restores badly faded plastic, rubber, flat painted surfaces and AC vents to their original luster and shine. 8.800 -0.15

..... **\$16.00 EA** ⚠



**ADPD016.....ALL**  
 "TIRE SHINE" Adam's Tire Shine gives you a Lustrous deep and Long lasting Shine or the Wet look. 8.800 -0.15

..... **\$17.00 EA** ⚠



**ADPG002.....ALL**  
 "DETAIL SPRAY", Adam's 1 gallon refill. We use this spray and it works! A waterless car wash, clay bar lubricant or to enhance the depth and clarity of

paint, chrome, plastic, aluminum, and glass. Removes dirt, smudges and grime, leaving surfaces with a smooth, ultra-high gloss finish. Use in the sun or shade, and in hot or cool temperatures. 8.800 -0.15

..... **\$38.50 EA** ⚠

**Dressing & Conditioners, cont.**



**ADPG003.....ALL**  
 "V.R.T." RUBBER DRESSING, Adam's 1 gallon refill. Enhance & protect plastic, rubber, tires, moldings, dashboards and door panels. Applies easily with a sponge without a greasy film. Adds U.V. protection to keep vehicle interiors and exteriors looking and feeling like new. 8.800 -0.15

..... **\$91.79 EA** ⚠

**303 Aerospace Protectant**

Keeps UV-sensitive materials "like new" year after year. It really is like "SPF 40 Sunscreen ... For Your Stuff." Regular use gives 100% Prevention of UV caused slow-fade with regular use. No other protectant beautifies as intensely, protects as powerfully or lasts as long.



**30340.....ALL**  
 Used on Rubber, Vinyl, Gelcoat fiberglass, plastics, acrylics, polycarbonates, carbon-fiber resin composites & finished leather. 8.800 -0.15

**30370.....ALL**  
 "303" Aerospace Protectant, "SPF 40" for your auto, 1 gallon refill. 8.800 -0.15

..... **\$73.00 EA** ⚠

**Clay Bar**



**ADPA001.....ALL**  
 "CLAY BAR", Adam's removes surface contamination without skid or swirl marks. The large 4-oz bar is suitable for 8-10 vehicles. 8.800 -0.15

..... **\$11.50 EA** ⚠

**Wash Pad**



**ADPP010.....ALL**  
 Adam's 10" Car Wash Pad. Made of plush synthetic wool to ensure you are washing without introducing new swirls or scratches! -0.15 **\$10.29 EA** ⚠

**Detail Sponge & Applicators**



**ADPA003.....ALL**  
 Large washable sponge applies a thin, even coat of Adam's Vinyl, Rubber, & Tire (V.R.T.) without the mess. 4 sponges. 8.800 -0.15

..... **\$8.00 SET** ⚠



**ADPM001.....ALL**  
 Large washable sponge. Adam's 8.800 -0.15

..... **\$9.25 SET** ⚠



**ADPTSPONGE .ALL**  
 Large washable detail sponge. Adam's 8.800 -0.15

..... **\$7.49 SET** ⚠



**ADPBRSWAB6.....ALL**  
 "Interior Detailing Swabs", Adam's 6 Pack 8.800 -0.15

..... **\$5.00 SET** ⚠



**ADPBRSWAB15.....ALL**  
 "Interior Detailing Swabs", Adam's 15 Pack 8.800 -0.15

..... **\$10.99 SET** ⚠



**Towels**

**ADPM0010** .....37-64  
 Adam's microfiber glass cleaning towel. Pairs perfectly with Adam's glass cleaner to leave a streak free surface. (2 Pack) -0.15 ..... **\$9.00 EA** ⚠️



**ADPM002** .....ALL  
 Adams Microfiber Polishing Towel is the softest, safest and most effective polishing towel on the market. Measuring 16" x 24", the thick yellow towel is ideal for removing polish and Detail Spray. We use two polishing towels for a standard detail. 8.800 -0.15 ..... **\$13.00 EA** ⚠️

**ADPM008** ....ALL  
 Ultra-soft waffle starfiber jumbo microfiber drying towel. 25" x 36". Adam's 8.800 -0.15 ..... **\$27.59 EA** ⚠️

**Polishing Ball**



**POWERBALL** ...ALL  
 Mother's "PowerBall" Use with your favorite polishing compound/ liquid on a drill/ screw gun to revitalize metal, plastic and more. 6" dia. 8.800 -0.15

..... **\$32.75 EA** ⚠️  
**POWERBALLM** .ALL  
 Mothers "PowerBall Mini" detail polishing ball with 10" extension for hard to reach areas. 3-1/4" dia. 8.800 -0.15 ..... **\$26.25 EA** ⚠️



**Tire Care**



**WHITEWIPE** .....ALL  
 Bleach free white wall tire wipes. 7" x 9" wipe. 35 per container. -0 ... **CALL** ⚠️

**Duster**

**DUSTER** .....ALL  
 California cotton duster w/ plastic handle. 8.800 -0.15 ..... **\$14.99 EA** ⚠️

**DUSTERW** .....ALL  
 California cotton duster w/ wood handle. 8.800 -0.15 ..... **\$21.75 EA** ⚠️

**Car Cover Flannel**  
 Soft, napped flannel to protect your finish. Woven cover constructed from durable polycotton blend. Breathable, rot & mildew resistant. Elastic at both ends for snug fit. Recommended for inside use only.



**306800F** .....35-56  
 Flannel. Specify year and model when ordering. 16.550 -0.15 ..... **starting at \$216.00 EA** ⚠️

**Car Cover Polycotton**  
 Basic vehicle protection. Woven cover constructed from durable polycotton blend. Breathable, rot & mildew resistant. Resists tares & punctures. Elastic at both ends for snug fit. Recommended for inside use only.  
**306800** .....35-56  
 Polycotton. Specify year and model when ordering. 16.550 -0.15 ..... **starting at \$185.00 EA** ⚠️

**Truck Cover Flannel**  
**306803F** ..... ALL  
 Flannel, 1/2T short bed. 16.550 -0.15 ..... **\$294.75 EA** ⚠️  
**306804F** ..... ALL  
 Flannel, long bed. 16.550 -0.15 ..... **\$298.59 EA** ⚠️

**Truck Cover Polycotton**



**306800A** .....ALL  
 Polycotton, 1/2T short bed. 16.550 -0.15 ..... **\$256.25 EA** ⚠️  
**306800T** ..... ALL  
 Polycotton, long bed. 16.550 -0.15 ..... **\$234.50 EA** ⚠️

**Car & Truck Cover Accessories**



**306800B** .....ALL  
 Storage bag. 16.550 -0.15 ..... **\$15.00 EA** ⚠️



**306800L** .....ALL  
 Lock set. 16.550 -0.15 ..... **\$14.99 EA** ⚠️

**Plastic Block**  
 Scaled, plastic block w/ steel inserts. Bolt on valve covers, exhaust headers, front engine pieces, intake, etc. Great for engine/chassis setup, garage display, education, coffee table, etc.



**PAP-2020** .....ALL  
 Chevy SB, long block w/heads. 0.000 -0.15 ..... **\$524.00 EA** ⚠️  
**PAP-2021** ..... ALL  
 Chevy SB, short block. 0.000 -0.15 ..... **\$524.00 EA** ⚠️  
**PAP-2041** ..... ALL  
 Harmonic balancer for Chevy SB. Mount crank pulley for front end clearance. 0.000 -0.15 ..... **\$56.00 EA** ⚠️

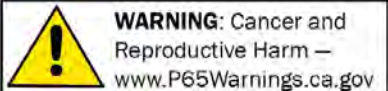

NOTE: Any chemicals will be shipped domestic ground only (Lower 48 states only). No international shipping.

**Plastic Block, cont.**



**PAP-2120** .....ALL  
Chevy BB, long block w/heads. 0.000 -0.15  
..... **\$616.00 EA** ⚠

**PAP-2121** ..... ALL  
Chevy BB, short block. 0.000 -0.15  
..... **\$431.00 EA** ⚠

**PAP-2125** ..... ALL  
Harmonic balancer for Chevy BB. Mount  
crank pulley for front end clearance.  
0.000 -0.15 ..... **\$56.00 EA** ⚠



**PAP-3020** .....ALL  
302 Ford long block w/heads. 0.000 -0.15  
..... **\$523.00 EA** ⚠



**PAP-3024** ..... ALL  
351 Ford Windsor long block w/heads.  
0.000 -0.15 ..... **\$523.00 EA** ⚠



**PAP-3035** ..... ALL  
352-390-427-428 Ford FE, Long Block  
0.000 -0.15 ..... **\$616.00 EA** ⚠

**PAP-3036** ..... ALL  
352-390-427-428 Ford FE, Short Block  
0.000 -0.15 ..... **\$431.00 EA** ⚠



**PAP-4020** .....ALL  
426 Chrysler Hemi Long Block w/heads.  
0.000 -0.15 ..... **\$616.00 EA** ⚠

**Plastic Block, cont.**

**PAP-4036** ..... ALL  
Mock Block Replica Engine. Mopar 440/  
Hemi, Dual Four Intake Manifold  
0.000 -0.15 ..... **\$74.00 EA** ⚠

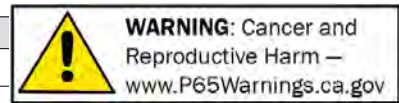

**Stainless Steel Tubing**



**SSTUBING.....ALL**  
304 seamless tubing in 1/2", 5/8" & 3/4" O.D. Can be cut to length. Total lengths up to 20 ft sticks (oversize shipping on long lengths). -0 ..... starting at **\$10.00 FT** ⚠

**Safety Wire Pliers**



**R809.....ALL**  
Safety Wire Pliers - 9". -0.15 . **\$30.00 EA** ⚠

**Battery Jump Starters**



**GB40.....ALL**  
Compact, yet powerful 1,000 Amp lithium-ion jump starter that delivers 7,000 Joules of starting power. Its patented safety technology features spark-proof technology and reverse polarity protection making it safe for anyone to use. Designed for use with gas engines up to 6 liters and diesel engines up to 3 liters and doubles as a portable power source for recharging smartphones, tablets and more. -0.15 ..... **\$128.00 EA** ⚠

**Battery Jump Starters, cont.**



**GB70.....ALL**  
The GB70 is a portable lithium-ion battery jump starter pack that delivers 2,000-amps (15,700 J3S) for jump starting a dead battery in seconds. It features a patented safety technology that provides spark-proof connections and reverse polarity protection making safe and easy for anyone to use. It's a powerful battery booster that doubles as a portable power source for recharging USB devices, like a smartphone, tablet and more, or powering 12-volt devices, like a tire inflator, power inverter and much more. And designed for a car, boat, RV, truck and more with gas engines up to 8 liters, and diesel engines up to 6 liters. -0.15 ... **\$258.00 EA** ⚠

**Genius Battery Chargers**



**G1100.....ALL**  
1.1 Amp UltraSafe Smart Battery Charger  
Charge fully drained lead-acid and lithium-ion batteries up to 40 amp-hour with zero overcharge - Stay safely connected 24/7.  
Ultimate performance and versatility. Charge 6-volt and 12-volt batteries, recover damaged batteries, suitable for micro-hybrid start-stop vehicles and works with CANBUS electrical systems.  
Ultra-compact, portable, energy-efficient design that's impact, UV and water-resistant (IP65).  
Actively monitors battery for safe and efficient charging. Includes spark-proof technology and reverse polarity protection.  
Advanced diagnostics automatically tests and detects a bad, damaged, or shorted battery. -0.15 .. **\$50.00 EA** ⚠

**Genius Battery Chargers, cont.**



**G3500.....ALL**  
3.5 Amp UltraSafe Smart Battery Charger  
Charge fully drained lead-acid and lithium-ion batteries up to 120 amp-hour with zero overcharge - Stay safely connected 24/7.  
Ultimate performance and versatility. Charge 6-volt and 12-volt batteries, recover damaged batteries, suitable for micro-hybrid start-stop vehicles and works with CANBUS electrical systems.  
Ultra-compact, portable, energy-efficient design that's impact, UV and water-resistant (IP65).  
Actively monitors battery for safe and efficient charging. Includes spark-proof technology and reverse polarity protection.  
Advanced diagnostics automatically tests and detects a bad, damaged, or shorted battery. -0.15 .. **\$72.00 EA** ⚠

**Battery Terminal Cleaner**



**10653CLNR .. ALL**  
For Top Post Batteries. -0.15 ..... **\$9.25 EA** ⚠

**Fender Cover**



**989936C .....ALL**  
Red CORVETTE script and logo. 19.980 -0.15 ..... **\$27.50 EA** ⚠



**989936CV .....ALL**  
Protect your pride and joy. Multi-color CORVETTE script. 19.980 -0.15 ..... **\$29.75 EA** ⚠

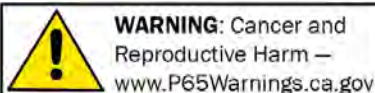

NOTE: Any chemicals will be shipped domestic ground only (Lower 48 states only). No international shipping.



**Adhesives & Sealers**



**1608** .....ALL  
3M plastic & emblem adhesive (5 oz. tube). 8.800 -0.15  
..... **\$20.00 EA** ⚠

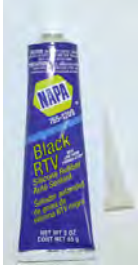

**1015BP** .....ALL  
Gasket sealer, high temp silicone. Black (3.35 oz tube). 8.800 -0.15  
..... **\$7.75 EA** ⚠



**511113** .....ALL  
Quality Spray adhesive for bowdrill cloth. Best product available for all interior trim. (14 oz. spray can). 8.800 -0.2  
..... **\$21.69 EA** ⚠



**511114** .....ALL  
3M, Black weatherstrip cement, 5-oz tube. Superior product!. 8.800 -0.2  
..... **\$20.00 EA** ⚠



**986199A** .....ALL  
3M Contact cement for rubber to metal. Bonds instantly. Industrial quality for gravel guards, running board rubber, etc. 8.800 -0.15  
..... **\$61.25 QT** ⚠



**GL14** .....ALL  
Windshield sealer. Seals leaks in new & old installation. Will not dry out rubber. Remains pliable. 8.991 -0.15  
..... **\$7.00 EA** ⚠

**Gas Tank Restoration Kit**



**PORTANK** .....ALL  
Portank, Restore your tanks. Cleaner, metal prep, sealer (Slosh) and instructions. 3.001 -0.15  
..... **\$84.50 KIT** ⚠

**Gas Tank Cleaner**

Works fast & makes petroleum-based cleaners nearly obsolete. Can be diluted with water up to 3, 4, 5 and even 10 times its volume while remaining more potent than other cleaners. Removes grease, oil, mildew, algae, musty odors, soap films & wax. Use it to clean canvas, vinyl, nylon, holding tanks, grease traps, auto parts and more.



**PORCLEAN** .....ALL  
Porclean, 1 quart. 3.001 -0.15  
..... **\$11.69 EA** ⚠

**Metal Prep**

Provides adhesion for POR-15 paint (Sect. 15) on aluminum and shiny polished metal surfaces. Etches metal and leaves a zinc phosphate coating. Non-caustic, non-corrosive, non-toxic & non-flammable.



**PORMETAL** .....ALL  
Etches Metal and Leaves a Zinc Phosphate Coating. Provides the best adhesion for POR-15 on any metal surface. Water based,

OSHA approved biodegradable solution. 3.001 -0.15

..... **\$16.99 QT** ⚠

**Gas Tank Sealer Slosh**



**3657942C** .....ALL  
Gas tank sealer slosh, seals gas tank. Alcohol and Ethanol proof. Not for use with (MEK) Methyl Ethyl Ketone. 3.001 -0.15  
..... **\$32.25 QT** ⚠

**Fuel Stabilizer**

Keep fuel fresh. Removes water, cleans carburetors & fuel injectors. Protects engine from gum, varnish, rust, and corrosion. Eliminates need to drain fuel before storage. Special dispenser bottles measure exactly without waste. Contains NO alcohol.



**111801** .....ALL  
STA-BIL stabilizer. 8 oz bottle treats 20 gallons, for one year. 3.001 -0  
..... **\$8.25 EA** ⚠



**111801B** .....ALL  
STA-BIL fuel stabilizer. 32 oz bottle treats 80 gallons, for one year. 3.001 -0.15  
..... **\$21.00 EA** ⚠

**Rust Preventer**



**RPM8** .....ALL  
This is liquid Rust Preventative Magic in an 8 ounce tub. The new wax-like product is easy to apply and will protect bare metal from rusting. It will not reverse rust or remove it, so you will need to sandblast or glass bead any rusty parts clean first. -0.15  
..... **\$35.09 EA** ⚠

**Rust Remover**



**1001PL . . . . .ALL**  
Rust Remover. Works great, is biodegradable and non-caustic. Our shop loves this product. Great for cleaning inside gas tanks. Sold as a concentrate that

makes 3 gallons. 8.800 -0.15

..... **\$30.00 EA** ⚠️

**Carburetor Cleaner**



**6505259 . . . . .ALL**  
This is great carburetor cleaner in a spray can. Can also be used to clean other small parts and as a degreaser., 16 oz spray can. 3.725 -0.15

..... **\$5.50 EA** ⚠️

**Brake Cleaner**



**6129423 . . . . .ALL**  
The professional's choice brake cleaner. Comes in a 18 ounce spray can and is a superior product. It's made to clean brake parts but also makes a great degreaser for

cleaning various parts. 18 oz. 4.683 -0.2

..... **\$4.00 EA** ⚠️

**Brake Fluid**



**5450285B . . . . .ALL**  
Master "Fade Free" DOT 4 (12 oz).

4.683 -0.15

..... **\$4.50 EA** ⚠️



**603486B . . . . .ALL**  
Mac's, DOT 5, silicone. Less corrosion. 12 ounce bottle. 4.683 -0.15

..... **\$10.25 EA** ⚠️

**Lubricator & Bolt Loosener**



**PBBLASTER. . . . .ALL**  
Powerful rust inhibitor, bolt loosener/penetrant. -0.15

..... **\$9.50 EA** ⚠️

**Oil Pad**



**OILPAD . . . . .ALL**  
Absorbs oil, water, etc. Holds approx 1 gallon (3 ft x 3 ft). 8.821 -0.15

**\$16.50 EA** ⚠️

**OILPAD1 . . . . .ALL**  
Absorbs oil, water, etc. Holds over 1 gallon. (3 ft x 5 ft). 8.821 -0.15

**\$22.49 EA** ⚠️

Tip: Store spray cans upside down for long term storage. Setting in warm water prior to painting helps paint flow.

**POR-15 Rust Preventative Paint**



**POR-15QT . . . . .ALL**  
1 quart. POR-15 Rust-preventative coating applied directly over rusted or seasoned metal surfaces. Dries as rock hard, nonporous finish that won't chip, crack or peel. Prevents rust from reoccurring. Choose Black, Semi-Gloss Black, Grey, Silver or Clear. 8.800 -0

..... **\$48.50 QT** ⚠️

**POR-15 Rust Paint Solvent**



**POR-15QTSLV . . . . .ALL**  
Thinner. Use for easy cleanup or thinning of POR-15 paint. 8.800 -0.15

..... **\$14.50 QT** ⚠️

**Clear Coat Paint**



**10200Z . . . . .ALL**  
Gloss Clear Coat For Bare Metal Surfaces. Great for use on polished metal to keep the shine. 8.800 -0.15

..... **\$21.00 EA** ⚠️

**Paint Zero Rust**



**511112C . . . . .ALL**  
Satin black w/ rust inhibitors. Use on core supports, inner fender panels, etc. (12 oz. spray). Match to GM satin black. 8.800 -0.15

..... **\$19.00 EA** ⚠️

**Paint Engine**



**986959S . . . . .29-52**  
Chevy Engine Grey hi-temp (16 oz. spray can). Color has been tested and is correct. 8.800 -0.15

..... **\$28.25 EA** ⚠️

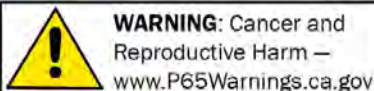

NOTE: Any chemicals will be shipped domestic ground only (Lower 48 states only). No international shipping.

**Paint Engine, cont.**



**986970S . . . .53-62**  
Chevy Engine Blue  
(12-3/4 oz. spray  
can). 8.800 -0.15  
..... **\$22.49 EA** ⚠

**VHT Hi-Temp Engine Enamel**



**986959B . . . . .ALL**  
VHT Hi-Temp Gloss  
Black Engine  
enamel (11 oz. spray  
can). 8.800 -0.15  
..... **\$9.49 EA** ⚠



**986959FB . . . . .ALL**  
VHT Hi-Temp Flat  
Black Engine  
enamel (11 oz. spray  
can). 8.800 -0.15  
..... **\$9.00 EA** ⚠



**9869590 . . . . .ALL**  
VHT Hi-Temp Chevy  
Orange enamel  
(12 oz. spray can).  
8.800 -0.15  
..... **\$10.75 EA** ⚠



**986959R . . . . .ALL**  
VHT Hi-Temp  
Universal Red  
Engine enamel  
(11 oz. spray can).  
8.800 -0.15  
..... **\$9.00 EA** ⚠



**986959SB . . . . .ALL**  
VHT Hi-Temp Chevy  
GM Satin Black  
Engine enamel  
(11 oz. spray can).  
8.800 -0.15  
..... **\$12.00 EA** ⚠

**VHT Hi-Temp Engine Enamel, cont.**



**986959UA . . . . .ALL**  
VHT Hi-Temp  
Universal Aluminum  
Engine enamel  
(11 oz. spray can).  
8.800 -0.15  
..... **\$10.49 EA** ⚠

**Paint Cast Blast**



**3657963D . . . . .ALL**  
Cast blast paint  
high temp 1200  
degree. Grey, fresh  
cast look for exhaust  
manifolds, etc. Rust  
preventative, 11 oz  
spray can. 3.609 -0.15  
..... **\$14.75 EA** ⚠



**3657963F . . . . .ALL**  
Grey cast color paint,  
For non high heat  
applications. Gives  
fresh cast look. Rust  
preventative, 11 oz  
spray can. 3.609 -0.15  
..... **\$7.99 EA** ⚠

**Paint Inner Fender Panel**



**511112D . . . . .ALL**  
Flat black spray  
paint for use on  
core supports and  
inner fender panels.  
8.800 -0.15  
..... **\$10.50 EA** ⚠

**Paint Exhaust**



**3657963C . . . . .ALL**  
Exhaust paint  
stainless steel  
pigments. For  
exhaust manifolds &  
pipes. Gives a soft  
grey, metallic finish.  
Pint 3.609 -0  
..... **CALL** ⚠



**3657963E . . . . .ALL**  
Exhaust paint clear,  
high temp (1200  
degree) for exhaust  
etc, 11 oz spray can.  
3.609 -0.15  
..... **\$14.00 EA** ⚠

**Paint Exhaust, cont.**



**3657963FA . . . . .ALL**  
Exhaust paint  
very high temp,  
flat aluminum for  
manifolds & pipes.  
11 oz spray can.  
3.609 -0.15  
..... **\$14.19 EA** ⚠

**Sound Deadener Thermal Protection**

For complete vehicle specific sound & vibration dampning kits see Section 320.



**DEADENER . . . . .ALL**  
Engineered for the  
interior & exterior  
side of body panels.  
200% decrease in  
noise & vibration.  
Bonds to metal,  
fiberglass & wood.  
Covers 30 sq. ft.  
..... **\$85.00 GALLON** ⚠

8.800 -0.15



**SPRAYGUN . . . . .ALL**  
Spray gun. Siphon-  
feed spray gun  
for DEADENER.  
8.800 -0.15  
..... **\$89.25 EA** ⚠



**VB-1SPRO . . . . .ALL**  
For exterior  
automotive panels  
such as inside  
fender wells, wheel  
arches and  
underside of the  
floor pan. Converts  
structural resonance  
and vibration into

low level heat through friction. It remains soft which allows it to absorb the impact of road debris. (NOTE: Only apply to exterior surfaces due to prolonged outgassing). 18 oz. aerosol can. Covers 4 sq. ft. 8.800 -0.15 ..... **\$14.50 EA** ⚠

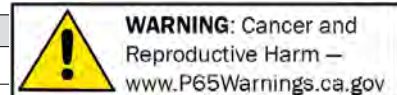

**Crate Motors**

These engines drop ship from manufacturer. Please call for shipping charges.

**Crate Engines GM SB Aluminum Heads**

Oversize shipping charges apply. Please call for rate.

Details for our GM ALUMINUM HEAD Crate Motors:

**ROTATING ASSEMBLY:**

- New SCAT crankshafts.
- New SCAT I-beam rods w/ 150,000 psi bolts.
- Hastings moly rings.
- Balanced rotating assembly.
- Melling high volume oil pump.
- Flat tappet hydraulic lifter cam.
- Clevite 77 bearings.
- Heavy duty double roller timing set.

**CYLINDER HEADS:**

- New DART aluminum cylinder heads.
- 1.437 dia. valve springs.
- Hardened retainers & keepers.
- 2.02 swirl polished intake valves.
- 1.60 swirl polished exhaust valves.
- Hardened push rods.

**INCLUDES EXTRAS:**

- Signature Series aluminum valve covers.
- Aluminum dual plane satin finish intake manifold (carb applications).
- 9.5 to 1 compression ratio.
- Brass freeze plugs.



**BP335513CT1** .....ALL  
390hp, 355ci. Includes Holley 600cfm carb and ignition system. Torque = 410ft-lbs. 0.000-0 ... \$4,459.00 EA ⚠



**BP35513CTF1** .....ALL  
390Hp Includes F.A.S.T. EZ Fuel Injection and Ignition System 410 Tq 0.000-0 ..... \$5,259.00 EA ⚠

**Crate Engines GM SB Vortec Heads**

Oversize shipping charges apply. Please call for rate.



**BP3550CT** .....ALL  
385hp, 355ci. Torque = 405ft-lbs. 0.000-0 ..... \$3,345.00 EA ⚠



**BP3550CTC1** .....ALL  
385hp, 355ci. Includes Holley 600cfm carb and ignition system. Torque = 405ft-lbs. 0.000-0 .. \$4,499.00 EA ⚠

**Crate Engines GM SB Aluminum Heads "Budget Stomper"**



**BP35512CT1** .....ALL  
375hp, 355ci. Torque = 400ft-lbs. 0.000-0 ..... \$3,245.00 EA ⚠



**BP35512CTC1** .....ALL  
375hp, 355ci. Includes Holley 600cfm carb and ignition system. Torque = 400ft-lbs. 0.000-0 .. \$3,950.00 EA ⚠

**Crate Engines GM SB Stroker Aluminum Heads "Budget Stomper"**

**BP38313CT1** .....ALL  
420hp, 383ci. Torque = 450ft-lbs. 0.000-0 ..... \$4,499.00 EA ⚠

**Crate Engines GM SB Stroker Vortec Heads**



**BP3830CT1** .....ALL  
405hp, 383ci. Torque = 440ft-lbs. 0.000-0.15 ..... \$3,999.00 EA ⚠



**BP3830CTC1** .....ALL  
405hp, 383ci. Included Holley 750cfm carb and ignition system. Torque = 440ft-lbs. 0.000-0.15 ..... \$5,999.00 EA ⚠

**Crate Engines GM SB Stroker Vortec Heads w/ Roller Cam**



**BP3833CT1** .....ALL  
420hp, 383ci. Torque = 450ft-lbs. 0.000-0 ..... \$3,850.00 EA ⚠



**BP3833CTC1** .....ALL  
420hp, 383ci. Includes Holley 750 Cfm carb and ignition system. Torque = 440ft-lbs. 0.000-0 .. \$5,025.00 EA ⚠

**Crate Engines GM SB Stroker Aluminum Heads**



**BP38317CT1** .....ALL  
445hp, 383ci. SCAT Forged Crank with Probe Forged Pistons. Torque = 463ft-lbs. 0.000-0 ..... \$7,199.00 EA ⚠

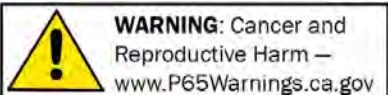

NOTE: Any chemicals will be shipped domestic ground only (Lower 48 states only). No international shipping.

**Crate Engines GM SB Stroker Aluminum Heads**



**BP38318CTF1** .....**ALL**  
 438hp, 383ci. Includes F.A.S.T. EZ EFI and ignition system. Torque = 443ft-lbs.  
 0.000 -0 ..... **\$6,299.00 EA** ⚠️  
**BP3834CTC** ..... **ALL**  
 420hp, 383ci. Includes Holly 750cfm carb and ignition system. Torque = 450ft-lbs. 0.000 -0.15 ... **\$4,999.00 EA** ⚠️



**BP383CTC1** .....**ALL**  
 430Hp Includes Holley 750 Cfm Carb and ignition System 450Tq -0  
 ..... **\$4,999.00 EA** ⚠️

**Crate Engines GM BB Iron Heads**



**BP4963CT** .....**ALL**  
 480hp, 496ci. Torque = 550ft-lbs. 0.000 -0  
 ..... **\$4,945.00 EA** ⚠️



**BP4963CTC** .....**ALL**  
 480hp, 496ci. Includes Holley 800Cfm Carb and ignition system Torque = 550ft-lbs. 0.000 -0 ..... **\$5,945.00 EA** ⚠️

**Crate Engines FORD 347ci Iron Heads**

Details for our FORD IRON HEAD Crate Motors:

ROTATING ASSEMBLY:  
 New SCAT cast crankshaft.  
 New SCAT rods w/ 150,000 psi bolts.  
 Keith Black Hypereutectic pistons.  
 Hastings Moly rings.  
 Balanced rotating assembly.  
 Melling high volume oil pump.  
 Flat tappet hydraulic lifter camshaft.  
 Heavy duty double roller timing sets.

CYLINDER HEADS:  
 Modified Ford cast iron heads.  
 1.25 dia valve springs.  
 Hardened retainers & keepers.  
 2.02 swirl polished intake valves.  
 1.60 swirl polished exhaust valves.  
 Hardened push rods.

INCLUDES EXTRAS:  
 New chrome valve covers.  
 Aluminum dual plane high-rise intake manifold (carb applications).  
 9.5 to 1 compression ratio.  
 Brass freeze plugs.  
 Oversize shipping charges apply. Please call for rate.



**BP3472CTC** .....**ALL**  
 330hp, 347ci. Includes Holley 600cfm carb and ignition system. Torque = 380ft-lbs. 0.000 -0 .. **\$5,299.99 EA** ⚠️

**Crate Engines FORD 347ci Aluminum Heads**



**BP3474CTF** .....**ALL**  
 400hp, 347ci. SCAT Cast Crank with Probe Hyperutectic Pistons. F.A.S.T. EZ EFI and ignition system. Torque = 425ft-lbs. 0.000 -0 ..... **\$6,699.00 EA** ⚠️

**Crate Engines MOPAR 408ci - Aluminum Heads**

Details for our MOPAR ALUMINUM HEAD Crate Motors:

Block:  
 Seasoned 360 block.  
 Square and parallel decked.  
 Align honed main bearing bore.  
 Cylinders honed on computer controlled machine to within .0002 straightness and roundness.  
 Cylinders are sonic tested for thickness.

Rotating Assembly:  
 New SCAT cast iron crankshaft.  
 Keith Black forged pistons.  
 SCAT H-beam rods with 150,000 psi ARP bolts.  
 Hastings Moly rings.  
 Balanced rotating assembly.  
 Melling high volume oil pump.  
 Flat tappet hydraulic lifter camshaft.  
 Heavy duty double roller timing set.

Cylinder Heads:  
 EDELBROCK Aluminum Performer RPM heads.  
 1.437 diameter valve springs.  
 Hardened retainers and springs.  
 2.02 swirl polished intake valves.  
 1.60 swirl polished exhaust valves.  
 Hardened push rods.

A Ton Of Extras:  
 EDELBROCK RPM Air-Gap Intake.  
 New chrome "MOPAR PERFORMANCE" valve covers.  
 Brass freeze plugs.  
 Oversize shipping charges apply. Please call for rate.

**BPC4083CT** .....**ALL**  
 445hp, 408ci. Torque = 500ft-lbs. 0.000 -0 ..... **\$6,749.00 EA** ⚠️

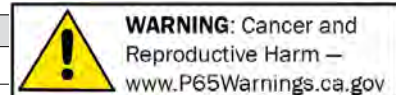

## Section 020: Crate Engines, Chevy, Ford & Mopar

### Section 022: Valve Covers, Breathers, Engine Accessories

#### Crate Engines MOPAR Magnum Heads

Details for our MOPAR IRON HEAD Crate

Motors:

Block:

Seasoned 360 block.

Square and parallel decked.

Align honed main bearing bore.

Cylinders honed on computer controlled machine to within .0002 straightness and roundness.

Cylinders are sonic tested for thickness.

Rotating Assembly:

New SCAT cast iron crankshaft.

Keith Black forged pistons.

SCAT H-beam rods with 150,000 psi ARP bolts.

Hastings Moly rings.

Balanced rotating assembly.

Melling high volume oil pump.

Flat tappet hydraulic lifter camshaft.

Heavy duty double roller timing set.

Cylinder Heads:

BluePrint magnum cast iron heads

Hardened retainers and springs

1.92" swirl polished intake valves

1.625" swirl polished exhaust valves

Hardened push rods†.

A Ton Of Extras:

EDELBROCK RPM Air-Gap Intake.

New chrome "MOPAR PERFORMANCE" valve covers.

Brass freeze plugs.



#### BPC4082CT .....ALL

375hp, 408ci Magnum (cast iron) heads.

Torque = 460ft-lbs. 0.000 -0

..... \$4,999.00 EA ⚠

#### Crate Engines MOPAR Magnum Heads



#### BPC4082CTC .....ALL

395hp, 408ci Magnum (cast iron) heads.

Includes Holley 750cfm carb and ignition system. Torque = 460ft-lbs. 0.000 -0

..... \$5,999.00 EA ⚠

#### Engine Dress Kits Chevy



#### R3024 .....ALL

Chrome SB Chevy Engine Dress-Up Kit - Tall Valve Cover.

Fits 58-86 SB Chevy, 283-350

1 pair chrome steel valve covers (baffled)

1 chrome steel timing chain cover

1 chrome steel timing tab

1 chrome steel engine dipstick with tube

1 chrome steel push-in breather cap

1 rubber push-in breather & PCV

grommet -0.15 ..... \$50.68 SET ⚠



#### R3026 .....ALL

Chrome BB Chevy Engine Dress-up Kit - Tall Valve Cover

Fits 65-95 BB Chevy, 396-502

1 pair chrome steel valve covers (baffled)

1 chrome steel timing chain cover

1 chrome steel timing tab

1 chrome steel engine dipstick with tube

1 chrome steel push-in breather cap

1 rubber push-in breather & PCV

grommet -0.15 ..... \$67.11 SET ⚠



#### R3036 .....ALL

FLAME BB Chevy Engine Dress-up Kit

Fits 65-95 BB Chevy, 396-502

1 pair chrome steel "FLAME" tall valve covers (baffled)

1 chrome steel timing chain cover

1 chrome steel timing tab

1 chrome steel engine dipstick with tube

1 chrome steel "FLAME" push-in breather cap

1 rubber push-in breather & PCV

grommet -0.15 ..... \$71.13 SET ⚠



**WARNING:** Cancer and Reproductive Harm —  
www.P65Warnings.ca.gov

NOTE: Any chemicals will be shipped domestic ground only (Lower 48 states only). No international shipping.

(800) 952-1752 • www.streetrodhq.com

**Engine Dress Kits Chevy, cont.**



**R3037.....ALL**  
**FLAME BB Chevy Engine Dress-up Kit**  
 Fits 65-95 BB Chevy, 396-502  
 1 pair chrome steel "FLAME" short valve covers (baffled)  
 1 chrome steel timing chain cover  
 1 chrome steel timing tab  
 1 chrome steel engine dipstick with tube  
 1 chrome steel "FLAME" push-in breather cap  
 1 rubber push-in breather & PCV grommet -0.15 ..... **\$68.46 SET** ⚠

**Engine Dress Kits Chevy Truck**



**R3125.....ALL**  
**85-UP Small Block Chevy Truck Dress-up Kit. Single wing nut air cleaner.**  
 1 pair chrome steel short valve cover "caps"  
 (caps fit over existing OEM valve covers)  
 1 chrome steel timing chain cover  
 1 chrome steel air cleaner top  
 1 chrome plastic brake cylinder top cover  
 1 chrome plastic power steering cap cover  
 1 chrome plastic screw-in oil cap -0.15 ..... **\$84.55 SET** ⚠



**R3126.....ALL**  
**Chrome Small Block Engine Dress-Up Kit -85-UP Chevy Truck. Dual wing nut air cleaner.**  
 1 pair chrome steel short valve cover "caps"  
 (caps fit over existing OEM valve covers)  
 1 chrome steel timing chain cover  
 1 chrome steel air cleaner top  
 1 chrome plastic brake cylinder top cover  
 1 chrome plastic power steering cap cover  
 1 chrome plastic screw-in oil cap -0.15 ..... **\$81.49 SET** ⚠

**Engine Dress Kits Chrysler**



**R3029.....ALL**  
**Chrome SB Chrysler Engine Dress-up Kit - Short Valve Cover. -0.15**  
 ..... **\$66.99 SET** ⚠

**Engine Dress Kits Ford**



**R3025.....ALL**  
**Chrome SB Ford Engine Dress-up Kit**  
 Fits 1962-85 SB 260, 289, 302, 351W & 5.0L  
 Each kit contains  
 1 pair chrome steel valve covers (baffled)  
 12 chrome steel valve cover wing nuts  
 12 chrome steel valve cover mini tabs  
 2 chrome steel push-in breather caps  
 2 rubber push-in breather grommets -0.15 ..... **\$77.99 SET** ⚠



**R3035.....ALL**  
**Chrome FLAME SB Ford Engine Dress-up Kit**  
 Fits 1962-85 SB 260, 289, 302, 351W & 5.0L  
 Each kit contains  
 1 pair chrome steel "FLAME" valve covers (baffled)  
 12 chrome steel valve cover wing nuts  
 12 chrome steel valve cover mini tabs  
 2 chrome steel "FLAME" push-in breather caps  
 2 rubber push-in breather grommets -0.15 ..... **\$77.90 SET** ⚠

**Engine Dress Kits Pontiac**



**R3030.....ALL**  
**Chrome Pontiac Engine Dress-up Kit. Fits 1959-77 301-455**  
 Each kit contains  
 1 pair chrome steel valve covers (baffled)  
 8 chrome steel valve cover wing nuts  
 8 chrome steel valve cover spreader bars  
 1 chrome steel push-in breather caps  
 1 rubber push-in breather grommets  
 1 rubber PCV grommet -0.15 ..... **\$67.10 SET** ⚠

**Valve Covers**

See our complete line of valve covers on our website [www.streetrodhq.com](http://www.streetrodhq.com)

**Valve Cover Adapters For LS Engines**

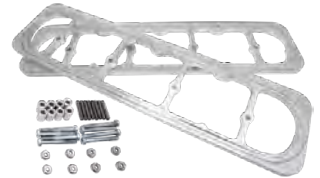

**BIS95030.....ALL**  
 Allows the use of standard small block Chevrolet valve covers on a LS motor for a classic look -0.15 ..... **\$165.19 PR** ⚠



**BIS95037.....ALL**  
 The LS Valve Cover Conversion kit allows the use of perimeter style small block Chevrolet valve covers on an LS motor while hiding the coils underneath for a classic clean look. Recessed wire channels drop the wires where you need them for ease of installation -0 ..... **\$499.00 EA** ⚠

**Valve Covers Aluminum Chevy Small Block**

The following Aluminum Chevy SB valve covers come baffled and include grommets.



**R6030-1**.....ALL  
Polished Aluminum SB Chevy Tall Valve Cover - Plain w/o Hole & Baffled (Includes Grommets). -0.15 ..... **\$92.49 PR** ⚠

**R6031-1**.....ALL  
Polished Aluminum SB Chevy Short Valve Cover - Plain w/o Hole & Baffled (Includes Grommets). -0.15 ..... **\$86.50 PR** ⚠

**R6130**.....ALL  
Polished Aluminum SB Chevy Tall Valve Cover - Ball Milled with Hole & Baffled (Includes Grommets). -0.15 ..... **\$114.75 PR** ⚠



Shown with breather R6505 for display purposes

**R6186**.....ALL  
Polished Aluminum SB Chevy 1957-86 "Finned" Valve Cover - Short with Hole. -0.15 ..... **\$147.50 PR** ⚠

**Valve Covers Billet Specialties Chevy Small Block**

Billet Specialties polished aluminum valve covers are available in both short and tall heights with a 1.220in. diameter breather hole. Use tall covers if using roller rockers and stud girdles. Metal Baffles are included with all small block valve covers. Quality die cast aluminum polished to Billet Specialties standards and CNC machined in house. Choose matching breathers, wire looms, radiator cap & air cleaner to finish off your engine compartment.



**BIS95120**.....ALL  
Ball milled, polished. Short (2-3/4in height). 0.386 -0.15 ..... **\$110.25 PR** ⚠

**Valve Covers Billet Specialties Chevy Small Block, cont.**



**BIS95121**.....ALL  
Bowtie, polished. Short (2-3/4in height). 0.386 -0.15 ..... **\$135.00 PR** ⚠



**BIS95122**.....ALL  
Chevy Power, polished. Short (2-3/4in height). 0.386 -0.15 ..... **\$135.25 PR** ⚠



**BIS95123**.....ALL  
Chevrolet script, polished. Short (2-3/4in height). 0.386 -0.15 ..... **\$135.00 PR** ⚠



**BIS95127**.....ALL  
Cross Flags, polished. Short (2-3/4in height). 0.386 -0.15 ..... **\$135.25 PR** ⚠



**BIS95129**.....ALL  
Smooth, polished. Short (2-3/4in height). 0.386 -0.15 ..... **\$90.00 PR** ⚠



**BIS95220**.....ALL  
Ball milled, polished. Tall (3-3/4in height). 0.386 -0.15 ..... **\$110.25 PR** ⚠

**Valve Covers Billet Specialties Chevy Small Block, cont.**



**BIS95221**.....ALL  
Bowtie, polished. Tall (3-3/4in height). 0.386 -0.15 ..... **\$135.00 PR** ⚠



**BIS95221BLK**.....ALL  
Bowtie, powdercoated black. Tall (3-3/4in height). 0.386 -0.15 ..... **\$160.00 PR** ⚠



**BIS95222**.....ALL  
Bowtie, polished. Tall (3-3/4in height). 0.386 -0.15 ..... **\$135.25 PR** ⚠

**BIS95223**.....ALL  
Chevrolet Script, polished. Tall (3-3/4in height). 0.386 -0.15 ..... **\$135.25 PR** ⚠



**BIS95223BLK**.....ALL  
Chevrolet Script, black powder coated. Tall (3-3/4in height). 0.386 -0.15 ..... **\$160.25 PR** ⚠



**BIS95224**.....ALL  
Streamline Series. Set yours apart from the rest. Black Powdercoated. Tall. 0.386 -0.15 ..... **\$235.00 PR** ⚠

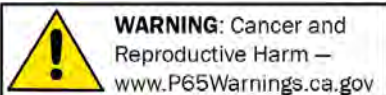

**WARNING:** Cancer and Reproductive Harm — [www.P65Warnings.ca.gov](http://www.P65Warnings.ca.gov)

NOTE: Any chemicals will be shipped domestic ground only (Lower 48 states only). No international shipping.



# Section 022: Valve Covers, Breathers, Engine Accessories

## Valve Covers Billet Specialties Chevy Small Block, cont.



**BIS95224RTF** .....ALL  
Streamline Series. We prepped it... You  
paint it. Tall 0.386-0.15     **\$235.00 PR** ⚠



**BIS95227** .....ALL  
Cross Flags, polished. Tall (3-3/4in height).  
0.386-0.15     **\$135.25 PR** ⚠

## Valve Covers Billet Specialties Chevy Big Block



**BIS96020** .....ALL  
Ball milled, polished. Short (2-3/4in  
height). With bolts. 0.386-0.15  
..... **\$190.00 PR** ⚠



**BIS96021** .....ALL  
Bowtie Polished. Short (3-3/4in height).  
With bolts. 0.386-0.15     **\$195.00 PR** ⚠



**BIS96022** .....ALL  
"Chevy Power" Polished. Short (3-3/4in  
height). With bolts. 0.386-0.15  
..... **\$195.00 PR** ⚠

## Valve Covers Billet Specialties Chevy Big Block, cont.



**BIS96023** .....ALL  
Chevrolet Script Polished. Short (3-3/4in  
height). With bolts. 0.386-0.15  
..... **\$195.00 PR** ⚠



**BIS96027** .....ALL  
Cross Flags Polished. Short (3-3/4in  
height). With bolts. 0.386-0.15  
..... **\$195.00 PR** ⚠



**BIS96028** .....ALL  
Flamed, polished. Short (2-3/4in height).  
With bolts. 0.386-0.15     **\$180.00 PR** ⚠



**BIS96120** .....ALL  
Ball milled, polished. Tall (3-3/4in height).  
With bolts. 0.386-0.15     **\$190.00 PR** ⚠



**BIS96121** .....ALL  
Bowtie Polished. Tall (3-3/4in height). With  
bolts. 0.386-0.15     **\$195.00 PR** ⚠

## Valve Covers Billet Specialties Chevy Big Block, cont.



**BIS96121BLK** .....ALL  
Bowtie Powdercoated black. Tall (3-3/4in  
height). With bolts. 0.386-0.15  
..... **\$200.00 PR** ⚠



**BIS96122** .....ALL  
"Chevy Power" Polished. Tall (3-3/4in  
height). With bolts. 0.386-0.15  
..... **\$195.00 PR** ⚠



**BIS96123** .....ALL  
Chevrolet Script Polished. Tall (3-3/4in  
height). With bolts. 0.386-0.15  
..... **\$195.00 PR** ⚠



**BIS96123BLK** .....ALL  
Chevrolet Script Polished. Tall (3-3/4in  
height). With bolts. 0.386-0.15  
..... **\$210.00 PR** ⚠



**BIS96124** .....ALL  
Streamline Series Black Powdercoated.  
Tall and completely original. 0.386-0.15  
..... **\$260.00 PR** ⚠

**Valve Covers Billet Specialties Chevy Big Block, cont.**



**BIS96124RTF** .....ALL  
Streamline Series We Prepped it... You Paint It. Tall and completely original. 0.386 -0.15 ..... **\$260.00 PR** ⚠



**BIS96127** .....ALL  
Chevrolet Script Polished. Tall (3-3/4in height). With bolts. 0.386 -0.15 ..... **\$195.00 PR** ⚠



**BIS96129** .....ALL  
Smooth, polished. Tall (3-3/4in height). With bolts. 0.386 -0.15 ..... **\$170.00 PR** ⚠

**Valve Covers Billet Specialties Chevy Center Bolt**



**BIS95727** .....ALL  
Cross Flags, polished. Tall (3-3/4in height). 0.386 -0.15 ..... **\$185.00 PR** ⚠



**BIS95820** .....ALL  
Ball milled, polished. Short (2-3/4in height). 0.386 -0.15 ..... **\$160.00 PR** ⚠

**Valve Covers Billet Specialties Chevy Center Bolt, cont.**



**BIS95827** .....ALL  
Cross Flags, polished. Short (2-3/4in height). 0.386 -0.15 ..... **\$165.00 PR** ⚠



**BIS95829** .....ALL  
Smooth, polished. Short (2-3/4in height). 0.386 -0.15 ..... **\$140.00 PR** ⚠

**Valve Covers Aluminum Chevy Center Bolt**



**R6046** .....ALL  
Polished Alum SB Chevy Center Bolt Tall Valve Cover - Plain w/o Hole & Unbaffed (Grommets & Bolts). -0.15 ..... **\$107.50 PR** ⚠



**R6191** .....ALL  
Polished Aluminum SB Chevy 1987-up "Finned" Valve Cover - Tall with Hole. -0.15 ..... **\$138.00 PR** ⚠



**R6196** .....ALL  
Polished Aluminum SB Chevy 1987-up "Finned" Valve Cover - Short with Hole. -0.15 ..... **\$167.00 PR** ⚠

**Valve Covers Aluminum Chevy LS**



**BIS95450** .....ALL  
LS Chevy without coils. Polished Ribbed. 0.386 -0.15 ..... **\$595.00 PR** ⚠



**BIS95459** .....ALL  
LS Chevy without coils. Polished smooth finish. 0.386 -0.15 ..... **\$450.00 PR** ⚠



**BIS95460** .....ALL  
LS1 Chevy. Hide those coils. 0.386 -0.15 ..... **\$1,095.00 PR** ⚠



**BIS95465** .....ALL  
LS1 Chevy. Hide those coils. 0.386 -0.15 ..... **\$1,250.00 PR** ⚠



**BIS95470** .....ALL  
LS3 Chevy. Hide those coils. 0.386 -0.15 ..... **\$1,095.00 PR** ⚠



**BIS95475** .....ALL  
LS3 Chevy. Hide those coils. 0.386 -0.15 ..... **\$1,250.00 PR** ⚠



**WARNING:** Cancer and Reproductive Harm — [www.P65Warnings.ca.gov](http://www.P65Warnings.ca.gov)

NOTE: Any chemicals will be shipped domestic ground only (Lower 48 states only). No international shipping.

**(800) 952-1752 • www.streetrodhq.com**

**Valve Covers Aluminum Chevy LS, cont.**



- R6139**.....ALL  
Fabricated GM LS Valve Cover & Coil Pack Cover -0.15 ..... **\$199.00 EA** ⚠️  
**R6142**.....ALL  
Brushed. Includes bolts & gaskets. -0.15 ..... **\$207.00 PR** ⚠️  
**R6142POL**.....ALL  
Polished. Includes bolts & gaskets. -0.15 ..... **\$222.25 PR** ⚠️

**Valve Covers Billet Specialties Ford Small Block**



- BIS95320**.....ALL  
Ball milled, polished. Tall. Fit 62-85 289, 302, 351W & 5.0L engines. 0.386 -0.15 ..... **\$150.00 PR** ⚠️

**Valve Covers Aluminum Ford Small Block**



- R6170**.....ALL  
Polished Alum SB Ford Tall Valve Cover - Plain without Hole & Baffled. -0.15 ..... **\$101.00 PR** ⚠️



- R6171**.....ALL  
Polished Alum SB Ford Tall Valve Cover - Plain with Hole & Baffled. -0.15 ..... **\$100.50 PR** ⚠️

**Valve Covers Aluminum Ford Small Block, cont.**

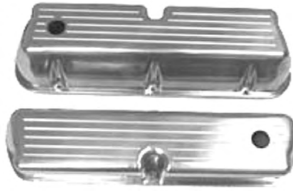

- R6172**.....ALL  
Polished Alum SB Ford Tall Valve Cover - Ballmilled with Hole & Baffled. -0.15 ..... **\$114.50 PR** ⚠️



- R6283**.....ALL  
Ford 289. Finned black aluminum, tall. -0.15 ..... **\$201.75 PR** ⚠️

**Valve Covers Steel Ford Small Block**

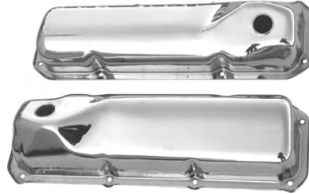

- R9295**.....ALL  
Chrome 1970-up Ford 351C-351M-400 Valve Cover - Baffled (Includes Grommets). -0.15 ..... **\$34.00 PR** ⚠️

**Valve Covers Steel Ford Big Block**

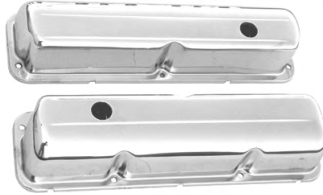

- R9296**.....ALL  
Chrome 1958-76 Ford 352-390-406-427-428 V8 Valve Cover - Baffled (Includes Grommets). -0.15 ..... **\$37.50 PR** ⚠️

**Valve Covers Olds**



- R9391**.....ALL  
Chrome 1964-88 Oldsmobile 330-455 V8 Short Valve Cover - Baffled (Includes Grommets). -0.15 ..... **\$34.00 PR** ⚠️

**Valve Covers Pontiac**



- R9300**.....ALL  
Chrome 1959-79 Pontiac 326-455 V8 Tall Valve Cover - Baffled (Includes Grommets). -0.15 ..... **\$32.00 PR** ⚠️



- R9461**.....ALL  
Chrome 1959-79 Pontiac 326-455 V8 Short Valve Cover - Unbaffled (Includes Grommets). -0.15 ..... **\$32.50 PR** ⚠️

**Valve Covers Steel Chrysler Big Block**



- R9299**.....ALL  
Chrome 1958-88 Chrysler 383-426-440 Wedge V8 Short Valve Cover - Baffled (Includes Grommets). -0.15 ..... **\$32.00 PR** ⚠️

**Valve Covers Aluminum Mopar**



\*Cap not included\*

- R6295**.....66-71  
Polished aluminum. Fits 66-71 street HEMI. -0.15 ..... **\$708.50 PR** ⚠️



- R6296**.....66-71  
Plain black aluminum. Fits 66-71 street HEMI. -0.15 ..... **\$426.00 PR** ⚠️

**Valve Covers Aluminum Mopar, cont.**

**R6346**.....**66-71**  
Fabricated Clear Anodized Aluminum. Fits 66-71 street HEMI. -.015 .. **\$310.00 PR** ⚠



\*Cap not included\*

**R6346C** .....**66-71**  
Fabricated Polished Aluminum. Fits 66-71 street HEMI. -.015 .... **\$310.00 PR** ⚠

**R6346POL** .....**66-71**  
Fabricated Polished Aluminum. Fits 66-71 street HEMI. -.015 .... **\$306.75 PR** ⚠

**Valve Covers Chevy Six Cylinder**



**3686784C** .....**37-53**  
Chrome 1937-53 Chevy 216 6-cyl Valve Cover - Unbaffled. -.015 . **\$46.75 EA** ⚠



**36867840** .....**37-53**  
Offenhauser Ribbed for 216ci. Polished aluminum valve cover. 0.386 -.015  
..... **CALL** ⚠



**3686784F** .....**37-62**  
Finned aluminum valve cover for 216 & 235. -0 ..... **\$279.00 EA** ⚠



**3686784FP** .....**37-62**  
Finned polished aluminum valve cover for 216 & 235. -0 ..... **\$389.00 EA** ⚠

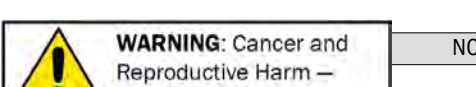

**Valve Covers Chevy Six Cylinder, cont.**



**3686784W**.....**37-62**  
"Wayne" Finned aluminum cover. Superb reproduction w/ breather cap and stud kit. 0.386 -0 ..... **CALL** ⚠



**38366140** .....**37-62**  
Offenhauser Ribbed for 235ci. Polished aluminum valve cover. 0.386 -.015  
..... **CALL** ⚠

**OTB-6413**..... **ALL**  
1/2" aluminum thermostat housing spacer. Used to space thermostat housing away from aftermarket valve covers. Includes mounting hardware. Fits 216ci, 235ci, 261ci -0 ..... **\$39.25 EA** ⚠

**Valve & Rocker Cover Set Chevy Six Cylinder**



**3836614S** .....**50-62**  
235ci chromed side cover & valve cover w/ breather cap and gaskets. Excellent finish. 0.386 -.015 ..... **\$116.00 SET** ⚠

**Side Covers Chevy Six Cylinder**



**3701541F** .....**50-62**  
Finned plain aluminum side cover. Fits 235ci-261ci. 0.439 -0 .. **\$219.00 EA** ⚠



**3701541FP** .....**50-62**  
Finned polished aluminum side cover. Fits 235ci-261ci. 0.439 -0 .. **\$299.00 EA** ⚠

**37015410F** ..... **50-62**  
Offenhauser Finned polished aluminum side cover. Fits 235ci-261ci. -0 ..... **\$290.00 EA** ⚠

**Side Covers Chevy Six Cylinder, cont.**



**3701541W**.....**50-62**  
"Wayne" Finned aluminum side cover. Superb reproduction, fits 235ci-261ci. 0.439 -0 ..... **CALL** ⚠



**R9108**.....**ALL**  
Chrome 1950-62 Chevy 235 6-cyl Side Plate. -.015 ..... **\$36.25 EA** ⚠

**Valve Cover Fasteners**



**R6010**.....**ALL**  
Red Aluminum T-Bar Wing Nut - 4 5/8" Tall with 1/4-20 x 1 1/4" Stud (Package of 4). -.015 ..... **\$11.25 EA** ⚠



**R6011**.....**ALL**  
Blue Aluminum T-Bar Wing Nut - 4 5/8" Tall with 1/4-20 x 1 1/4" Stud (Package of 4). -.015 ..... **\$11.25 EA** ⚠



**R6017**.....**ALL**  
Gold Aluminum T-Bar Wing Nut - 4 5/8" Tall with 1/4-20 x 1 1/4" Stud (Package of 4). -.015 ..... **\$11.25 EA** ⚠



**R6018**.....**ALL**  
Silver Aluminum T-Bar Wing Nut - 4 5/8" Tall with 1/4-20 x 1 1/4" Stud (Package of 4). -.015 ..... **\$11.25 EA** ⚠

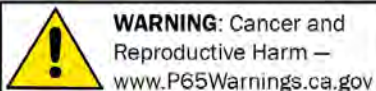

NOTE: Any chemicals will be shipped domestic ground only (Lower 48 states only). No international shipping.

**Valve Cover Fasteners**



**R9120**.....ALL  
 Chrome 4 1/4" T-Bar Wing Nut with  
 1/4-20 x 1 3/8" Stud (Package of 4). -0  
 ..... \$7.75 EA ⚠



**R9640**.....ALL  
 Chrome BB Chevy 396-454 Valve Cover  
 Spreader Bars (Set of 7). -0.15  
 ..... \$8.50 EA ⚠



**R9672**.....ALL  
 Chrome 5 3/8" T-Bar Wing Nut with  
 5/16-18 x 1 1/2" Stud (Package of  
 4). -0.15 ..... \$9.50 EA ⚠

**Valve Cover Hardware**



**838083B** .....37-62  
 Studs, washers & nuts for Wayne or Offy  
 valve cover 0.413 -0.15 ..... \$15.00 SET ⚠

**8380830TB** .....37-62  
 Studs, washers & acorn nuts for OTB valve  
 cover 0.413 -0 ..... \$39.25 SET ⚠

**Valve Cover Breathers Billet Specialties**



**BIS20120**.....ALL  
 Smooth, polished. Fits 1-1/4in hole.  
 0.386 -0.15 ..... \$31.75 EA ⚠

**Valve Cover Breathers Billet Specialties, cont.**

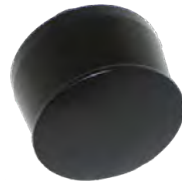

**BIS20120BLK** .....ALL  
 Smooth, black powdercoated. Fits 1-1/4in  
 hole. 0.386 -0 ..... \$36.29 EA ⚠



**BIS20220**.....ALL  
 Bowtie, polished. Fits 1-1/4in hole.  
 0.386 -0.15 ..... \$36.25 EA ⚠

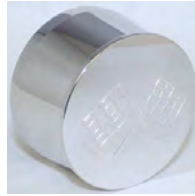

**BIS20720**.....ALL  
 Cross Flags, polished. Fits 1-1/4in hole.  
 0.386 -0 ..... \$35.39 EA ⚠



**BIS20820**.....ALL  
 Ball milled, polished. Fits 1-1/4in hole.  
 0.386 -0.15 ..... \$31.75 EA ⚠



**BIS20920**.....ALL  
 Ball milled, polished oval breather. Fits  
 1-1/4in hole. 0.386 -0 ..... \$35.39 EA ⚠



**BIS20929**.....ALL  
 Smooth, polished oval breather. Fits  
 1-1/4in hole. 0.386 -0 ..... \$35.39 EA ⚠

**Valve Cover Breathers Billet Specialties, cont.**



**BIS20950**.....ALL  
 Ribbed, polished oval breather. Fits  
 1-1/4in hole. 0.386 -0.15 ..... \$44.75 EA ⚠



**BIS21120**.....ALL  
 with PCV. 0.386 -0.15 ..... \$32.50 EA ⚠



**BIS21120BLK** .....ALL  
 with PCV. Black powdercoated. 0.386 -0.15  
 ..... \$41.00 EA ⚠



**BIS21220**.....ALL  
 Bowtie, polished. Fits 1-1/4in hole. 0.386 -0  
 ..... \$36.29 EA ⚠



**BIS21720**.....ALL  
 with PCV. Cross Flags. 1-1/4" hole. 0.386 -0  
 ..... \$36.29 EA ⚠



**BIS21820**.....ALL  
 with PCV. 0.386 -0.15 ..... \$32.50 EA ⚠

**Valve Cover Breathers Billet Specialties, cont.**



**BIS21920** .....ALL  
with PCV. 0.386 -0.15 ..... **\$37.25 EA** ⚠



**BIS21929** .....ALL  
with PCV. 0.386 -0 ..... **\$36.29 EA** ⚠



**BIS21950** .....ALL  
with PCV. 0.386 -0.15 ..... **\$45.75 EA** ⚠

**Valve Cover Breathers (Aluminum)**



**R6000C** .....ALL  
Chrome Aluminum PCV Push-In Breather  
- Plain with 1" Neck. -0.15 ..... **\$34.00 EA** ⚠



**R6000X** .....ALL  
Polished Aluminum PCV Push-In Breather  
- Flame with 1" Neck. -0.15 ..... **\$31.50 EA** ⚠

**Valve Cover Breathers (Aluminum), cont.**



**R6001XC** .....ALL  
Chrome Aluminum Push-In Breather  
- Flame with 1" Neck. -0.15 ..... **\$35.00 EA** ⚠



**R6008** .....ALL  
Polished Billet Aluminum PCV Valve with  
3/4" Neck. -0.15 ..... **\$26.25 EA** ⚠



**R6100** .....ALL  
Polished Aluminum Push-In Breather with  
PCV Tube - Ball Milled with 1" Neck. 3 line  
design. -0.15 ..... **\$30.75 EA** ⚠



**R6101** .....ALL  
Polished Aluminum Push-In Breather - Ball  
Milled with 1" Neck. 3 line design. -0.15  
..... **\$32.60 EA** ⚠



**R6101C** .....ALL  
Chrome Aluminum Push-In Breather - Ball  
Milled with 1" Neck. 3 line design. -0.15  
..... **\$34.00 EA** ⚠

**Valve Cover Breathers (Aluminum), cont.**



**R6201** .....ALL  
Polished Aluminum Push-in Enclosed Filter  
Breather - Ball Milled. -0.15 ..... **\$28.75 EA** ⚠



**R6505** .....ALL  
Polished Aluminum Oval Push-in Breather  
- Finned. -0.15 ..... **\$36.50 EA** ⚠

**Finned Valve Cover Breather**



**OTB-6810FP** .....37-62  
Finned Polished Aluminum 90 Degree  
Mount -0 ..... **\$89.00 EA** ⚠



**OTB-6811F** .....37-62  
Finned Aluminum 90 Degree Mount -0  
..... **\$72.00 EA** ⚠



**OTB-6801** .....ALL  
Finned polished aluminum. 1" dia. neck  
for 1-1/4" hole using a rubber  
grommet. -0.15 ..... **\$53.25 EA** ⚠

# Section 022: Valve Covers, Breathers, Engine Accessories

## Finned Valve Cover Breather, cont.



**OTB-6805** .....ALL  
 Finned polished aluminum. For use with  
 Offenhauser or Wayne valve covers -0.15  
 ..... \$48.25 EA ⚠

## Valve Cover Breathers



**R4803** .....ALL  
 Chrome Twist-On Breather Cap - 2 3/8"  
 Diameter. -0.15 ..... \$4.50 EA ⚠



**R4870** .....ALL  
 Chrome Push-In Breather Cap - 2 3/4"  
 Diameter. -0.15 ..... \$4.75 EA ⚠



**R7192** .....ALL  
 Chrome Push-In Filter Breather - Short  
 Style. -0.15 ..... \$11.00 EA ⚠



**R7410X** .....ALL  
 Rectangular Push-in Breather with PCV  
 Tube. -0.15 ..... \$3.25 EA ⚠

## Valve Cover Breathers, cont.



**R9171** .....ALL  
 Chrome Push-In PCV Breather Cap - 2  
 3/4" Diameter with 3/4" Neck. -0.15  
 ..... \$4.25 EA ⚠



**R9241** .....ALL  
 Chrome Push-In Breather with Tube - 2  
 3/4" Diameter. -0.15 ..... \$4.49 EA ⚠



**R9309** .....ALL  
 Chrome Clamp-On Filter Breather - 1 1/2"  
 Hole. -0.15 ..... \$10.00 EA ⚠

**R9309X** .....ALL  
 Chrome Clamp-On Filter Breather - 1 3/8"  
 Hole. -0.15 ..... \$10.00 EA ⚠

**R9517** .....ALL  
 Chrome Clamp-On Filter Breather with  
 Shield - 1 1/2" Hole. -0.15 .. \$13.50 EA  
 ⚠

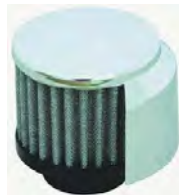

**R9517X** .....ALL  
 Chrome Clamp-On Filter Breather with  
 Shield - 1 3/8" Hole. -0.15 .. \$13.50 EA  
 ⚠



**R9617** .....ALL  
 Chrome Twist-On Breather Cap - 2 3/4"  
 Diameter. -0.15 ..... \$6.50 EA ⚠

## Valve Cover Breather Grommets NON PCV



**R4880** .....ALL  
 Push-In Breather Grommet - 1" ID x 1 1/4"  
 OD (Package of 2). -0.4 ..... \$27.00 PR ⚠

## Valve Cover Breather Grommets PCV



**R4997** .....ALL  
 Push-In or PCV Breather Grommet - 3/4"  
 ID x 1 1/4" OD (Package of 2). -0.15  
 ..... \$2.00 PR ⚠



**R4998X** .....ALL  
 PCV Breather Grommet for Aluminum  
 Valve Cover - 3/4" ID x 1 1/4" OD  
 (Package of 2). -0.15 ..... \$2.29 PR ⚠



**R9359** .....ALL  
 Rubber Push-in PCV Grommet for Steel  
 Valve Cover 3/4" ID x 1 1/4" OD (Package  
 of 2). -0.15 ..... \$1.89 PR ⚠



**R9760** .....ALL  
 Rubber Ford PCV Grommet - 3/4" ID x 1"  
 OD (Package of 2). -0.15 ..... \$2.00 PR ⚠

**Valve Cover Oil Caps**



**OTB-6152FP** .....37-62  
 Finned Polished Aluminum Oil Cap 2-5/8"  
 Dia 1" Tall -0 ..... **\$34.00 EA** ⚠



**OTB-6153F** .....37-62  
 Finned Aluminum Oil Cap 2-5/8" Dia 1"  
 Tall -0 ..... **\$26.00 EA** ⚠

**6150SP** ..... ALL  
 Valve cover Sprocket Polished Oil Cap  
 Polished Diameter - 3". Height - 1-1/8". -0  
 ..... **\$43.00 EA** ⚠

**6151S** ..... ALL  
 Valve cover Sprocket Unpolished Oil Cap  
 Polished Diameter - 3". Height - 1-1/8". -0  
 ..... **\$31.00 EA** ⚠



**836450** ..... ALL  
 Chrome, fits aluminum valve cover  
 (breather cap). 1.516 -0.15 ..... **\$15.89 EA**  
 ⚠



**R4804** ..... ALL  
 Chrome GM Twist-In Style Oil Filler  
 Cap. -0.15 ..... **\$3.75 EA** ⚠



**R6050** ..... ALL  
 Polished Aluminum Push-In Oil Cap - Plain  
 with 1" Neck. -0.15 ..... **\$14.00 EA** ⚠

**Valve Cover Oil Caps, cont.**



**R9373** ..... ALL  
 Rubber Oil Plug with "Oil" Logo. -0.15  
 ..... **\$2.00 EA** ⚠



**R9787** ..... ALL  
 Chrome Push-In Oil Cap with "Oil"  
 Logo. -0.15 ..... **\$3.59 EA** ⚠

**Oil Pans Chevy Small Block**

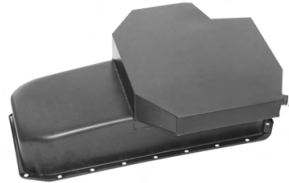

**R7101P** ..... ALL  
 Black 1955-79 SB Chevy Champion Style  
 Oil Pan - Driver Side Dipstick (7 qts). -0.15  
 ..... **\$115.00 EA** ⚠



**R7101R** ..... ALL  
 Unplated 1955-79 SB Chevy 283-350  
 Champion Style Oil Pan - Driver Side  
 Dipstick (7 qts). -0.15 ..... **\$102.25 EA** ⚠

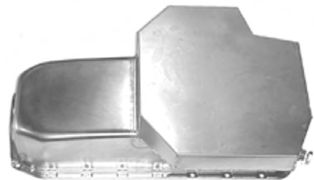

**R7101Z** ..... ALL  
 Zinc 1955-79 SB Chevy 283-350  
 Champion Style Oil Pan - Driver Side  
 Dipstick (7 qts). -0.15 ..... **\$114.50 EA** ⚠

**Oil Pans Chevy Small Block, cont.**



**R7108P** ..... ALL  
 Black Pre-1980 SB Chevy 283-350  
 Claimer Oil Pan - Driver Side Dipstick (4  
 qts). -0.15 ..... **\$86.75 EA** ⚠

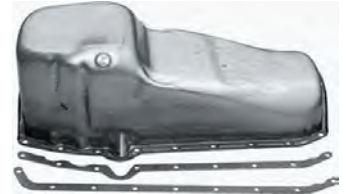

**R7108R** ..... ALL  
 Unplated Pre-1980 SB Chevy 283-350  
 Claimer Oil Pan - Driver Side Dipstick (4  
 qts). -0.15 ..... **\$68.25 EA** ⚠



**R7108Z** ..... ALL  
 Zinc Pre-1980 SB Chevy 283-350 Claimer  
 Oil Pan - Driver Side Dipstick (4 qts). -0.15  
 ..... **\$79.50 EA** ⚠

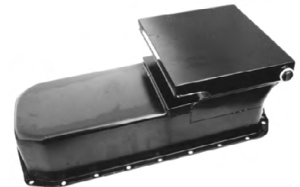

**R7480P** ..... ALL  
 Black 1962-67 Chevy 283-350 Rear Sump  
 Oil Pan (6 qts). -0.15 ..... **\$102.75 EA** ⚠



**R7480R** ..... ALL  
 Unplated 1962-67 Chevy 283-350 Rear  
 Sump Oil Pan (6 qts). -0.15  
 ..... **\$93.00 EA** ⚠



**WARNING: Cancer and Reproductive Harm** —  
[www.P65Warnings.ca.gov](http://www.P65Warnings.ca.gov)

NOTE: Any chemicals will be shipped domestic ground only (Lower 48 states only). No international shipping.

**(800) 952-1752 • www.streetrodhq.com**



# Section 022: Valve Covers, Breathers, Engine Accessories

## Oil Pans Chevy Small Block, cont.

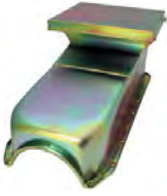

**R7480Z**.....ALL  
Zinc 1962-67 Chevy 283-350 Rear Sump  
Oil Pan (6 qts). -.15 . \$105.25 EA ⚠



**R8442**.....ALL  
Polished Aluminum 1955-79 SB Chevy Oil  
Pan (Dipstick on Driver's Side). 4 Qt -.15  
..... \$120.00 EA ⚠



**R8443**.....ALL  
Polished Aluminum 1980-85 SB Chevy Oil  
Pan (Dipstick on Passenger Side). 4  
Qt -.15 ..... \$98.00 EA ⚠



**R8444**.....ALL  
Polished Aluminum 1986-up SB Chevy Oil  
Pan (Dipstick on Passenger Side). 4  
Qt -.15 ..... \$98.00 EA ⚠



**R9005P**.....ALL  
Orange 1955-79 SB Chevy  
283,305,327,350,400 V8 Oil Pan - Driver  
Side Dipstick. 4 Qt -.15 .. \$49.00 EA  
⚠

## Oil Pans Chevy Small Block, cont.



**R9005R**.....ALL  
Unplated 1955-79 SB Chevy  
283,305,327,350,400 V8 Oil Pan - Driver  
Side Dipstick. 4 Qt. -.15 . \$40.69 EA  
⚠



**R9414**.....ALL  
Chrome 1986-up SB Chevy  
283,305,327,350,400 Oil Pan -  
Passenger Side Dipstick. 4 Qt -.15  
..... \$68.50 EA ⚠



**R9414P**.....ALL  
Black 1986-up SB Chevy  
283,305,327,350,400 Oil Pan -  
Passenger Side Dipstick. 4 Qt -.15  
..... \$56.50 EA ⚠



**R9414R**.....ALL  
Unplated 1986-up SB Chevy  
283,305,327,350,400 Oil Pan -  
Passenger Side Dipstick. 4 Qt. -.15  
..... \$43.25 EA ⚠

## Oil Pan Chevy Big Block



**R9294P**.....ALL  
Black 1965-90 BB Chevy 396-402-427-  
454 Oil Pan. -.15 ..... \$60.00 EA ⚠

## Oil Pans Ford Small Block



**R9078P**.....65-87  
Blue 1965-87 Ford 260-289-302 V8 Front  
Sump Oil Pan. Cars only -.15  
..... \$66.00 EA ⚠



**R9078R**.....65-87  
Unplated 1965-87 Ford 260-289-302 V8  
Front Sump Oil Pan. Cars only -.15  
..... \$43.25 EA ⚠



**R9310**.....70-80  
Chrome 1970-80 Ford 351C-351 M-400  
V8 Front Sump Oil Pan. Cars only -.15  
..... \$75.00 EA ⚠



**R9310R**.....ALL  
Unplated 1970-80 Ford 351C-351M-400  
V8 Front Sump Oil Pan. Cars only -.15  
..... \$63.50 EA ⚠

**R9532R**.....ALL  
Unplated 1967-87 Ford 351W V8 Front  
Sump Oil Pan. -.15 ... \$52.25 EA ⚠

## Oil Pans Ford Big Block



**R9330**.....58-76  
Chrome 1958-76 Ford 352-390-406-427-  
428 V8 Front Sump Oil Pan. Cars only -.15  
..... \$71.25 EA ⚠

Returns require a return authorization number—Please call first. · Note: Product pricing and availability subject to change.

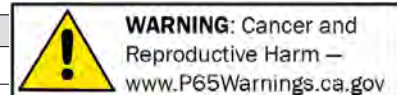

**Oil Pans Ford Big Block, cont.**



**R9343** ..... **68-78**  
 Chrome 1968-78 Ford 429-460 V8 Front  
 Sump Oil Pan. cars only -0.15

..... **\$75.00 EA** ⚠

**R9330R** ..... **ALL**  
 Unplated 1958-76 Ford 352-390-406-  
 427-428 V8 Front Sump Oil Pan. Cars  
 only -0.15

..... **\$52.25 EA** ⚠

**Oil Pans Mopar**



**R9344** ..... **71-80**  
 Chrome Steel 1971-80 Mopar 360 Oil Pan.  
 Cars only - center sump pan -0.15

..... **\$79.50 EA** ⚠



**R7117P** ..... **ALL**  
 Black BB 1966-up Chrysler Mopar 361-  
 440 B & RB & Hemi 426 Deep Sump Oil  
 Pan (7 qts). -0.15

..... **\$105.25 EA** ⚠



**R7117R** ..... **ALL**  
 Unplated 1966-up Chrysler BB 361-440 &  
 Hemi 426 Deep Sump Oil Pan (7  
 qts). -0.15

..... **\$95.25 EA** ⚠

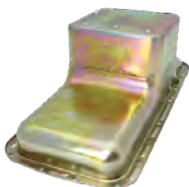

**R7117Z** ..... **ALL**  
 Zinc 1966-up Chrysler BB 361-440 &  
 Hemi 426 Deep 7" Sump Oil Pan (7  
 qts). -0.15

..... **\$107.50 EA** ⚠

**Oil Pans Mopar, cont.**



**R9311R** ..... **ALL**  
 Unplated 1964-87 Chrysler Mopar  
 273-318-340 V8 Oil Pan. Front sump -0.15

..... **\$55.75 EA** ⚠



**R9496** ..... **ALL**  
 Chrysler, Mopar 361-383-400-413-440 B  
 & RB and Hemi 426 Stock capacity -0.15

..... **\$70.25 EA** ⚠



**R9496R** ..... **ALL**  
 Unplated Chrysler 361-383-400-413-440  
 B & RB And Hemi. Stock capacity  
 -0.15

..... **\$56.75 EA** ⚠

**Oil Pans Olds & Pontiac**

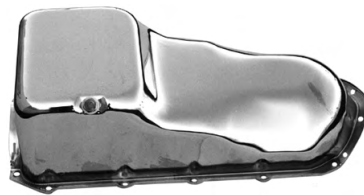

**R9337** ..... **ALL**  
 Chrome 1974-81 Pontiac 301-326-350-  
 389-400-421-425-455 Oil Pan. -0.15

..... **\$81.75 EA** ⚠

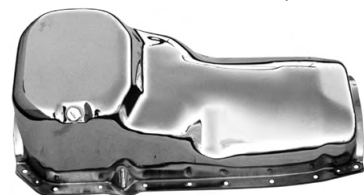

**R9397** ..... **ALL**  
 Chrome Oldsmobile 330-350-400-425-  
 455 Oil Pan. Stock capacity -0.15

..... **\$86.50 EA** ⚠

**R9397R** ..... **ALL**  
 Unplated Oldsmobile 330-350-400-425-  
 455 Oil Pan. Stock capacity -0.15

..... **\$70.00 EA** ⚠

**Oil Pan Drain Plug**



**R9062** ..... **ALL**  
 Chrome Magnetic  
 Plug with Plastic  
 Washer (1/2"-  
 20). -0.15

..... **\$2.25 EA** ⚠

**Oil Pump Pickup**



**R7102** ..... **ALL**  
 Zinc Oil Pump Pickup For R7101 - 4 Bolt  
 Pump. -0.15

..... **\$12.50 EA** ⚠



**R7103** ..... **ALL**  
 Zinc Oil Pump Pickup For R7101 - 5 Bolt  
 Pump. -0.15

..... **\$11.50 EA** ⚠



**R7110** ..... **ALL**  
 Zinc Hi-Volume Oil Pump Pickup for  
 R7108. -0.15

..... **\$14.00 EA** ⚠



**R7118** ..... **ALL**  
 Stock "B" & "RB" Pumps Oil Pickup for  
 R7117 (3/8-18 thread). -0.15

..... **\$21.00 EA** ⚠

**R7119** ..... **ALL**  
 Stock "Hemi" Pumps Oil Pickup for R7117  
 (1/2-14 thread). -0.15

..... **\$21.00 EA** ⚠



**WARNING: Cancer and  
 Reproductive Harm —  
 www.P65Warnings.ca.gov**

NOTE: Any chemicals will be shipped domestic ground only (Lower 48 states only). No international shipping.

**(800) 952-1752 • www.streetrodhq.com**

**Engine Dipsticks Billet Specialties Chevy**



**BIS40120 . . . . .ALL**  
 These dipsticks not only look great but are truly functional. By eliminating the stock dipstick tube and using an O-ring seal, leakage and blow-by are

effectively eliminated. Designed to fit Small Block Chevys (up to 1979) with drivers side tube. 1.516 -0

..... **\$21.50 EA** ⚠

**Engine Dipsticks Machined Lokar Chevy**

Flexible engine dipstick designed w/ machined aluminum hole to coordinate w/ Lokar's Flexible Transmission Dipstick. Slim design allows mounting inside headers. E-Z read stainless stick for accurate measure of engine oil.



**ED-5000ESB . . . . .ALL**  
 Lokar Machined aluminum & stainless dipstick for pre-1980 small block Chevy. Application is

straight into the engine block-no tube necessary. Dipstick seals at bottom of hole w/ o-ring. Machined aluminum hole designed to coordinate w/ Lokar transmission dipstick. 1.516 -0.15

..... **\$36.95 EA** ⚠



**ED-5001. . . . .ALL**  
 Lokar Flexible Chevy small block 1980 & later. Designed for use w/ factory or Sanderson

cast manifold. (Dipstick mounts on the passenger's side.). 1.516 -0.15

..... **\$72.00 EA** ⚠



**ED-5002. . . . .ALL**  
 Lokar Flexible. Fits Chevy small block, 1979 & earlier. Designed for use w/ factory or Sanderson

cast manifold. (Dipstick mounts on the driver's side.). 1.516 -0.15

..... **\$76.75 EA** ⚠

**Engine Dipsticks Machined Lokar Chevy, cont.**

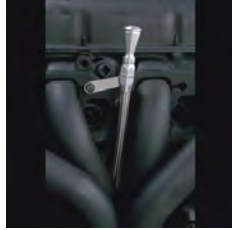

**ED-5003. . . . .ALL**  
 Lokar Flexible Chevy big block, designed for clearance w/ block hugger headers. 1.516 -0.15

..... **\$72.00 EA** ⚠



**ED-5006. . . . .ALL**  
 Lokar Flexible Chevy 502 big block, designed for clearance w/ block hugger headers.

1.516 -0.15

..... **\$72.00 EA** ⚠



**ED-5009. . . . .ALL**  
 Lokar Flexible, GM Vortec Ramjet 350. Designed for use w/ factory or Sanderson cast manifold. -0.15

..... **\$72.00 EA** ⚠

**Engine Dipsticks Chevy**



**R4957. . . . .ALL**  
 Chrome 1955-79 SB Chevy 283-350 Engine Dipstick and Tube. -0.15

..... **\$5.49 EA** ⚠



**R4957BA . . . . .ALL**  
 Billet Aluminum Handle 1955-79 SB Chevy 283-350 Engine Dipstick. -0.15

..... **\$12.19 EA** ⚠



**R4958BA . . . . .ALL**  
 Billet Aluminum Handle 1965-90 BB Chevy 396-454 Engine Dipstick. -0.15

..... **\$12.50 EA** ⚠



**R5001. . . . .ALL**  
 Polished Aluminum Braided, 1980-up SB Chevy Flexible Engine Dipstick. -0.15  
**\$39.50 EA** ⚠

**Engine Dipsticks Chevy, cont.**



**R5003. . . . .ALL**  
 Polished Aluminum Braided, BB Chevy Flexible Engine Dipstick. -0.15  
 ..... **\$35.49 EA** ⚠



**R9420BA . . . . .ALL**  
 Billet Aluminum Handle 1980-82 SB Chevy 305-350 Engine Dipstick. -0.15  
 ..... **\$12.75 EA** ⚠

**Engine Dipsticks Billet Specialties Ford**



**BIS40150. . . . .ALL**  
 Billet Specialties, Ford SB. Designed for use with the Tru Trac billet timing cover only. Features easy to read level markings and stainless steel braided cover with Teflon inner tube. For use with front sump oil pans only. -0  
 ..... **\$63.00 EA** ⚠

**Engine Dipsticks Machined (Lokar) Ford**



**ED-5005 . . . . .ALL**  
 Lokar, 351 Windsor. Screws into pan. -0.15  
 ..... **\$74.39 EA** ⚠

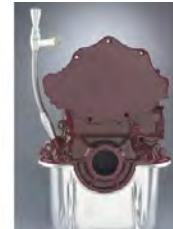

**ED-5010. . . . .ALL**  
 289 & 302 Early style, Lokar. -0.15

..... **\$72.00 EA** ⚠

**Engine Dipsticks Machined (Lokar) Ford, cont.**



**ED-5011** .....ALL  
Lokar, For 460 & 514 Ford Big Block crate engines only. -0.15 ..... **\$72.00 EA** ⚠



**ED-5012** .....ALL  
Billet aluminum Lokar oil dipstick, FE Ford block. -0.15 ..... **\$72.00 EA** ⚠

**ED-5013** .....ALL  
Lokar, Early 302. -0.15 .. **\$76.75 EA** ⚠

**Engine Dipsticks Ford**



**R9221** .....ALL  
Chrome SB Ford 260-289-302 Engine Dipstick and Tube. -0.15 ..... **\$6.75 EA** ⚠



**R9221BA** .....ALL  
Billet Aluminum Handle SB Ford 260-289-302 Engine Dipstick. -0.15 ..... **\$12.00 EA** ⚠



**R9223** .....ALL  
Chrome Ford 351 Cleveland Engine Dipstick. -0.15 ..... **\$7.50 EA** ⚠

**Engine Dipsticks Mopar**



**R9224** .....ALL  
Chrome Chrysler 318-340-360 Engine Dipstick. -0.15 ..... **\$6.75 EA** ⚠



**R9225** .....ALL  
Chrome Chrysler 383-426-440 Engine Dipstick. -0.15 ..... **\$6.75 EA** ⚠

**Engine Dipsticks Mopar, cont.**



**R9225BA** .....ALL  
Billet Aluminum Handle Chrysler 383-426-440 Engine Dipstick. -0.15 ..... **\$12.00 EA** ⚠

**Engine Dipsticks Pontiac**



**R9405** .....ALL  
Chrome 1965-79 Pontiac V8 Engine Dipstick. -0.15 ..... **\$6.75 EA** ⚠



**R9405BA** .....ALL  
Billet Aluminum Handle 1965-79 Pontiac V8 Engine Dipstick. -0.15 ..... **\$13.00 EA** ⚠

**Timing Gear Set Chevy**



**R8412** .....ALL  
Steel BB Chevy High Performance Gear Drive. -0.15 ..... **\$144.75 EA** ⚠

**Timing Tab Steel**



**R4960** .....ALL  
Chrome SB Chevy 283-350 Timing Tab with 6"-7"-8" Balancer. -0.15 ..... **\$2.00 EA** ⚠



**R4961** .....ALL  
Chrome BB Chevy 396-454 Timing Tab with 8" Balancer. -0.15 ... **\$1.99 EA** ⚠

**Timing Tab Steel, cont.**



**R9178** .....ALL  
Chrome SB Chevy 283-350 Timing Tab with 7" Pointer. -0.15 ..... **\$2.50 EA** ⚠



**R9179** .....ALL  
Chrome SB Chevy 283-350 Timing Tab with 8" Pointer. -0.15 ..... **\$2.76 EA** ⚠

**R9180** .....ALL  
Chrome BB Chevy 396-454 Timing Tab with 8" Pointer. -0.15 ..... **\$2.59 EA** ⚠

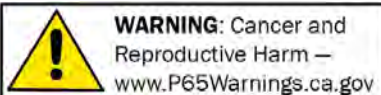

NOTE: Any chemicals will be shipped domestic ground only (Lower 48 states only). No international shipping.

## Section 026: Motor Mounts

Note: Transmission Mounts & Conversion kits see Section 150

### Crossmember (Bolt On) Chevy Truck



**3716772**.....**47-54**  
Motor mount crossmember will work for 40-46 truck if cut 1" from each end.  
0.029-0.15 ..... **\$68.00 EA** ⚠

### Engine Mount Kits Chevy Cars

These mounting kits are for '58 & up Chevy V8s into 37-54 Chevy cars. Kits include Bolt-on frame adapters, engine side mounts, thru-bolt cushion set, bolts and instructions. No firewall mods needed.



**CP-1100**.....**37-39**  
37-39 Chevy Car. Fits Pinto/ Mustang II IFS conversions (won't fit '39 Deluxe or cars w/ cross steering). ('58 & up SB).  
0.029-0 ..... **\$165.00 SET** ⚠



**CP-1102**.....**37-39**  
Engine Mounting Kit, 1939 Chevy Deluxe & 1937-39 cars with cross steering. This Kit Includes: Bolt on frame adapters Chassis Engineering engine side mounts- Includes offset mounts on the left side needed for clearance Cushion set Hardware Instructions Engine mounts fit: Chevy V8, 1958-up : 283, 302, 307, 327, 350 0.029-0 ..... **\$175.00 SET** ⚠



**3659291M**.....**37-48**  
Bolt-in, for Chev V8 into 37-48 Chev Car  
0.027-0.15 ..... **\$108.00 PR** ⚠

### Engine Mount Kits Chevy Cars, cont.



**3693425N**.....**37-54**  
Weld-in, for Chev V8 into 37-54 Chev Car  
0.027-0.2 ..... **\$65.75 PR** ⚠

**CP-1106**.....**40**  
1940 Chevy Car. Straight axle front ends only. ('58 & up SB). 0.029-0  
..... **\$165.00 SET** ⚠

**CP-1106A**.....**40**  
1940 Chevy Car. Knee action shock front ends only. ('58 & up SB). 0.029-0  
..... **\$165.00 SET** ⚠

**CP-1106G**.....**40**  
For NON-Chassis Engineering IFS kits. ('58 & up SB). 0.029-0 ..... **\$165.00 SET** ⚠

**CP-1106GB**.....**40**  
1940 Chevy Car. For Chassis Engineering Must II/ Pinto IFS kits. ('58 & up SB).  
0.029-0 ..... **\$165.00 SET** ⚠



**CP-1107**.....**41-48**  
Stock knee action shock front ends only. ('58 & up SB). 0.029-0 ..... **\$165.00 SET** ⚠



**CP-1107G**.....**41-48**  
For Chassis Engineering or Must II/ Pinto IFS kits. ('58 & up SB). 0.029-0  
..... **\$208.75 SET** ⚠



**CP-1109**.....**49-54**  
For cars w/ stock suspension. ('58 & up SB). 0.029-0 ..... **\$168.75 SET** ⚠

### Engine Mount Kits Chevy Cars, cont.

**CP-1109PM**.....**49-54**  
For NON-Chassis Engineering IFS kits. ('58 & up SB). 0.029-0 ..... **\$165.00 SET** ⚠

### Engine Mount Kits Chevy Trucks



**CP-1160**.....**40-54**  
1940-54 Chevy or GMC 1/2Ton truck. Fits stock suspension. Includes bolt on frame adapters (can be welded on), Chassis Engineering engine mounts, thru-bolt cushion set, bolts and instructions. Easy to install. 0.029-0 ..... **\$145.00 SET** ⚠



**CP-1160G**.....**40-54**  
1940-54 Chevy or GMC 1/2Ton truck. Fits Chassis Engineering & Mustang II/ Pinto IFS kits. Includes weld on frame adapters, c.e. engine mounts, thru bolt cushion set, bolts and instructions. 0.029-0  
..... **\$142.50 SET** ⚠

### Engine Mount Kits Ford Cars w/ Ford Small Block

Fits Ford small block into 41-48 Ford cars. Kits include frame adapters, engine side mounts, thru bolt cushion set, bolts and instructions for easy installation.



**CP-2202**.....**41-48**  
Bolt-on for solid axle cars. -0  
..... **\$165.00 SET** ⚠

**CP-2202G**.....**41-48**  
Weld-on for non-Chassis Engineering Mustang II IFS. -0 ..... **\$165.00 SET** ⚠

**CP-2212G**.....**41-48**  
Bolt-on for Chassis Engineering Mustang II IFS kit. -0 ..... **\$165.00 SET** ⚠

Returns require a return authorization number—Please call first. · Note: Product pricing and availability subject to change.

**Engine Mount Kits Ford/Merc Cars w/ GM Small Block**



**CP-2125** .....39-40  
Bolt-on for solid axle cars. -0  
..... **\$165.00 EA** ⚠



**CP-2102** .....41-48  
Bolt-on for solid axle cars. -0  
..... **\$165.00 SET** ⚠



**CP-2102G** .....41-48  
Bolt-on for Chassis Engineering Mustang II IFS kit. -0  
..... **\$143.00 SET** ⚠



**CP-2126** .....41-48  
Bolt-on with cross steering (stock of C.E. adapter). -0  
..... **\$165.00 EA** ⚠

**CP-2127** .....41-48  
Bolt-on for independent front ends. -0  
..... **\$165.00 EA** ⚠

**Frame Adapters Chevy V8 Transplants**



**3700332** .....49-54  
Motor mount & bracket, bolt-on. Fits Chev V8 into 49-54 Chev car 0.027 -0.15  
..... **\$139.25 PR** ⚠

**Frame Adapters Chevy V8 Transplants, cont.**



**3700332R** .....ALL  
Replacement for part # 3700332. Will not work with chassis engineering mounts. 0.027 -0.15  
..... **\$32.75 PR** ⚠

**Motor Mounts Chevy V8 (Use w/ V8 Brackets)**



**3988989** .....37-54  
Has anti-torque lock (w/ headers use #3988989B). 0.027 -0.15  
..... **\$7.75 EA** ⚠



**3988989B** .....37-54  
w/ headers. 0.027 -0.2  
..... **\$8.75 EA** ⚠



**3988989S** .....ALL  
Steel (no rubber cushion). Replaces stock rubber mounts, eliminates torque loss and linkage binding. 0.027 -0.15  
..... **\$44.49 PR** ⚠



**LSXMOUNT** .....ALL  
Use to mount LS1, LS6 or Vortec (4.8L, 5.3L or 6.0L) into cars setup for small block Chevy. 0.027 -0  
..... **\$72.00 PR** ⚠

**Motor Mounts Chevy V8 (Use w/ V8 Brackets), cont.**



**LSXMOUNT1** .....ALL  
Use to mount LS1, LS6 or Vortec (4.8L, 5.3L or 6.0L) into cars setup for small block Chevy.

Sets engine back 1" from standard SBC location. 0.027 -0.15  
..... **\$88.50 PR** ⚠

**Engine Mount Kit Chevy Trucks**



**CP-1160P** .....40-54  
Fits Chassis Engineering & Mustang II/ Pinto IFS kits. 0.029 -0  
..... **\$108.00 SET** ⚠

**Engine Mount Kits Ford Trucks**



**CP-2250** .....48-52  
Fits Ford SB for original suspension. -0  
..... **\$165.00 SET** ⚠

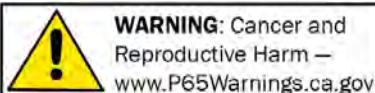

**WARNING: Cancer and Reproductive Harm** —  
www.P65Warnings.ca.gov

NOTE: Any chemicals will be shipped domestic ground only (Lower 48 states only). No international shipping.

Oversize shipping charges apply on radiators. Please call for rate.

**Trans Coolers**

For additional in-line trans coolers refer to Section 150 -Transmissions.

**Radiator (Aluminum) Custom**

To order a custom aluminum radiator for your specific application, please fill in and fax or mail the 2 page form found on our website and at the back of this catalog.



**PRC-CUSTOM** ..... 37-64  
Aluminum radiator for custom build quotes only. Designed to your specifications. Vertical or cross flow available. -.15  
..... starting at **\$512.50 EA** ⚠

**Radiator (Aluminum) Chevy Car**

These aluminum radiators offer great value at an unbeatable price. Includes billet necks for durability & weld-on mounting tabs. Upgrades for these radiators include: Electric Fan, Shroud and Full Polishing. Applications listed are vehicle specific. For custom applications, call or download our custom radiator order form.



**ALUMRAD** ..... 37  
Billet fill neck, rear mount. 1.219 -0.15  
..... **\$494.50 EA** ⚠  
**ALUMRADT** ..... 37  
Rear mount fill neck w/ internal trans cooler. 1.219 -0.15 ..... **\$566.50 EA** ⚠  
**ALUMRAD** ..... 38-39  
Top mount fill neck, offset. 1.219 -0.15  
..... **\$494.50 EA** ⚠  
**ALUMRADT** ..... 38-39  
Top mount fill neck, offset w/ internal trans cooler. 1.219 -0.15 ..... **\$580.25 EA** ⚠  
**ALUMRAD** ..... 40-41  
Top mount fill neck, offset. 1.219 -0.15  
..... **\$494.50 EA** ⚠  
**ALUMRADT** ..... 40-41  
Top mount fill neck, offset w/ internal trans cooler. 1.219 -0.15 ..... **\$566.49 EA** ⚠  
**ALUMRAD** ..... 42-48  
Top mount fill neck, offset. Size 19 3/4"W X 24"H. 1.219 -0.15 ..... **\$494.50 EA** ⚠

**Radiator (Aluminum) Chevy Car, cont.**

**ALUMRADT** ..... 42-48  
Top mount fill neck, offset w/ internal trans cooler. Size 19 3/4"W X 24"H. 1.219 -0.15 ..... **\$566.50 EA** ⚠  
**ALUMRAD** ..... 49-54  
Top mount fill neck, offset. Size: 23"H X 22"W. 1.219 -0.15 ..... **\$495.00 EA** ⚠  
**ALUMRADT** ..... 49-54  
With internal trans cooler. 12" without overdrive trans, 20" with overdrive trans. 1.219 -0.15 ..... **\$565.00 EA** ⚠  
**ALUMRAD** ..... 55-57  
Tri 5 Radiator & Core Support Assembly W/Out Trans Cooler -.15 .. **\$713.00 EA** ⚠

**Radiator (Aluminum) Chevy Truck**

**ALUMRAD** ..... 37-53  
Chevy Type 1 size: 18"W x 27"H. 1.219 -0.15 ..... **\$494.50 EA** ⚠  
**ALUMRADT** ..... 37-53  
Chevy Type 1 - 18"Wx27"H W/ internal transmission cooler. 1.219 -0.15  
..... **\$566.50 EA** ⚠  
**ALUMRAD** ..... 46-54  
Chevy Type 2 size: 20-1/4"W x 24-1/2"H. 1.219 -0.15 ..... **\$494.39 EA** ⚠  
**ALUMRADT** ..... 46-54  
Chevy Type 2 - 20 1/4"Wx24 1/2"H W/ internal transmission cooler. 1.219 -0.15  
..... **\$566.50 EA** ⚠

**Radiator (Aluminum) GMC Truck**

**ALUMRADG** ..... 37-54  
GMC Rear mount. Size: 18"W x 27"H. 1.219 -0.15 ..... **\$494.50 EA** ⚠  
**ALUMRADGT** ..... 37-54  
GMC Rear mount. Size: 18"W x 27"H. w/ internal trans cooler. 1.219 -0.15  
..... **\$565.00 EA** ⚠

**Radiator (Aluminum) Ford Car**

**ALUMRADFC** ..... 37-38  
Top mount fill neck. Size: 16-1/2" x 27". -.15 ..... **\$595.00 EA** ⚠  
**ALUMRADFC-T** ..... 37-38  
Top mount fill neck. Size: 16-1/2" x 27". With internal trans cooler. -.15  
..... **\$565.00 EA** ⚠  
**ALUMRADFC** ..... 39  
Rear mount fill neck, offset. -.15  
..... **\$495.00 EA** ⚠  
**ALUMRADFC-D** ..... 39  
Top mount fill neck. -.15 .. **\$495.00 EA** ⚠  
**ALUMRADFC-D-T** ..... 39  
Top mount fill neck w/ internal trans cooler. -.15 ..... **\$565.00 EA** ⚠  
**ALUMRADFT** ..... 39  
Size: 18 1/2"W X 28"H. -.15  
..... **\$565.00 EA** ⚠

**Radiator (Aluminum) Ford Car, cont.**

**ALUMRADFC** ..... 40  
Top mount fill neck. -.15 .. **\$495.00 EA** ⚠  
**ALUMRADFC** ..... 40  
Top mount fill neck. -.15 .. **\$495.00 EA** ⚠  
**ALUMRADFC-T** ..... 40  
Top mount fill neck w/ internal trans cooler. -.15 ..... **\$565.00 EA** ⚠  
**ALUMRADFC-T** ..... 41  
Top mount fill neck w/ internal trans cooler. -.15 ..... **\$565.00 EA** ⚠  
**ALUMRADFC** ..... 42-48  
Top mount fill neck. -.15 .. **\$495.00 EA** ⚠  
**ALUMRADFC-T** ..... 42-48  
Top mount fill neck w/ internal trans cooler. -.15 ..... **\$565.00 EA** ⚠  
**ALUMRADFC** ..... 52-56  
Top mount fill neck. -.15 .. **\$495.00 EA** ⚠  
**ALUMRADFC-T** ..... 52-56  
Top mount fill neck w/ internal trans cooler. -.15 ..... **\$565.00 EA** ⚠  
**Radiator (Aluminum) Ford Truck**  
**ALUMRADFT** ..... 37  
Rear mount fill neck offset. -.15  
..... **\$495.00 EA** ⚠  
**ALUMRADFT** ..... 38  
Rear mount fill neck, offset -.15  
..... **\$495.00 EA** ⚠  
**ALUMRADFT-T** ..... 38  
w/ internal trans cooler. -.15  
..... **\$565.00 EA** ⚠  
**ALUMRADFT-T** ..... 39  
w/ internal trans cooler. -.15  
..... **\$565.00 EA** ⚠  
**ALUMRADFT** ..... 42-52  
Top mount fill neck. -.15 .. **\$495.00 EA** ⚠  
**ALUMRADFT-T** ..... 42-52  
Top mount fill neck w/ internal trans cooler. -.15 ..... **\$565.00 EA** ⚠

**Radiator (ALUMRAD) Upgrades**



**ALUMRADACCON** ..... ALL  
Add an AC Condenser 1.219 -0.15  
..... **\$99.75 EA** ⚠

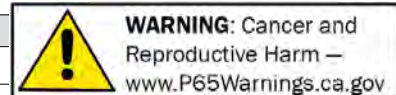

**Radiator (ALUMRAD) Upgrades, cont.**



**ALUMRADACMOUNT** .....ALL  
Mount AC condenser to radiator 1.219 -0.15  
..... \$40.00 EA ⚠



**ALUMRADFAN** .....ALL  
Electric fan for aluminum radiators. 16",  
2360CFM. Straight fan blades. 1.219 -0.15  
..... \$150.25 EA ⚠

**ALUMRADFANCOVER** .....ALL  
Polished aluminum fan cover for electric  
fan. 1.219 -0.15 ..... \$60.19 EA ⚠

**ALUMRADFANMOUNT** .....ALL  
Mount Fan to radiator 1.219 -0.15  
..... \$40.00 EA ⚠

**ALUMRADFANWIRE** .....ALL  
Single Fan Wiring Harness 1.219 -0  
..... \$56.00 EA ⚠

**ALUMRADSHROUD** .....ALL  
Aluminum fan shroud for radiators listed  
above. 1.219 -0.15 ..... \$99.75 EA ⚠

**POLISHRAD** ..... ALL  
Upgrade your radiator to a fully polished.  
1.219 -0 ..... \$125.00 EA ⚠

**POLISHSHROUD** .....ALL  
Upgrade fan shroud to polished 1.219 -0.15  
..... \$40.00 EA ⚠

**Radiator V8 (Aluminum)**

These radiators are high efficiency all aluminum, dual large core with transmission coolers. Radiators are built with dual 1-1/8" high flow tubes, double the capacity of stock 2-row. 33% more capacity than 3 row 1/2" tubes. Radiators used stamped aluminum tanks for a stock like appearance.

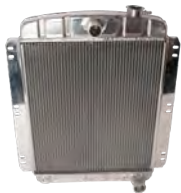

**3118968AL** .....47-54  
V8 Chevy Trucks 1.219 -0.15 ..... \$278.00 EA ⚠

**HUFSRAD** ..... 48-54  
Hudson cars 1.219 -0 .. \$399.00 EA ⚠

**Radiator V8 (Aluminum), cont.**



**3130944AL** .....49-54  
Chevy Cars W/ V8 1.219 -0.15 ..... \$279.50 EA ⚠

**FORDRAD** ..... 54-56  
Ford / Mercury Cars 1.219 -0  
..... \$229.00 EA ⚠

**FORDRADF** ..... 54-56  
Ford / Mercury Cars, W/ 2600CFM 16"  
fan. 1.219 -0 ..... \$349.00 EA ⚠

**FORDRADPL** ..... 54-56  
Ford / Mercury Cars, Polished 1.219 -0  
..... \$259.00 EA ⚠

**CHEVRAD01** ..... 55-56  
Car 1.219 -0 ..... \$199.00 EA ⚠

**CHEVRAD02** ..... 55-56  
Car 1.219 -0 ..... \$338.00 EA ⚠

**FORDTRAD** ..... 55-57  
T-Bird 1.219 -0 ..... \$229.00 EA ⚠

**FORDTRADF** ..... 55-57  
T-Bird, W/ 2600CFM fan and shroud  
1.219 -0 ..... \$368.00 EA ⚠

**FORDRAD** .....57-59  
Ford / Mercury Cars that came original  
with V8. Includes transmission cooler.  
1.219 -0.15 ..... \$279.00 EA ⚠

**FORDRAD6** .....57-59  
Ford / Mercury Cars 1.219 -0  
..... \$279.00 EA ⚠

**FORDRADPL** .....57-59  
Ford / Mercury Cars, polished 1.219 -0  
..... \$309.00 EA ⚠

**CADRAD** ..... 60-65  
Cadillac 1.219 -0 ..... \$229.00 EA ⚠

**CADRADSF** ..... 60-65  
Cadillac W/ 2600CFM fan and shroud  
1.219 -0 ..... \$368.00 EA ⚠

**Radiator V8 (Copper Brass)**



**313904541** .....40-41  
Chevy Car W/ V8 small block, 4 core w/  
trans cooler. 1.219 -0.15 ..... \$580.25 EA ⚠

**313904548** .....42-48  
Chevy Car W/ V8 small block, 4 core w/  
trans cooler. 1.219 -0.15 ..... \$580.50 EA ⚠

**3118968A** .....47-54  
Chevy Truck W/ V8 small block, 4 core w/  
trans cooler. 1.219 -0.15 .. \$398.75 EA ⚠

**Radiator V8 (Copper Brass), cont.**

**313904554** .....49-54  
Chevy Car V8 small block, 4 core w/ trans  
cooler. Includes U-nuts. 1.219 -0.15  
..... \$548.25 EA ⚠

**Radiator Petcock**



**134519** .....37-39  
Not as original. 1.229 -0.2 ..... \$4.99 EA ⚠



**3113456** .....40-47  
1/4" NPT 1.229 -0 ..... \$15.99 EA ⚠



**3719518** .....53-57  
1/4" NPT 1.229 -0.3 ..... \$4.25 EA ⚠

**Radiator Cap (Aluminum)**



**ALUMCAP16PRC** .....ALL  
Billet aluminum radiator cap. 16lb.  
Smooth finish. 0.000 -0.15 ... \$19.99 EA ⚠



**R5010** .....ALL  
Polished Aluminum Radiator Cap - Plain  
(16lb Pressure). -0.15 ... \$22.69 EA ⚠



**WARNING: Cancer and Reproductive Harm** —  
www.P65Warnings.ca.gov

NOTE: Any chemicals will be shipped domestic ground only (Lower 48 states only). No international shipping.



**Radiator Cap (Aluminum), cont.**



**R5011.....ALL**  
 Chrome Aluminum Radiator Cap - Plain  
 (16lb Pressure). -0.15 ... **\$22.75 EA** ⚠️

**Radiator Cap (Aluminum Billet Specialties)**

Polished with knurled grip. Billet Specialties billet aluminum radiator caps come unassembled so cap design may be lined up once on the radiator.



**BIS75120.....ALL**  
 Smooth billet cap with knurled grip side.  
 16lb pressure. 1.203 -0.15 ... **\$19.50 EA** ⚠️



**BIS75125.....ALL**  
 Notched Grip polished billet cap. 16lb  
 pressure. 1.203 -0.15 ... **\$24.25 EA** ⚠️



**BIS75125B.....ALL**  
 Notched Grip billet cap. 16lb pressure.  
 Black anodized 1.203 -0.15 .. **\$30.00 EA**  
 ⚠️



**BIS75220.....ALL**  
 Ball milled circles in billet cap with knurled  
 grip side. 16lb pressure. 1.203 -0  
 ..... **\$18.59 EA** ⚠️

**Radiator Cap (Aluminum Billet Specialties), cont.**



**BIS75320.....ALL**  
 Ball milled bowtie in billet cap with knurled  
 grip side. 16lb pressure. 1.203 -0.15  
 ..... **\$19.50 EA** ⚠️



**BIS75420.....ALL**  
 V8 in billet cap with knurled grip side. 16lb  
 pressure. 1.203 -0.15 ... **\$21.00 EA** ⚠️



**BIS76120.....ALL**  
 Smooth billet cap with knurled grip side.  
 7lb pressure. 1.203 -0.15 . **\$19.50 EA** ⚠️



**BIS76320.....ALL**  
 Ball milled bowtie in billet cap with knurled  
 grip side. 7lb pressure. 1.203 -0  
 ..... **\$18.59 EA** ⚠️



**BIS76420.....ALL**  
 V8 in billet cap with knurled grip side. 7lb  
 pressure. 1.203 -0 ..... **\$18.59 EA** ⚠️

**Overflow Tanks Stainless**

Stainless steel, round overflow tanks with knurled lid and mounting brackets. Choose from many sizes.



**R6072X.....ALL**  
 Stainless 2" x 13"  
 Overflow Tank  
 with Mounting  
 Bracket. -0.15  
 ..... **\$48.50 EA** ⚠️



**R6073X.....ALL**  
 Stainless 2" x 15"  
 Overflow Tank with  
 Mounting Bracket. -0.2  
 ..... **\$78.00 EA** ⚠️



**R6074X.....ALL**  
 Stainless 2"  
 x 17" Overflow Tank with Mounting  
 Bracket. -0.15  
 ..... **\$56.00 EA** ⚠️



**R6076X.....ALL**  
 Stainless 3" x 10"  
 Overflow Tank  
 with Mounting  
 Bracket. -0.15  
 ..... **\$60.50 EA** ⚠️



**SSOVER13....ALL**  
 13 " Highly Polished  
 Stainless Steel,  
 round tank w/ aluminum cap. Includes  
 mounting brackets and hardware. Fluid  
 capacity is 1-1/4 pints. 1.290 -0.15  
 ..... **\$62.75 EA** ⚠️



**SSOVER15....ALL**  
 15 " Highly Polished  
 Stainless Steel,  
 round tank w/ aluminum cap. Includes  
 mounting brackets and hardware. Fluid  
 capacity is 1-1/2 pints. 1.290 -0.15  
 ..... **\$63.50 EA** ⚠️



**SSOVER17....ALL**  
 17 " Highly Polished  
 Stainless Steel,  
 round tank w/ aluminum cap. Includes  
 mounting brackets and hardware. Fluid  
 capacity is 1-3/4 pints. 1.290 -0.15  
 ..... **\$59.50 EA** ⚠️



**Overflow Tanks Aluminum**

Billet aluminum, Polished round tank with clamps and smooth, seamless cap.



**AFC80158** . . . . .ALL  
All aluminum recovery tank. 7" tall, 3.5" in dia. Approx 1qt capacity. 1.290 -0  
..... **\$100.00 EA** ⚠



**ALUMOVER13** . .ALL  
13" Polished Billet Aluminum, round tank w/ mounting clamps & smooth finish cap. 1.290 -0.15  
..... **\$110.69 EA** ⚠

**ALUMOVER15** . . . . . ALL  
15" Polished Billet Aluminum, round tank w/ mounting clamps & smooth finish cap. 1.290 -0.15  
..... **\$110.69 EA** ⚠

**ALUMOVER17** . . . . .ALL  
17" Polished Billet Aluminum, round tank w/ mounting clamps & smooth finish cap 1.290 -0.15  
..... **\$110.75 EA** ⚠



**BIS77109** . . . . .ALL  
Smooth finish, polished. 8.75" long 2.875" dia, 15oz Capacity 6.635 -0.15  
..... **\$130.25 EA** ⚠

**Overflow Tank Chrome**



**R6570** . . . . .ALL  
Chrome w/ sight tube. 3" x 9", 24 oz. capacity. Red anodized cap and drain plug. Includes hose clamp

mount. -0.15  
..... **\$79.99 EA** ⚠

**Radiator Core Support Chevy**



**AU-2254** . . . . .37-39  
Bolt-in for Chassis Engineering IFS kit. 1.270 -0  
..... **\$105.00 EA** ⚠  
**AU-2256** . . . . . 40  
Bolt-in for NON Chassis Engineering IFS kit. 1.270 -0  
..... **\$105.00 EA** ⚠

**Radiator Core Support Chevy, cont.**

**AU-2257** . . . . . 40  
Bolt-in for Chassis Engineering IFS kit. 1.270 -0  
..... **\$105.00 EA** ⚠  
**AU-2255** . . . . . 41-48  
Bolt-in for Chassis Engineering or any other IFS kit. 1.270 -0  
... **\$105.00 EA** ⚠

**Electric Fans Maradyne Champion Low Profile Series**

Champion Series Low Profile fans are the highest performance reversible fans on the market. 12 volt, sealed (water and dust proof) motors with quiet, reversible S-Blades. Mount as push or pull. Includes (4) 90 degree mounting feet, mating pigtail connector and nylon pull thru tie kit. Recommended wire harnesses sold separately (listed after fans).



**M122K** . . . . .ALL  
12" 1,565cfm. 225 watt heavy duty. 3.19" depth, 18.0 amp draw. -0.15  
..... **\$163.00 EA** ⚠

**M142K** . . . . . ALL  
14" 2,135cfm. 225 watt heavy duty. 3.19" depth, 17.2 amp draw. -0.15  
..... **\$145.00 EA** ⚠

**M146K** . . . . . ALL  
14" 1,555cfm. 160 watt heavy duty. 2.87" depth, 10.1 amp draw. -0.15  
..... **\$147.00 EA** ⚠

**M162K** . . . . . ALL  
16" 2,170cfm. 225 watt heavy duty. 3.19" depth, 18.0 amp draw. -0.15  
..... **\$178.75 EA** ⚠

**Electric Fans Maradyne Challenger Series**

Challenger Series fans offer economical fans good for high performance or daily drivers. 12 volt, Heavy Duty motors with quiet, reversible S-Blades. Mount as push or pull. Includes (4) 90 degree mounting feet, mating pigtail connector and nylon pull thru tie kit. Recommended wire harnesses sold separately (listed after fans).

**Electric Fans Maradyne Challenger Series, cont.**



**MC162K** . . . . .ALL  
16" 2,200cfm. 225 watt heavy duty. 4.35" depth, 18.9 amp draw. -0.15  
..... **\$124.25 EA** ⚠

**MC166K** . . . . . ALL  
16" 1,950cfm. 160 watt heavy duty. 3.87" depth, 13.1 amp draw. -0.15  
..... **\$117.00 EA** ⚠

**Electric Fan 12 Volt**

Absolutely superior cooling! Current draw is a serious concern with all the electronics being used these days. These fans draw less current with more CFM than other fans on the market. The CFM is rated with resistance of the radiator in place, not free flow. Superior motor winding, ball bearings & a balanced fan to motor assembly improves efficiency & reduces current draw on your vehicle.



**100120R** . . . . .ALL  
12" (12v) straight blade, 1390 CFM, push or pull, only draws 8.6 amps. 1.064 -0.15  
..... **\$77.00 EA** ⚠

**100140R** . . . . . ALL  
14" (12v) straight blade, 1590 CFM, push or pull, only draws 9.8 amps. 1.064 -0.15  
..... **\$82.09 EA** ⚠

**100160R** . . . . . ALL  
16" (12v) straight blade, 1940 CFM, push or pull, only draws 10.6 amps. 1.064 -0.15  
..... **\$88.00 EA** ⚠

**Electric Fan 6 Volt**



**30100382A** . . . . .ALL  
14" straight blade. PUSH (front of radiator) 6v, 1125 CFM. Complete w/ wiring & brackets. 1.064 -0.15  
..... **\$199.49 EA** ⚠

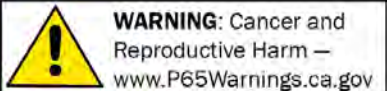

**WARNING: Cancer and Reproductive Harm** —  
www.P65Warnings.ca.gov

NOTE: Any chemicals will be shipped domestic ground only (Lower 48 states only). No international shipping.

**Electric Fan 6 Volt, cont.**

**30100385A** ..... ALL  
 14" straight blade. PULL (backside of radiator), 6v, 1125 CFM. Complete w/ wiring & brackets. 1.064 -0.15 **\$200.00 EA**  
 ⚠️

**Electric Fan Mounting Bracket Kit**



**30130011** ..... ALL  
 Steel blades to mount most electric fans with slots on outside fan housing. 1.064 -0.15 **\$25.00 SET** ⚠️

**Electric Fan Harness**



**MFA100** ..... ALL  
 Adjustable temp switch, harness & relay. -0.15 **\$75.50 EA** ⚠️  
**MFA102** ..... ALL  
 185 degree switch, harness & relay. -0.15 **\$75.50 EA** ⚠️  
**MFA103** ..... ALL  
 195 degree switch, harness & relay. -0.15 **\$74.00 EA** ⚠️

**Fan Temp Control Switches**



**AR-99** ..... ALL  
 This innovative Fan Controller can operate two fans at different temperatures or a single two speed fan at different temperatures. Adjustable operating range of approximately 140 degrees to 230 degrees with our exclusive lug sensor that mounts under almost any engine bolt. Creatively reduces surges on your alternator and engine. Works with or without A/C request. Come complete with heavy gauge crosslinked wire heavy enough to carry the load of these fans. -0 **\$151.75 EA** ⚠️

**Fan Temp Control Switches, cont.**



**ZFSDG** ..... ALL  
 Monitor and control any area of your vehicle with this digital temp controller. Unit sends a signal to a relay that activates your cooling fan for the programmed temp range you select from -20 degrees to 250 degrees Use on interior fans, speaker cooling fans, radiator fans, etc. Limited Lifetime warranty. 1.064 -0.15 **\$99.00 EA** ⚠️



**ZFSWA** ..... ALL  
 Manually adjust the operating temp for your radiator fan to switch on from 180 to 240 degrees. Great for keeping your engine at optimal operating temp. Limited Lifetime warranty. 1.064 -0.15 **\$35.00 EA** ⚠️

**Fan Shroud**

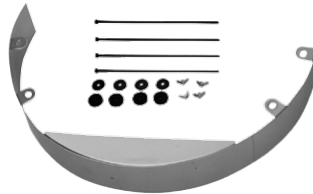

**R9453** ..... ALL  
 Chrome Fan Shroud - 3" Wide x 20" Diameter. -0.15 **\$30.25 EA** ⚠️



**R9453X** ..... ALL  
 Bolt Kit for Fan Shroud. -0.15 **\$7.50 EA** ⚠️

**Fan Shroud, cont.**



**R9454** ..... ALL  
 Chrome Fan Shroud - 5" Wide x 20" Diameter. -0.15 **\$33.50 EA** ⚠️

**Thermostat Housing (Billet Specialties)**

Precision machined 6061-T6 billet aluminum, polished to a mirror finish. Swivel housings with Positive O-ring seal eliminates need for gaskets or sealants.



**BIS90120** ..... ALL  
 Billet Specialties - Straight up design. 1.251 -0.15 **\$32.59 EA** ⚠️



**BIS90220** ..... ALL  
 Billet Specialties - 90 degree with full 360 degree swivel. 1.251 -0.15 **\$75.00 EA** ⚠️



**BIS90320** ..... ALL  
 Billet Specialties - 75 degree with full 360 degree swivel. 1.251 -0.15 **\$75.00 EA** ⚠️



**BIS90420** ..... ALL  
 Billet Specialties - 45 degree with full 360 degree swivel. 1.251 -0.15 **\$75.00 EA** ⚠️

**Thermostat Housing (Billet Specialties), cont.**



**BIS90620**.....ALL  
Billet Specialties - 90 degree with full 360 degree swivel. 1.251 -0.15 ... **\$95.00 EA** ⚠



**BIS90820**.....ALL  
Billet Specialties - Fits small and big block Chrysler engines & HEMI motors up to 1978. Straight-Up 1.251 -0.15  
..... **\$45.00 EA** ⚠

**Thermostat Housing O-Ring Type Chromed Aluminum**



**R6003C** .....ALL  
Chrome Aluminum SB Chevy O-Ring Water Neck - 40 Deg. Swivel. -0.15  
..... **\$29.50 EA** ⚠



**R6009C** .....ALL  
Chrome Aluminum SB Chevy O-Ring Water Neck - 90 Deg. Swivel. -0.15  
..... **\$28.75 EA** ⚠



**R6015C** .....ALL  
Chrome Aluminum 1966-75 SB Chevy 283-350 O-Ring Water Neck (15 degree). -0.15 ..... **\$26.79 EA** ⚠

**Thermostat Housing O-Ring Type Polished Aluminum**



**R6002**.....ALL  
Polished Aluminum SB Chevy O-Ring Water Neck - Straight Up. -0.15 **\$17.00 EA** ⚠



**R6003**.....ALL  
Polished Aluminum SB Chevy O-Ring Water Neck - 40 Deg. Swivel. -0.15  
..... **\$22.00 EA** ⚠



**R6009**.....ALL  
Polished Aluminum SB Chevy O-Ring Water Neck - 90 Deg. Swivel. -0.15  
..... **\$22.59 EA** ⚠



**R6015**.....ALL  
Polished Aluminum 1966-75 SB Chevy 283-350 O-Ring Water Neck (15 degree). -0.15 ..... **\$22.50 EA** ⚠

**Thermostat Housing O-Ring Type**



**R6004** .....ALL  
Replacement O-Ring for R6002, R6003, R6009, R6015 (Package of 2). -0.15  
..... **\$2.00 SET** ⚠

**Thermostat Housing O-Ring Type, cont.**



**R9229**.....ALL  
Chrome 1966-75 Late Chevy V8 O-Ring Water Neck. -0.15 ..... **\$13.49 EA** ⚠



**R9243** .....ALL  
Replacement O-Ring for R9228, R9229, R9230, R9468, R9647 (Package of 2). -0.15  
..... **\$1.59 SET** ⚠



**R9415**.....ALL  
Chrome Late Ford 429-460 O-Ring Water Neck. -0.15 ..... **\$24.50 EA** ⚠



**R9440**.....ALL  
Chrome 1965-75 Ford 260-289-302-351W O-Ring Water Neck. -0.15  
..... **\$12.25 EA** ⚠



**R9647**.....ALL  
Chrome Chevy "Straight-Up" O-Ring Water Neck. -0.15 ..... **\$25.50 EA** ⚠



**WARNING: Cancer and Reproductive Harm** —  
www.P65Warnings.ca.gov

NOTE: Any chemicals will be shipped domestic ground only (Lower 48 states only). No international shipping.

**Thermostat Housing Gasket Type**



**R4790**.....**ALL**  
 Chrome 1965-75 Ford 260-289-302-351W Gasket Water Neck 15 degree. -0.15  
 ..... **\$12.00 EA** ⚠



**R9524**.....**ALL**  
 Chrome Early Ford 390-428 Gasket Water Neck -0.15 ..... **\$15.75 EA** ⚠

**Radiator Hose Kits**

Dress up your engine bay with these Radiator Hose Kits. Each kit contains:

- 1 Stainless Steel hose; 1-3/4" O.D. (choose length)
- 2 aluminum end cap covers, Chrome or Polished (optional)
- 2 rubber hose sleeve adapters; 1-3/4" I.D.
- 4 rubber reducers; (2) 1-1/4" I.D., (2) 1-1/2" I.D.
- 4 hose clamps



**R7302**.....**ALL**  
 Chrome 12" Stainless Steel "Radiator" Hose Kit with Chrome Aluminum Caps. -0.15 ..... **\$56.50 EA** ⚠



**R7304**.....**ALL**  
 Chrome 24" Stainless Steel "Radiator" Hose Kit with Polished Aluminum Caps. -0.15 ..... **\$62.00 EA** ⚠

**R7308**.....**ALL**  
 Chrome 36" Stainless Steel "Radiator" Hose Kit with Chrome Aluminum Caps. -0.15 ..... **\$67.29 EA** ⚠

**Hose Reducer**



**R7317**.....**ALL**  
 1 3/4" Adapter with 1 1/2" & 1 1/4" Reducers and 2 Clamps for Radiator Hose (Package of 2). -0.15 ... **\$13.75 PR** ⚠

**Radiator Hose Clamps Thermal**

These heat-sensitive bands shrink to conform to any shape of hose and housing when heat is applied (even out-of-round fittings). Automatically readjusts every time the engine comes to operating temperature. After the engine is shut down, temperatures decrease and the clamp strengthens. Use a heat gun to secure clamps on and a soldering gun for removal.



**CLAMP1**.....**ALL**  
 1/2" I.D. (13/16" to 15/16" O.D.) hose. Solve leakage problems, even with out-of-round fittings. 1.166 -0.2

..... **\$6.00 EA** ⚠  
**CLAMP2**.....**ALL**  
 5/8" I.D. (15/16" to 1-1/16" O.D.) hose. Solve leakage problems, even with out-of-round fittings. 1.166 -0.4

..... **\$10.39 EA** ⚠  
**CLAMP3**.....**ALL**  
 1-1/4" I.D. (1-1/2" to 1-3/4" O.D.) hose. Solve leakage problems, even with out-of-round fittings. 1.166 -0.2

..... **\$8.69 EA** ⚠  
**CLAMP4**.....**ALL**  
 1-1/2" I.D. (1-3/4" to 2" O.D.) hose. Solve leakage problems, even with out-of-round fittings. 1.166 -0.3 ..... **\$13.19 EA** ⚠

**CLAMP5**.....**ALL**  
 1-3/4" I.D. (2" to 2-1/4" O.D.) hose. Solve leakage problems, even with out-of-round fittings. 1.166 -0.3 ..... **\$14.99 EA** ⚠

**Radiator Hose Clamp Covers**



**R7318**.....**ALL**  
 Polished Aluminum Radiator Hose Cap (Package of 2). -0.15 ... **\$14.09 PR** ⚠



**R7319**.....**ALL**  
 Chrome Aluminum Radiator Hose Cap (Package of 2). -0.15 ... **\$15.99 PR** ⚠

**Radiator Hose Clamps (Billet Specialties)**

Machined from billet aluminum with a polished finish.

**BIS67825**.....**ALL**  
 For 1-1/2" radiator hose. Machined from billet aluminum with a polished finish. 1.166 -0.15 ..... **\$21.50 EA** ⚠



**BIS67925**.....**ALL**  
 For 1-3/4" radiator hose. Machined from billet aluminum with a polished finish. 1.166 -0 ..... **\$20.50 EA** ⚠

**Hose Separators Billet Specialties**



**BIS68020**.....**ALL**  
 .440 x .540 polished aluminum. 8.950 -0.15 ..... **\$14.00 EA** ⚠

**BIS68025**.....**ALL**  
 .440 x .630 polished aluminum. 8.950 -0.15 ..... **\$14.00 EA** ⚠

**BIS68120**.....**ALL**  
 .500 x .500 polished aluminum. 8.950 -0 ..... **\$12.99 EA** ⚠

**BIS68125**.....**ALL**  
 .540 x .630 polished aluminum. 8.950 -0.15 ..... **\$14.00 EA** ⚠

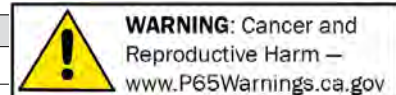

**Hose Separators Billet Specialties, cont.**

- BIS68220**..... ALL  
.562 x .562 polished aluminum. 8.950-0  
..... **\$12.99 EA** ⚠
- BIS68225**..... ALL  
.562 x .625 polished aluminum.  
8.950-0.15 ..... **\$14.00 EA** ⚠
- BIS68320**..... ALL  
.625 x .625 polished aluminum.  
8.950-0.15 ..... **\$14.00 EA** ⚠
- BIS68325**..... ALL  
.625 x .781 polished aluminum. 8.950-0  
..... **\$12.99 EA** ⚠
- BIS68420**..... ALL  
.734 x .890 polished aluminum. 8.950-0  
..... **\$12.99 EA** ⚠
- BIS68425**..... ALL  
.734 x .969 polished aluminum. 8.950-0  
..... **\$12.99 EA** ⚠
- BIS68520**..... ALL  
.781 x .781 polished aluminum. 8.950-0  
..... **\$12.99 EA** ⚠
- BIS68525**..... ALL  
.781 x .906 polished aluminum.  
8.950-0.15 ..... **\$14.00 EA** ⚠
- BIS68625**..... ALL  
.890 x .969 polished aluminum.  
8.950-0.15 ..... **\$14.00 EA** ⚠
- BIS68720**..... ALL  
.906 x .906 polished aluminum. 8.950-0  
..... **\$12.99 EA** ⚠
- BIS68725**..... ALL  
.906 x 1.015 polished aluminum.  
8.950-0.15 ..... **\$14.00 EA** ⚠
- BIS68729**..... ALL  
.906 x 1.125 polished aluminum.  
8.950-0.15 ..... **\$14.00 EA** ⚠
- BIS68820**..... ALL  
.906 x 1.125 polished aluminum. 8.950-0  
..... **\$12.99 EA** ⚠

**High Performance Water Pumps**

Ultra Light, Satin finish aluminum water pumps feature high quality roller bearings, custom machined impellers for maximum water flow and reduced cavitation at high RPMs.



- R3952**.....ALL  
Chevy SB. 71-91 Corvette (5-13/16" block to hub). Reverse Rotation. -0.15  
..... **\$126.19 EA** ⚠

**High Performance Water Pumps, cont.**



- R3953**.....ALL  
Chevy BB. 69-87 long water pump (7-5/16" block to hub). Will not fit Corvette. -0.15 ..... **\$143.75 EA** ⚠



- R3954**.....ALL  
Ford SB. 70-78 302 & 70-87 351W. Left inlet (5.70" block to hub). -0.15  
..... **\$107.25 EA** ⚠



- R3955**.....ALL  
MOPAR. 69-85 318 - 360 V8s. -0.15  
..... **\$97.00 EA** ⚠

**Water Pump Chevy 6 Cylinder**



- 3741033**.....**.29-54**  
W/ short shaft (narrow) 3/8" pulley (not polished). For use on 55 & later 235ci & 261ci engines (\$100 core). 1.069-0  
..... **CALL** ⚠



- 3741033LP**.....**.29-54**  
For doing a 235ci conversion in earlier chevys. Includes gasket for '55 & later 235ci & 261ci 6-cylinders. 1.069-0.3  
..... **\$140.00 EA** ⚠

**Water Pump Chevy 6 Cylinder, cont.**



- WPADAPT**.....ALL  
Water Pump Adapter Plate For 55 & Up 235, 261 Engines To Use Earlier 41-54 Water Pumps 1.069-0.2 ..... **\$45.00 EA** ⚠

**Water Pump Fitting**



- R9514**.....ALL  
Steel Water Pump Fitting - 1/2" NPT to 3/4" Barb. -0.15 ..... **\$7.25 EA** ⚠



- R9514X**.....ALL  
Aluminum Water Pump Fitting - 1/2" NPT to 3/4" Barb. -0.15 ..... **\$7.69 EA** ⚠

**Water Pump Pulley (Billet Specialties) Chevy**

Pulleys & covers are machined from 6061 T-6 billet aluminum for incredible balance & strength. 6-7/16" diameter. Top it off with a matching nose cover. For short or long water pumps.



- BIS78110**.....ALL  
Single groove, polished. Fits small and big block, long pump applications. Finish off the look with a polished nose cone part #BIS84220 (this section). 1.069-0.15  
..... **\$70.00 EA** ⚠

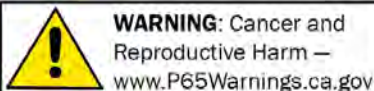

NOTE: Any chemicals will be shipped domestic ground only (Lower 48 states only). No international shipping.

**Water Pump Pulley (Billet Specialties) Chevy, cont.**



**BIS80120**.....**ALL**  
Single groove, polished. Fits small block, short pump applications. Finish off the look with a polished nose cone part #BIS84120. 1.069 -0.15 ..... **\$80.00 EA** ⚠



**BIS80220**.....**ALL**  
Double groove, polished. Fits small block, short pump applications. Finish off the look with a polished nose cone part #BIS84120 (this section). 1.069 -0.15 ..... **\$80.00 EA** ⚠



**BIS84120**.....**ALL**  
Short pump application. Finishes off the look of your water pump pulley. 1.069 -0.15 ..... **\$15.75 EA** ⚠



**BIS84220**.....**ALL**  
Pulley cover. Long pump application. Finishes off the look of your water pump pulley. 1.069 -0.15 ..... **\$17.00 EA** ⚠

**Water Pump Pulley Chevy SB SWP**

Water Pump pulleys for SB Chevy 283-350.  
Short Water Pump fits '55-'68  
Long Water Pump fits '69-'85



**R9479**.....**ALL**  
Satin Aluminum SB Chevy V8 Double Groove Water Pump Pulley - SWP Upper. -0.15 ..... **\$60.00 EA** ⚠



**R9488**.....**ALL**  
Satin Aluminum SB Chevy Water Pump Pulley Nose - SWP. -0.15 ... **\$15.25 EA** ⚠



**R9600**.....**ALL**  
Chrome SB Chevy 283-350 V8 Single Groove Water Pump Pulley - SWP Upper. -0.3 ..... **\$48.00 EA** ⚠

**Water Pump Pulley Chevy SB LWP**



**R9482**.....**ALL**  
Satin Aluminum SB Chevy V8 Single Groove Water Pump Pulley - LWP Upper. -0.15 ..... **\$37.50 EA** ⚠



**R9489**.....**ALL**  
Satin Aluminum SB Chevy Water Pump Pulley Nose - LWP. -0.15 ..... **\$15.89 EA** ⚠

**Water Pump Pulley Chevy SB LWP, cont.**



**R9604**.....**ALL**  
Chrome SB Chevy 283-350 V8 Single Groove Water Pump Pulley - LWP Upper. -0.15 ..... **\$23.50 EA** ⚠

**Water Pump Pulley Chevy BB LWP**

**R8844**.....**ALL**  
Satin Aluminum BB Chevy 1969-up V8 Double Groove Water Pump Pulley - LWP Upper. -0.15 ..... **\$58.00 EA** ⚠

**Water Pump Pulley Chevy BB SWP**

SWP-Short Water Pump fits '65-'68  
LWP-Long Water Pump fits '69-up



**R8840POL**.....**ALL**  
Polished Aluminum BB Chevy V8 Single Groove Pulley - SWP Upper. -0.15 ..... **\$49.00 EA** ⚠



**R8842POL**.....**ALL**  
Polished Aluminum BB Chevy V8 Double Groove Pulley - SWP Upper. -0.15 ..... **\$69.29 EA** ⚠



**R9815**.....**ALL**  
Chrome BB Chevy 396-454 V8 Double Groove Water Pump Pulley - SWP Upper. -0.15 ..... **\$29.25 EA** ⚠

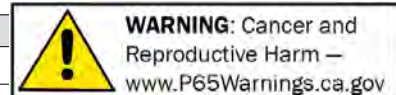

**Section 032: Front End Dress Kits, Engine Pulley Conversions**

**Water Pump Pulley Chevy Six Cylinder**



**598310**.....**37-38**  
 Aluminum (brushed finish). 1.069 -0  
 ..... **CALL** ⚠

**Water Pump Pulley Ford**



**R8970**.....**ALL**  
 Chrome Ford 1965-66 289 Single Groove  
 Pulley - Upper. -0.15 ..... **\$33.50 EA** ⚠



**R8973**.....**ALL**  
 Chrome Ford 1964-73 289 Double Groove  
 Pulley - Upper (For Calif. Smog Pump  
 Only). -0.15 ..... **\$39.75 EA** ⚠

**Billet Serpentine Pulley Systems. Chevy**

Chevy Small & Big Block Tru Trac Systems mount to engine block allowing any cylinder head/ intake configuration. All Hardware and Fasteners included (excluding power steering reservoir & lines). All aluminum billet pieces are precision machined and highly polished.

Kits Include:  
 New Polished Power Master 105 amp one wire alternator.

Aluminum Alternator Bracket  
 Aluminum Alt Fan and Pulley  
 Aluminum Support Bracket  
 New Edelbrock Aluminum Reverse Flow Water Pump (not included on LS1 kit)  
 Aluminum Water Pump Pulley with Hard Coat Anodized belt surface to reduce wear  
 Aluminum Tensioner Specifically Made For The System

Aluminum Tensioner Pulley with Hard Coat Anodized belt surface to reduce wear  
 Aluminum Crank Pulley  
 Stainless Fasteners  
 Serpentine Belt

Kits with A/C also include:  
 New Polished Sanden SD-7 Compressor with Polished Manifold Block and Fittings  
 Aluminum Compressor Bracket  
 Aluminum Compressor Cover  
 Kits with Power Steering also include:  
 New Aluminum Power Steering Pump (Sweet MFG.) with AN Fittings (-6&-10) Flow Tested and Pre Set to 850psi  
 Aluminum Power Steering Pulley  
 Aluminum Power Steering Bracket.  
 Power Steering Remote Reservoirs (not included in serpentine kit) are also available.

**IMPORTANT:** Although a supercharger or turbo set-up may work with the Tru Trac Pulley System, the system is NOT designed to be compatible with any specific brand or type of forced induction. Please contact the supercharger or turbocharger manufacturer to check for compatibility with the Billet Specialties Tru Trac Pulley System BEFORE purchase. Open Box Tru Trac Systems are NOT RETURNABLE.

**Billet Serpentine Pulley System. Chevy SB**



**BIS13120**.....**ALL**  
 With A/C, no power steering. 1.069 -0.15  
 ..... **\$1,979.99 SET** ⚠

**BIS13125**.....**ALL**  
 No A/C, no power steering. 1.069 -0.15  
 ..... **\$1,565.00 SET** ⚠

**BIS13220**.....**ALL**  
 With A/C & power steering. 1.069 -0.15  
 ..... **\$2,289.90 SET** ⚠

**BIS13225**.....**ALL**  
 With power steering, no A/C. 1.069 -0.15  
 ..... **\$1,925.25 SET** ⚠

**Billet Serpentine Pulley System. Chevy BB**



**BIS14120**.....**ALL**  
 With A/C, no power steering. 1.069 -0.15  
 ..... **\$2,080.00 SET** ⚠



**BIS14125**.....**ALL**  
 No A/C, no power steering. 1.069 -0.15  
 ..... **\$1,650.00 SET** ⚠

**BIS14220**.....**ALL**  
 With A/C & power steering. 1.069 -0.15  
 ..... **\$2,390.00 SET** ⚠

**BIS14225**.....**ALL**  
 With power steering, no A/C. 1.069 -0.15  
 ..... **\$2,030.00 SET** ⚠

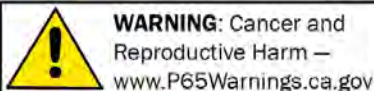

NOTE: Any chemicals will be shipped domestic ground only (Lower 48 states only). No international shipping.



**Billet Serpentine Pulley & Bracket Kit. Chevy BB**



**BISFM2222PC**.....ALL  
 Fits GM 60-80amp alternators. Mid mount on passenger side. Includes alt bracket, pulley w/ fan & nosecone, water pump pulley w/ nosecone, crank pulley, Saginaw power steering pump bracket and pulley and stainless hardware. 1.069 -0.15  
 ..... **\$550.50 SET** ⚠

**V-Belt Engine Accessory Drive Kit (Billet Specialties) Chevy SB**

**BISV3120**..... ALL  
 Complete front end V-belt engine dress kit. Includes Edelbrock high-performance water pump. Fully polished components w/ air cond and alternator. SB. -0.15  
 ..... **\$1,260.00 KIT** ⚠



**BISV3220**.....ALL  
 Complete front end V-belt engine dress kit. Includes Edelbrock high-performance water pump. Fully polished components w/ air cond, alternator & power steering. Fits Small Block Chevy. -0.15  
 ..... **\$1,465.00 KIT** ⚠

**V-Belt Engine Accessory Drive Kit (Billet Specialties) Chevy BB**

**BISV4120**..... ALL  
 Complete front end V-belt engine dress kit. Includes Edelbrock high-performance water pump. Fully polished components w/ air cond and alternator. BB. -0.15  
 ..... **\$1,360.00 KIT** ⚠



**BISV4220**.....ALL  
 Complete front end V-belt engine dress kit. Including Edelbrock high-performance water pump. Fully polished components w/ air cond, alternator & power steering. BB. -0.15  
 ..... **\$1,565.00 KIT** ⚠

**Chevy LS1-LS6**

Billet Specialties has created a Tru Trac for GM's most sought after motor - the Gen III small block. All components are arranged for the most compact system possible - giving you up to 4" more clearance than typical bracket kits on the market. But keep in mind, a Tru Trac is much more than just a bracket kit! This complete serpentine system includes everything you need from the best brands in the industry.

This new system has been designed for mounting accessories below the valve covers and in between the width of the heads. Precision CNC machined from 6061-T6 aluminum for strength and perfect fit. Hardcoated on high wear areas. Clear coated to eliminate polishing in those hard to reach places. Includes:

- Polished Sanden A/C compressor
- Polished Custom March Alternator
- Aluminum reverse rotation water pump
- GM Type 2 power steering pump
- OEM tensioner
- A/C bracket & nose cover with sculpted pockets
- Alternator bracket
- P/S bracket and housing cover
- Crank pulley
- Water pump pulley with fairing and nose cover with sculpted pockets
- Alternator pulley with machined fan and nose cover
- Wing emblem
- Polished A/C Fittings
- Superior grade 8 mounting hardware
- All nose covers
- Power steering housing cover
- Tensioner housing cover

IMPORTANT: Although a supercharger or turbo set-up may work with the Tru Trac Pulley System, the system is NOT designed to be compatible with any specific brand or type of forced induction. Please contact the supercharger or turbocharger manufacturer to check for compatibility with the Billet Specialties Tru Trac Pulley System BEFORE purchase. Open Box Tru Trac Systems are NOT RETURNABLE.

**Billet Serpentine Pulley System Chevy LS1-LS6 Low Mount**



**BIS13450**.....ALL  
 With A/C & power steering. -0.15  
 ..... **\$2,805.00 SET** ⚠  
**BIS13455**..... ALL  
 No A/C, with power steering. -0.15  
 ..... **\$2,445.00 SET** ⚠  
**BIS13470**..... ALL  
 With A/C, no power steering. -0.15  
 ..... **\$2,494.39 SET** ⚠  
**BIS13475**..... ALL  
 No A/C, no power steering. -0.15  
 ..... **\$2,080.00 SET** ⚠

**Billet Serpentine Pulley System. Chevy LS7 Top Mount**

**BIS13460P**..... ALL  
 With A/C & power steering. -0.15  
 ..... **\$2,780.00 SET** ⚠  
**BIS13465P**..... ALL  
 No A/C & With power steering. -0.15  
 ..... **\$2,420.00 SET** ⚠  
**BIS13490A**..... ALL  
 With A/C & No power steering. -0.15  
 ..... **\$2,805.00 SET** ⚠  
**BIS13495A**..... ALL  
 No A/C & No power steering. -0.15  
 ..... **\$2,320.00 SET** ⚠

**Sport Trac Serpentine System Chevy LS**



**BIS12500**.....ALL  
 Includes:  
 170 amp Powermaster one-wire alternator  
 Genuine Sanden SD-7 AC Compressor  
 Tuff Stuff Performance new aluminum power steering pump and reservoir  
 Power steering hard line for pressure side  
 Tensioner  
 6-rib serpentine belt  
 Precision Machined Brackets and pulleys  
 Precision Machined AC Compressor manifold -0  
 ..... **\$1,499.99 EA** ⚠

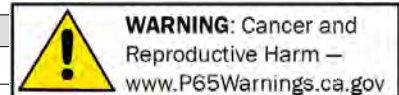

**Billet Serpentine Pulley Systems. Ford**

The most complete serpentine systems on the market! Billet Specialties Tru Trac serpentine systems are engineered to bolt right on and align perfectly without the need for stabilizer brackets or adjuster bars. CNC machined and polished to a mirror finish, the Tru Trac not only looks awesome - it performs! Tru Trac serpentine systems increase the efficiency of the alternator and compressor by eliminating belt slippage

Quality is abundant in every aspect of each Tru Trac serpentine system. Every bracket and pulley is machined from 6061-T6 billet aluminum for exceptional strength and rigidity. Each polished stainless steel fastener features a 12-point head for optimum contact and an aggressive finished look. Select pulleys are hardcoat anodized for increased durability, preventing wear from the backside of the serpentine belt. The exclusive patent-pending billet tensioner eliminates the need for constant re-adjustment.

**Billet Serpentine Pulley Systems. Ford, cont.**

Tru Trac Serpentine Systems Include:  
 Polished Powermaster 105 amp 1-wire alternator  
 Polished billet aluminum 1pc. alternator fan & pulley  
 Natural finish Ford Racing reverse rotation water pump (SB)  
 Natural finish Edelbrock standard rotation water pump (BB & FE)  
 Polished billet aluminum water pump pulley  
 Polished billet aluminum bridge bracket  
 Patent-pending polished billet aluminum tensioner engineered specifically for each Tru Trac serpentine system  
 Polished billet aluminum tensioner pulley  
 Polished billet aluminum crankshaft pulley  
 Polished ARP 12-point stainless steel fasteners  
 Goodyear Gatorback 6-rib serpentine belt  
 Comprehensive installation manual  
 Select pulleys are hard-coat anodized for increased durability in high wear areas

Kits With AC Include:  
 Polished Sanden SD-7 AC compressor  
 Polished billet aluminum AC compressor clutch cover  
 Patented polished billet aluminum AC compressor manifold

Kits With Power Steering Include:  
 Natural finish Maval Mfg. power steering pump with AN fittings  
 Polished billet aluminum power steering pulley

**IMPORTANT:** Although a supercharger or turbo set-up may work with the Tru Trac Pulley System, the system is NOT designed to be compatible with any specific brand or type of forced induction. Please contact the supercharger or turbocharger manufacturer to check for compatibility with the Billet Specialties Tru Trac Pulley System BEFORE purchase. Open Box Tru Trac Systems are NOT RETURNABLE.

**Billet Serpentine Pulley System. Ford SB 289/302/351W**



**BIS13600.....ALL**  
 With A/C & power steering. 1.069 -0.15  
 ..... **\$2,495.00 SET** ⚠



**BIS13605.....ALL**  
 With power steering, no A/C. 1.069 -0.15  
 ..... **\$2,080.00 SET** ⚠  
**BIS13620..... ALL**  
 With A/C, no power steering. 1.069 -0.15  
 ..... **\$2,134.50 SET** ⚠  
**BIS13625..... ALL**  
 No A/C, no power steering. 1.069 -0.15  
 ..... **\$1,700.00 SET** ⚠

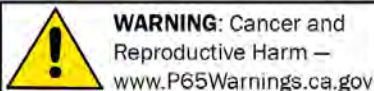

NOTE: Any chemicals will be shipped domestic ground only (Lower 48 states only). No international shipping.

**Ford Big Block**

**KITS INCLUDE:**

- Patent-pending polished all-billet timing cover - supports all Tru Trac components
- New Edelbrock high-performance water pump
- Polished billet aluminum water pump pulley
- New polished Sanden SD-7 compressor
- Patent-pending polished billet aluminum compressor manifold
- Polished billet aluminum compressor clutch cover
- New polished Powermaster 105 amp one-wire alternator
- Polished billet aluminum 1pc. alternator pulley & fan
- Patent-pending polished billet aluminum tensioner engineered specifically for the Tru Trac system
- Polished & hard-coat anodized billet aluminum tensioner & idler pulleys for added durability
- New Sweet Mfg. power steering pump with AN fittings
- Polished billet aluminum power steering pulley
- Polished billet aluminum crankshaft pulley
- Polished billet aluminum bridge bracket
- 12pt. ARP polished stainless steel fasteners
- Goodyear Gatorback Poly-V serpentine belt
- Comprehensive instruction booklet

**IMPORTANT:** Although a supercharger or turbo set-up may work with the Tru Trac Pulley System, the system is NOT designed to be compatible with any specific brand or type of forced induction. Please contact the supercharger or turbocharger manufacturer to check for compatibility with the Billet Specialties Tru Trac Pulley System BEFORE purchase. Open Box Tru Trac Systems are NOT RETURNABLE.

**Billet Serpentine Pulley System. Ford BB 429/460**



- BIS14600.....ALL**  
With A/C & power steering. 1.069 -0.15  
..... **\$2,700.00 SET** ⚠
- BIS14605.....ALL**  
With power steering, no A/C. 1.069 -0.15  
..... **\$2,290.00 SET** ⚠
- BIS14620.....ALL**  
With A/C, no power steering. 1.069 -0.15  
..... **\$2,340.00 SET** ⚠

**Billet Serpentine Pulley System. Ford BB 429/460**

- BIS14625.....ALL**  
No A/C, no power steering. 1.069 -0.15  
..... **\$1,930.00 SET** ⚠

**Ford FE**

Available in four configurations to fit any FE application, the Tru Trac for Ford FE is available with or without a/c and with or without power steering. With all components positioned within the silhouette of the engine block the Tru Trac for FE will fit many applications where space is limited and maximum power is required. Even with its compact design, the Tru Trac for Ford FE will command the attention of all who peek under the hood!

Tru Trac for Ford FE includes:  
Precision machined and polished billet aluminum brackets & pulleys  
New polished Powermaster 105-amp one-wire alternator  
New polished Sanden SD-7 compressor with patented A/C manifold block  
New Edelbrock high-performance water pump  
Polished billet aluminum tensioner specifically made for this system  
Polished ARP 12pt stainless fasteners  
Goodyear Gatorback serpentine belt

Kit with power steering also includes:  
New Maval Mfg. GM type-II power steering pump  
Polished billet aluminum bracket and pulley

**IMPORTANT:** Although a supercharger or turbo set-up may work with the Tru Trac Pulley System, the system is NOT designed to be compatible with any specific brand or type of forced induction. Please contact the supercharger or turbocharger manufacturer to check for compatibility with the Billet Specialties Tru Trac Pulley System BEFORE purchase. Open Box Tru Trac Systems are NOT RETURNABLE.

**Billet Serpentine Pulley System. Ford FE**



- BIS14700.....ALL**  
With A/C & power steering. 1.069 -0.15  
..... **\$2,595.00 SET** ⚠



- BIS14705.....ALL**  
With power steering, no A/C. 1.069 -0.15  
..... **\$2,185.00 SET** ⚠
- BIS14720.....ALL**  
With A/C, no power steering. 1.069 -0.15  
..... **\$2,235.00 SET** ⚠
- BIS14725.....ALL**  
No A/C, no power steering. 1.069 -0.15  
..... **\$1,825.00 SET** ⚠



**Billet Serpentine Pulley Systems. Chrysler**

Billet Specialties Chrysler Tru Trac is without a peer as the most complete and efficient accessory drive on the market. Rule the streets with a Tru Trac

Quality is abundant in every aspect of each Tru Trac serpentine system. Every bracket and pulley is machined from 6061-T6 billet aluminum for exceptional strength and rigidity. Each polished stainless steel fastener features a 12-point head for optimum contact and an aggressive finished look. Select pulleys are hardcoat anodized for increased durability, preventing wear from the backside of the serpentine belt. The exclusive patent-pending billet tensioner eliminates the need for constant re-adjustment.

IMPORTANT: Although a supercharger or turbo set-up may work with the Tru Trac Pulley System, the system is NOT designed to be compatible with any specific brand or type of forced induction. Please contact the supercharger or turbocharger manufacturer to check for compatibility with the Billet Specialties Tru Trac Pulley System BEFORE purchase. Open Box Tru Trac Systems are NOT RETURNABLE.

**Billet Serpentine Pulley System. Chrysler SB 318/340/360**



- BIS13800**.....ALL  
With A/C & power steering. -0.15  
..... **\$2,645.00 SET** ⚠
- BIS13805**..... ALL  
With power steering, no A/C. -0.15  
..... **\$2,185.00 SET** ⚠
- BIS13820**..... ALL  
With A/C, no power steering. -0.15  
..... **\$2,235.00 SET** ⚠
- BIS13825**..... ALL  
No A/C, no power steering. -0.15  
..... **\$1,825.00 SET** ⚠

**Chrysler BB & HEMI**

Applications:  
426, 472, & 528 HEMI CRATE  
66 & UP 426 STREET HEMI  
BIG BLOCK 383 & 440 B/RB (58-78)

**Billet Serpentine Pulley System. Chrysler BB & HEMI**



- BIS14800**.....ALL  
With A/C & power steering. -0.15  
..... **\$3,010.00 SET** ⚠
- BIS14805**..... ALL  
With power steering, no A/C. -0.15  
..... **\$2,595.00 SET** ⚠
- BIS14820**..... ALL  
With A/C, no power steering. -0.15  
..... **\$2,650.00 SET** ⚠
- BIS14825**..... ALL  
No A/C, no power steering. -0.15  
..... **\$2,235.00 SET** ⚠

**Pontiac 326-455**

It's Game On for Pontiac power plants as the void in performance accessory drives has been filled. Billet Specialties has answered your requests with the all-new Tru Trac for the 326/455 Pontiac. Using the proven Tru Trac Formula of quality, ease of assembly, name brand components & superior engineering the Tru Trac for Pontiac is sure to be a hit.

- Tru Trac Serpentine Systems Include:
- Polished Powermaster 105 amp 1-wire alternator
  - Polished billet aluminum 1pc. alternator fan & pulley
  - Natural finish Edelbrock standard rotation water pump
  - Polished billet aluminum water pump pulley
  - Polished billet aluminum bridge bracket
  - Patent-pending polished billet aluminum tensioner engineered specifically for each Tru Trac serpentine system
  - Polished billet aluminum tensioner pulley
  - Polished billet aluminum crankshaft pulley
  - Polished ARP 12-point stainless steel fasteners
  - Goodyear Gatorback 6-rib serpentine belt
  - Comprehensive installation manual
  - Select pulleys are hard-coat anodized for increased durability in high wear areas.
  - Kits With AC Include:
    - Polished Sanden SD-7 AC compressor
    - Polished billet aluminum AC compressor clutch cover
    - Patented polished billet aluminum AC compressor manifold
  - Kits With Power Steering Include:
    - Natural finish Maval Mfg. power steering pump with AN fittings
    - Polished billet aluminum power steering pulley

IMPORTANT: Although a supercharger or turbo set-up may work with the Tru Trac Pulley System, the system is NOT designed to be compatible with any specific brand or type of forced induction. Please contact the supercharger or turbocharger manufacturer to check for compatibility with the Billet Specialties Tru Trac Pulley System BEFORE purchase. Open Box Tru Trac Systems are NOT RETURNABLE.

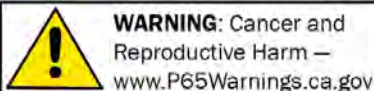

NOTE: Any chemicals will be shipped domestic ground only (Lower 48 states only). No international shipping.

**Billet Serpentine Pulley System.  
Pontiac 326/455**



- BIS14900**.....ALL  
With A/C & power steering. 1.069 -0.15  
..... **\$2,595.00 SET** ⚠️
- BIS14905**..... ALL  
With power steering, no A/C. 1.069 -0.15  
..... **\$2,185.00 SET** ⚠️



- BIS14920**.....ALL  
With A/C, no power steering. 1.069 -0.15  
..... **\$2,235.00 SET** ⚠️
- BIS14925**..... ALL  
No A/C, no power steering. 1.069 -0.15  
..... **\$1,825.00 SET** ⚠️

**Power Steering Pump**



- R3913** ..... ALL  
Chrome GM Saginaw  
1973-up Power  
Steering Pump. -0.15  
..... **\$218.25 EA** ⚠️

**Power Steering Remote Pump  
(Billet Specialties)**



- BIS12020**.....ALL  
New aluminum steering pump. Each pump  
is tested and preset to 850psi. Includes  
-6AN pressure & -10AN supply fittings  
installed on pump. Remanufactured  
pumps or salvage yard pumps can  
produce a wide range of pressure levels  
causing the steering of your vehicle to be  
stiff or notchy. 1.069 -0.15 . **\$195.00 EA**  
⚠️

**Power Steering Remote Pump  
(Billet Specialties), cont.**



- BIS77900**.....ALL  
Use with Tru-Trac or V-Trac front dress kits.  
Fits most GM boxes & Ford racks. Includes  
braided lines and adapters. -0.15  
..... **\$199.50 SET** ⚠️

**Power Steering Remote Reservoir  
(Billet Specialties)**



- BIS77910** .... ALL  
Smooth finish.  
6.635 -0.15  
..... **\$155.25 EA** ⚠️



- BIS77920** .... ALL  
Ribbed finish.  
6.635 -0.15  
..... **\$155.25 EA** ⚠️

**Power Steering Remote Reservoir**



- AFC37152** .... ALL  
Aluminum Power  
Steering Reservoir  
Firewall Mount.  
1.290 -0.15  
..... **\$131.29 EA** ⚠️

**Power Steering Components Chevy**

Engineered to work with GM remote type  
II power steering pumps. Billet Specialties  
power steering bracket and pulley is precision  
machined from 6061-T6 billet aluminum and  
mounts low on the driver's side of the motor.  
Check for clearance before ordering, from  
center of crank to outer edge of power steering  
pulley is 11 inches. Available for short or long  
water pumps.

**Power Steering Components Chevy,  
cont.**



- BIS12120**.....ALL  
Short water pump, small block. 6.606 -0.15  
..... **\$170.00 SET** ⚠️
- BIS12220**..... ALL  
Long water pump, small block. 6.606 -0.15  
..... **\$170.25 SET** ⚠️



- PS-101** .....ALL  
Power Steering Adjustable Valve -Heidts  
6.008 -0.4 ..... **\$101.00 EA** ⚠️

**Power Steering Hose Kits**



- GOT131102** .....ALL  
Stock "stage II" GM pump to remote  
reservoir w/ 1/2" pipe return fitting (Street  
& Performance, Mullin's) requires a base  
hose kit. -0.15 ..... **\$72.75 SET** ⚠️
- GOT131105**..... ALL  
Ford rack to GM pump ( steel rack,  
Mustang II & Pinto, with "bolt-on"  
pinion. -0.15 ..... **\$165.75 SET** ⚠️
- GOT131106**..... ALL  
Stock "stage II" GM pump to remote  
reservoir w/ 3/8" pipe return fitting  
(ZOOP'S etc.) requires a base hose  
kit. -0.15 ..... **\$65.25 SET** ⚠️
- GOT131109**..... ALL  
Stock "stage II" GM pump to remote  
reservoir w/ 3/8" pipe return fitting  
(ZOOP'S etc.) requires a base hose  
kit. -0.15 ..... **\$65.25 SET** ⚠️
- GOT131151**..... ALL  
1979 and Earlier GM gearbox to GM  
pump. -0.15 ..... **\$165.75 SET** ⚠️
- PS-111** ..... ALL  
GM remote res w/o adjustable valve.  
6.008 -0 ..... **\$186.00 SET** ⚠️

**Power Steering Hose Kits**



**PS-113** .....ALL  
 GM remote res w/ adjustable valve.  
 6.008-0 ..... **\$254.00 EA** ⚠

**Power Steering Hose Fittings**



**GOT131908** .....ALL  
 #8-AN x 5/8" hose barb, 90 degree. For  
 Street & Performance P/S pumps. -0.15  
 ..... **\$16.75 EA** ⚠



**GOT131910** .....ALL  
 #10-AN x 5/8" hose barb, 90 degree. Fits  
 Detroit Speed & Engineering and Zoop's  
 P/S pumps. -0.15 ..... **\$16.75 EA** ⚠



**PS-114** .....ALL  
 Install kit. 6.008-0.4 ..... **\$80.00 EA** ⚠

**Power Steering Hose Fitting**



**GOT601906** .....ALL  
 #6-AN x 5/8" hose barb, 90 degree. Fits  
 Detroit Speed & Engineering and Zoop's  
 P/S pumps. -0.15 ..... **\$15.75 EA** ⚠

**Power Steering Pulleys (Billet Specialties) Chevy SB**

These Billet Specialties pulleys fit SB Chevy engines. Machined from 6061 T-6 billet aluminum for incredible strength & balance and come highly polished.



**BIS86120** .....ALL  
 Single groove, polished. Fits small block,  
 1/8" keyway shaft steering pump with  
 built-in reservoir. Machined from 6061 T-6  
 billet aluminum. Fits short or long water  
 pump applications. 1.069-0  
 ..... **\$55.79 EA** ⚠

**Power Steering Pump Pulleys Chevy**



**R8847** .....ALL  
 Satin Aluminum Early GM Double Groove  
 Power Steering Pulley. -0.15  
 ..... **\$46.75 EA** ⚠



**R8847POL** .....ALL  
 Polished Aluminum Early GM Double  
 Groove Power Steering Pulley. -0.15  
 ..... **\$56.25 EA** ⚠



**R8848** .....ALL  
 Satin Aluminum Early GM Single Groove  
 Power Steering Pulley. -0.15  
 ..... **\$40.69 EA** ⚠

**Power Steering Pump Pulleys Chevy**



**R8947** .....ALL  
 Chrome Early GM Double Groove Power  
 Steering Pump Pulley. -0.15  
 ..... **\$31.19 EA** ⚠

**Crankshaft Pulley (Billet Specialties) Chevy**

These Billet Specialties pulleys fit SB Chevy engines. Machined from 6061 T-6 billet aluminum for incredible strength and balance. All are 6-7/16" dia. and come highly polished.



**BIS78220** .....ALL  
 Double groove, polished. Fits small block,  
 long water pump applications. 1.069-0.15  
 ..... **\$65.00 EA** ⚠



**BIS81120** .....ALL  
 Single groove, polished. Fits small block,  
 short water pump applications. 1.069-0  
 ..... **\$60.00 EA** ⚠



**BIS81220** .....ALL  
 Double groove, polished. Fits small block,  
 short water pump applications. 1.069-0.15  
 ..... **\$65.00 EA** ⚠



**WARNING:** Cancer and  
 Reproductive Harm —  
[www.P65Warnings.ca.gov](http://www.P65Warnings.ca.gov)

NOTE: Any chemicals will be shipped domestic ground only (Lower 48 states only). No international shipping.

# Section 032: Front End Dress Kits, Engine Pulley Conversions

## Crankshaft Pulley (RPC) Chevy SB, Polished Aluminum

Crankshaft pulleys for SB Chevy 283-350.



**R8858POL** .....ALL  
Polished Aluminum SB Chevy V8 Triple Groove Pulley - SWP Lower. -0.15  
..... **\$70.79 EA** ⚠

**R9481POL** .....ALL  
Polished Aluminum SB Chevy V8 Double Groove Crankshaft Pulley - SWP Lower. -0.15  
..... **\$49.69 EA** ⚠



**R9484POL** .....ALL  
Polished Aluminum SB Chevy V8 Single Groove Crankshaft Pulley - LWP Lower. -0.15  
..... **\$62.00 EA** ⚠

## Crankshaft Pulley (RPC) Chevy SB, Satin Aluminum



**R9480** .....ALL  
Satin Aluminum SB Chevy V8 Single Groove Crankshaft Pulley - SWP Lower. -0.15  
..... **\$32.49 EA** ⚠



**R9481** .....ALL  
Satin Aluminum SB Chevy V8 Double Groove Crankshaft Pulley - SWP Lower. -0.15  
..... **\$42.94 EA** ⚠

## Crankshaft Pulley (RPC) Chevy SB, Satin Aluminum, cont.



**R9484** .....ALL  
Satin Aluminum SB Chevy V8 Single Groove Crankshaft Pulley - LWP Lower. -0.15  
..... **\$52.50 EA** ⚠



**R9485** .....ALL  
Satin Aluminum SB Chevy V8 Double Groove Crankshaft Pulley - LWP Lower. -0.15  
..... **\$55.99 EA** ⚠



**R9486** .....ALL  
Satin Aluminum SB Chevy V8 Triple Groove Crankshaft Pulley - LWP Lower. -0.15  
..... **\$56.25 EA** ⚠

## Crankshaft Pulley (RPC) Chevy SB, Chrome



**R8963** .....ALL  
Chrome SB Chevy Triple Groove Pulley - SWP Lower. -0.15  
..... **\$47.79 EA** ⚠



**R9603** .....ALL  
Chrome SB Chevy 283-350 V8 Double Groove Crankshaft Pulley - SWP Lower. -0.15  
..... **\$28.99 EA** ⚠

## Crankshaft Pulley (RPC) Chevy SB, Chrome, cont.



**R9606** .....ALL  
Chrome SB Chevy 283-350 V8 Single Groove Crankshaft Pulley - LWP Lower. -0.15  
..... **\$39.50 EA** ⚠



**R9608** .....ALL  
Chrome SB Chevy 283-350 V8 Triple Groove Crankshaft Pulley - LWP Lower. -0.15  
..... **\$46.00 EA** ⚠

## Crankshaft Pulley (RPC) Chevy BB, Polished Aluminum

Crankshaft pulleys for BB Chevy 396-454.



**R8841POL** .....ALL  
Polished Aluminum BB Chevy V8 Single Groove Pulley - SWP Lower. -0.15  
..... **\$43.25 EA** ⚠



**R8849POL** .....ALL  
Polished Aluminum BB Chevy V8 Triple Groove Pulley - SWP Lower. -0.15  
..... **\$70.59 EA** ⚠

**Crankshaft Pulley (RPC) Chevy BB, Satin Aluminum**



**R8845**.....**ALL**  
 Satin Aluminum BB Chevy 1969-up Triple Groove Crankshaft Pulley - LWP  
 Lower. -0.15 ..... **\$85.00 EA** ⚠

**Crankshaft Pulley (RPC) Chevy BB, Chrome**



**R9724**.....**ALL**  
 Chrome BB Chevy 396-454 V8 Triple Groove Crankshaft Pulley - LWP  
 Lower. -0.15 ..... **\$44.50 EA** ⚠

**Crankshaft Pulley (RPC) Ford SB, Chrome**



**R8971**.....**ALL**  
 Chrome Ford 1965-66 289 Single Groove Pulley - Lower. -0.15 ..... **\$34.79 EA** ⚠

**AC Systems Perfect Fit Chevy Cars**

Perfect Fit air conditioners use your original GM heater controls and provide you with powerful air conditioning out of the dash louvers, heat on the floor, and dehumidified defrost.

Designed for your specific year and model GM. The GM air conditioning features a flat firewall for a clean look, Air conditioning louvers are in-dash. Installed system gives you dash a/c, heat on the floor, and dehumidified defrost. Stock heater control panel is utilized. Our GM Air conditioning compressor features Hi/Low pressure switch for compressor protection. Installation is a breeze!

Each Perfect Fit air conditioning kit comes standard with the components you need to RETROFIT your classic GM. You'll be living with cool comfort featuring the latest air conditioning technology built into the best-designed climate control system on the market today.

What makes our GM air-conditioning Perfect Fit kit the market leader? High performance. Every single AC component is chosen based on its superior design and overall quality rather than a low cost.

A smaller A/C system is never better when it comes to cooling a high-powered, classic GM.

Choose your specific model below to see what you can expect in your GM Perfect Fit air conditioning kit.



- CAA20215** ..... **55-56**  
 1955-56 Chevy Bel Air Perfect Fit A/C System -0 ..... **\$1,379.00 EA** ⚠
- CAA20216** ..... **57**  
 1957 Chevy Bel Air Perfect Fit A/C System -0 ..... **\$1,379.00 EA** ⚠
- CAA20226** ..... **58**  
 1958 Chevy Impala Perfect Fit A/C System -0 ..... **\$1,379.00 EA** ⚠
- CAA20254** ..... **58-62**  
 1958-62 Chevy Corvette Perfect Fit A/C System -0 ..... **\$1,379.00 EA** ⚠

**AC Systems Perfect Fit Chevy Cars, cont.**

- CAA20227** ..... **59-60**  
 1959-60 Chevy Impala Perfect Fit A/C System -0 ..... **\$1,379.00 EA** ⚠
- CAA20219** ..... **61-62**  
 1961-62 Chevy Sedan / Impala Perfect Fit A/C System -0 ..... **\$1,379.00 EA** ⚠
- CAA20229** ..... **63**  
 63 Chevy Sedan / Impala Perfect Fit A/C System -0 ..... **\$1,449.00 EA** ⚠
- CAA20230** ..... **64**  
 1964 Chevy Sedan / Impala Perfect Fit A/C System -0 ..... **\$1,379.00 EA** ⚠



**WARNING: Cancer and Reproductive Harm —**  
[www.P65Warnings.ca.gov](http://www.P65Warnings.ca.gov)

NOTE: Any chemicals will be shipped domestic ground only (Lower 48 states only). No international shipping.



**AC Systems Perfect Fit Chevy Trucks**

Perfect Fit air conditioners use your original GM heater controls and provide you with powerful air conditioning out of the dash louvers, heat on the floor, and dehumidified defrost.

Designed for your specific year and model GM. The GM air conditioning features a flat firewall for a clean look, Air conditioning louvers are in-dash. Installed system gives you dash a/c, heat on the floor, and dehumidified defrost. Stock heater control panel is utilized. Our GM Air conditioning compressor features Hi/Low pressure switch for compressor protection. Installation is a breeze!

Each Perfect Fit air conditioning kit comes standard with the components you need to RETROFIT your classic GM. You'll be living with cool comfort featuring the latest air conditioning technology built into the best-designed climate control system on the market today.

What makes our GM air-conditioning Perfect Fit kit the market leader? High performance. Every single AC component is chosen based on its superior design and overall quality rather than a low cost.

A smaller A/C system is never better when it comes to cooling a high-powered, classic GM.

Choose your specific model below to see what you can expect in your GM Perfect Fit air conditioning kit.



- CAA20207** .....55-59  
1955-59 Chevy Pickup Perfect Fit A/C System -0 ..... **\$1,379.00 EA** ⚠
- CAA20208** .....60-63  
1960-63 Chevy Pickup Perfect Fit A/C System -0 ..... **\$1,379.00 EA** ⚠

**AC Systems Perfect Fit Ford Cars**

The Ford Perfect Fit air conditioning system is designed specifically to bolt into your Ford with minimum modification to your vehicle. In some Ford installations, only one hole needs to be drilled into your car.

Perfect Fit air conditioners use your original Ford heater controls and provide you with powerful air conditioning out of the dash louvers, heat on the floor, and dehumidified defrost.

Designed for your specific year and model Ford. The Ford air conditioning features a flat firewall for a clean look, Air conditioning louvers are in-dash. Installed system gives you dash a/c, heat on the floor, and dehumidified defrost. Stock heater control panel is utilized. Our Ford Air conditioning compressor features Hi/Low pressure switch for compressor protection. Installation is a breeze!

Each Perfect Fit air conditioning kit comes standard with the components you need to RETROFIT your classic Ford. You'll be living with cool comfort featuring the latest air conditioning technology built into the best-designed climate control system on the market today.

What makes our Ford air-conditioning Perfect Fit kit the market leader? High performance. Every single AC component is chosen based on its superior design and overall quality rather than a low cost.

A smaller A/C system is never better when it comes to cooling a high-powered, classic Ford.

Choose your specific model below to see what you can expect in your Ford Perfect Fit air conditioning kit.

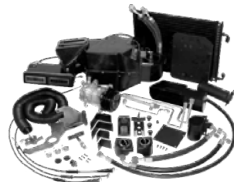

- CAA20282** .....55-56  
1955-56 Ford Fairlane Perfect Fit A/C System -0 ..... **\$1,448.99 EA** ⚠
- CAA20278** .....55-57  
1955-57 Ford Thunderbird Perfect Fit A/C System -0 ..... **\$1,574.00 EA** ⚠

**AC Systems Perfect Fit Ford Cars, cont.**

- CAA20294** .....58-60  
1958-60 Ford Thunderbird Perfect Fit A/C System -0 ..... **\$1,379.00 EA** ⚠
- CAA20279** .....61-63  
1961-63 Ford Thunderbird Perfect Fit A/C System -0 ..... **\$1,379.00 EA** ⚠
- CAA20295** .....63-64  
1963-64 Ford Galaxie Perfect Fit A/C System -0 ..... **\$1,379.00 EA** ⚠

**AC Systems Perfect Fit Ford Trucks**

The Ford Perfect Fit air conditioning system is designed specifically to bolt into your Ford with minimum modification to your vehicle. In some Ford installations, only one hole needs to be drilled into your car.

Perfect Fit air conditioners use your original Ford heater controls and provide you with powerful air conditioning out of the dash louvers, heat on the floor, and dehumidified defrost.

Designed for your specific year and model Ford. The Ford air conditioning features a flat firewall for a clean look, Air conditioning louvers are in-dash. Installed system gives you dash a/c, heat on the floor, and dehumidified defrost. Stock heater control panel is utilized. Our Ford Air conditioning compressor features Hi/Low pressure switch for compressor protection. Installation is a breeze!

Each Perfect Fit air conditioning kit comes standard with the components you need to RETROFIT your classic Ford. You'll be living with cool comfort featuring the latest air conditioning technology built into the best-designed climate control system on the market today.

What makes our Ford air-conditioning Perfect Fit kit the market leader? High performance. Every single AC component is chosen based on its superior design and overall quality rather than a low cost.

A smaller A/C system is never better when it comes to cooling a high-powered, classic Ford.

Choose your specific model below to see what you can expect in your Ford Perfect Fit air conditioning kit.



**AC Systems Perfect Fit Ford Trucks**



- CAA20193** .....48-52  
1948-52 Ford Pickup Perfect Fit A/C System -0 ..... **\$1,379.00 EA** ⚠
- CAA20194** .....53-56  
1953-56 Ford Pickup Perfect Fit A/C System -0 ..... **\$1,379.00 EA** ⚠
- CAA20195** .....57-60  
1957-60 Ford Pickup Perfect Fit A/C System -0 ..... **\$1,379.00 EA** ⚠
- CAA20196** .....61-64  
1961-64 Ford Pickup Perfect Fit A/C System -0 ..... **\$1,379.00 EA** ⚠

**Old Air Air Conditioning & Heating System**

Complete Universal systems with everything you need to install Heat & Air Conditioning in your vehicle (minus refrigerant). These Hurricane units are designed for efficiency and minimal use of space to allow for stereos, glove boxes, wiper motors, etc. Choose Hurricane unit with Upper, Lower or Side exit fittings (see dimensions below). System includes Sanden 508 Compressor (or equivalent), mounting brackets, Condenser (you'll need to measure your radiator), Receiver/ Drier, Binary Pressure Safety Switch, A/C & Heater Hose, Wire Harness, Clamps, 4 inch Vent Hose Kit, Control Panel w/ Knobs and more. Pick 4 vents to best suit your dash (some double vents count as 2). Optional items include Electronic Slide Controls (Vertical or Horizontal) in black or aluminum finish, Chrome Drier or Polished Compressor. Condensers use flat tubes not round creating greater frontal area which equates to improved cooling.

The Heat & Defrost units for these systems mounts directly to your firewall. A/C & Heater lines pass through a custom rubber grommet that fits into the factory blower motor hole. Take a look at our In-Dash Vent and Switch kit below. These systems are designed for easy installation with custom condenser mounting, aluminum lines and step-by-step instructions. Retains cowl vent and majority of glove box. Has floor Heat and De-Humidified Defrost.

**Old Air Air Conditioning & Heating System, cont.**

- AC1000C** ..... **ALL**  
Complete System with Upper HVAC fittings and Cable Controls. 9.779 -0.15  
..... **\$1,119.00 SET** ⚠
- AC1100C** ..... **ALL**  
Complete System with Upper HVAC fittings and Electronic Controls. 9.779 -0.15  
..... **\$1,219.00 SET** ⚠
- AC2000C** ..... **ALL**  
Complete System with 90-degree HVAC fittings and Cable Controls. 9.779 -0.15  
..... **\$1,120.00 SET** ⚠
- AC2100C** ..... **ALL**  
Complete System with right side HVAC fittings and Electronic Controls. 9.779 -0.15  
..... **\$1,219.00 SET** ⚠
- AC3000C** ..... **ALL**  
Complete System with Lower HVAC fittings and Cable Controls. 9.779 -0.15  
..... **\$1,120.00 SET** ⚠
- AC3100C** ..... **ALL**  
Complete System with Lower HVAC fittings and Electronic Controls. 9.779 -0.15  
..... **\$1,220.00 SET** ⚠

**Hidden Controls A/C System**

Go into stealth mode for your 47-53 Chevy Truck. Kit hides center vents and controls behind stock speaker grill. Order as a complete system or choose interior only kit. Choose 2 additional vents (vent choices on following pages).  
For stock 47-53 Chevy/ GMC Truck speaker grilles for above A/C controls & hidden vents see section 360.

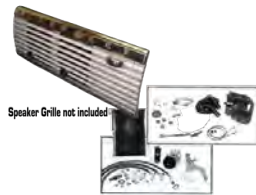

- AC4000GC** .....47-53  
Complete system. Cable operated controls. Choose 2 additional vents. 9.779 -0.15  
..... **\$1,350.00 SET** ⚠
- AC4000GI** .....47-53  
Interior only system. Cable operated controls. Choose 2 additional vents (no A/C items forward of firewall: compressor, dryer, etc). 9.779 -0.15  
..... **\$720.00 SET** ⚠

**Under Dash A/C System**

Custom Heat Cool & Defrost system for 1947-early 1955 Chevrolet and GMC trucks with compressor mounted on driver side of engine. Custom mounting plate attaches the Hurricane unit to firewall using original heater mounting holes. The A/C & Heater fittings pass through the original factory blower motor hole with a custom rubber grommet. Compact design allows you to retain the cowl vent and a majority of the glove box.

Custom Molded Plenum fits along bottom edge of the dash. Plenum includes rectangular louvers, rotary blower switch, thermostat and two push/pull cables to operate heater and defrost functions. An additional underdash louver is also included to for the left side of the steering column. If desired the plenum can be painted or covered with upholstery to match the interior of of the truck.

Complete System includes a rotary compressor, mounting bracket and condenser/drier assembly with custom tubes for a driver side mounted compressor. A variety of compressor and mounting brackets are available to fit most popular Chevrolet V8 & 6 cylinder engines. The AC hose kit is made with barrier style hose and o-ring style fittings.



- AC4000DC** .....47-54  
Cable operated controls. 9.779 -0.15  
..... **\$1,350.50 SET** ⚠



- AC4100DC** .....47-54  
Complete system. Mounts under dash. Electronic Controls. 9.779 -0.15  
..... **\$1,450.50 SET** ⚠



**WARNING: Cancer and Reproductive Harm —**  
www.P65Warnings.ca.gov

NOTE: Any chemicals will be shipped domestic ground only (Lower 48 states only). No international shipping.

**(800) 952-1752 • www.streetrodhq.com**

**Old Air Air Conditioning & Heating System Upgrades**

OPTIONS: We offer Horizontal or Vertical Slide Controls. Your choice of Brushed Aluminum or Black finish. You can also shine up your engine bay with a Polished Compressor and Chrome Drier (with polished clamp). All for a very reasonable cost.



**ACDRIERUP . . . . .ALL**  
 Chrome drier for air conditioning. With polished mounting bracket. 8" L x 2-1/2" dia. With sight glass. 9.779-0.15  
 . . . . . **\$78.00 EA** ⚠️



**ACDVENT . . . . .ALL**  
 Defroster vent. Replaces missing or worn vents. Plastic. 9.779-0.15 . . . **\$18.50 EA** ⚠️



**ACPNL-E . . . . .ALL**  
 Electronic controls. Smooth servo action. Available in Horizontal or Vertical cover plate and Brushed Aluminum or Black finish. 9.779-0 . . . starting at **\$85.00 EA** ⚠️



**ACPNL-EHA . . . . .ALL**  
 Electronic Controls. Horizontal, brushed aluminum. 9.779-0 . . . **\$165.00 EA** ⚠️



**ACPNL-EHB . . . . .ALL**  
 Electronic Controls. Horizontal, black. 9.779-0 . . . . . **\$165.00 EA** ⚠️

**Old Air Air Conditioning & Heating System Upgrades, cont.**



**ACPNL-EVA . . . . .ALL**  
 Electronic Controls. Vertical, brushed aluminum. 9.779-0  
 . . . . . **\$165.00 EA** ⚠️



**ACPNL-EVB . . . . .ALL**  
 Electronic Controls. Vertical, black. 9.779-0  
 . . . . . **\$165.00 EA** ⚠️



**ACTRINARY . . . . .ALL**  
 In-line Trinary Pressure Switch. 9.779-0.15  
 . . . . . **\$19.99 EA** ⚠️

**Universal Heater & Defroster by Vintage Air**



**506101 . . . . .ALL**  
 GEN II COMPAC heater / defroster with electronic servo controls & 3 speed fan. 9.779-0.15 . . . . . **\$260.25 KIT** ⚠️

**Universal Heater by Vintage Air**



**50515-VUH . . . . .ALL**  
 GEN II COMPAC heater only with electronic servo controls & 3 speed fan. 9.779-0.15  
 . . . . . **\$195.00 EA** ⚠️

**Old Air Air Conditioning & Heating System Vents**



**VENT-1 . . . . .ALL**  
 HVAC vent under dash, rectangular (2" x 6-1/4"). 9.779-0.15 . . . **\$14.50 EA** ⚠️



**VENT-10 . . . . .ALL**  
 HVAC vents under dash, round corner. 9.779-0.15 . . . . . **\$34.50 PR** ⚠️



**VENT-14 . . . . .ALL**  
 HVAC vents kick panel louvers (pair). 9.779-0.15 . . . . . **\$34.50 EA** ⚠️



**VENT-2 . . . . .ALL**  
 HVAC vents under dash, round (3" x 4-1/2"). 9.779-0.15 . . . **\$14.50 EA** ⚠️



**VENT-20 . . . . .ALL**  
 HVAC vents under dash, rectangular double vent (2" x 10" ), Counts as 2. 9.779-0.15 . . . . . **\$26.00 EA** ⚠️



**Old Air Air Conditioning & Heating System Vents, cont.**



**VENT-21** .....ALL  
HVAC vents in dash, rectangular (3-1/2" x 3-1/2"). 9.779-0.15 . \$17.50 EA ⚠

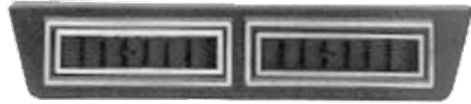

**VENT-3** .....ALL  
HVAC vents under dash, rectangular double vent (2" x 11-1/2"). Counts as 2. 9.779-0.15 ..... \$26.25 EA ⚠



**VENT-5** .....ALL  
HVAC vents in dash, rectangular (1-3/8" x 4-3/4"). 9.779-0.15 . \$14.00 EA ⚠

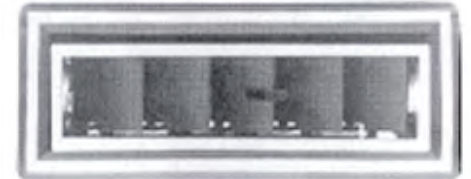

**VENT-6** .....ALL  
HVAC vents in dash, rectangular (1-3/8" x 3-3/4"). 9.779-0.15 . \$14.00 EA ⚠



**VENT-7** .....ALL  
HVAC vents in dash, rectangular (2-3/4" x 2-1/2"). 9.779-0.15 . \$14.00 EA ⚠

**Old Air Air Conditioning & Heating System Vents, cont.**

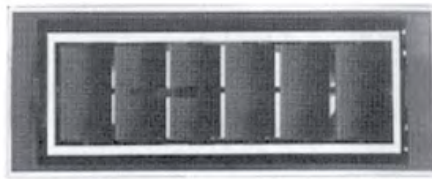

**VENT-8** .....ALL  
HVAC vents in dash, rectangular (2" x 5-1/4"). 9.779-0.15 . \$14.00 EA ⚠



**VENT-9** .....ALL  
HVAC vents in dash, round (2-1/4" diameter). 9.779-0.15 .. \$14.00 EA ⚠

**Vent Heat Or AC Billet Specialties**



**BIS38110** .....ALL  
Billet Bezel with Plastic louvers. Dimensions  
Dash Opening: 2-1/2"  
Hose Size: 2-1/2"  
Outer Bezel: 2-3/4"  
Mounting Depth: 1-7/8" -0  
..... \$24.25 EA ⚠



**BIS38220** .....ALL  
Silhouette. Dimensions  
Dash Opening: 2-1/2"  
Hose Size: 2-1/2"  
Outer Bezel: 2-3/4"  
Mounting Depth: 1-7/8" -0  
..... \$41.89 EA ⚠

**Vent Heat Or AC Billet Specialties, cont.**



**BIS38320** .....ALL  
Slotted. Dimensions  
Dash Opening: 2-1/2"  
Hose Size: 2-1/2"  
Outer Bezel: 2-3/4"  
Mounting Depth: 1-7/8" -0.15  
..... \$46.50 EA ⚠

**Custom Dash Vents**

**BWAC** ..... ALL  
Vertical design. -0.15 ... \$42.99 EA ⚠



**BWAC2** .....ALL  
Wave design. -0.15 . \$39.59 EA ⚠



**CMW-AC902** .....ALL  
Chrome. Elliptical 4" x 1.6" modular design. Includes mounting hardware & template. -0.15 ..... \$99.25 EA ⚠

**Air Conditioning Compressors**

**OAP21-6629** ..... ALL  
Sanden for R-134A compressor. Vertical o-ring, serpentine belt pulley-clutch. 9.170-0.15 ..... \$195.00 EA ⚠

**OAP21-9537** ..... ALL  
Sanden for R-12 compressor. Vertical o-ring, serpentine belt pulley-clutch. 9.170-0.15 ..... \$195.00 EA ⚠

**OAP21-9537P** ..... ALL  
Polished Sanden for R-12 compressor. Vertical o-ring, serpentine belt pulley-clutch. 9.170-0.15 ..... \$225.00 EA ⚠

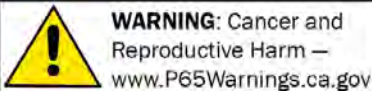

NOTE: Any chemicals will be shipped domestic ground only (Lower 48 states only). No international shipping.

**Billet A/C Compressor Brackets**



**BIS10221**.....**ALL**  
Short water pump, Chevy SB, top mount compressor. Use for Sanden 508 compressor only (Passenger side mount). 3 point mounting to head & water pump for stability. Stainless hardware included. 9.171 -0.15 ..... **\$135.00 EA** ⚠

**Air Conditioning Bracket**



**R9513**.....**ALL**  
Chrome Pre-1977 SB Chevy 283-350 V8 Air Conditioning Bracket. -0.15 ..... **\$7.19 EA** ⚠

**Compressor Pulley Covers**



**R8850**.....**ALL**  
Satin Billet Aluminum Air Condition Clutch Cover for Sanden #508 Compressor. -0.15 ..... **\$19.59 EA** ⚠



**R8850POL**.....**ALL**  
Polished Billet Aluminum Air Condition Clutch Cover for Sanden #508 Compressor. -0.15 ..... **\$26.00 EA** ⚠

**Fan**



**40848**.....**ALL**  
12 volt 6" steel blade head-duty fan. -0.15 ..... **\$31.50 EA** ⚠

**Heater Control Valve**



**OAP50-1555**.....**ALL**  
This heater control valve or electronic bypass valve controls water flow to heater from minimal to full flow. Easy installation. Uses high-torque servo motor. Non corrosive, safe water flow control for a variety of applications. Heater valve fits 5/8" heater hose, with sleeve adapters for 3/4" heater hose applications. Made in the USA! 9.795 -0.15 .. **\$115.25 EA** ⚠

**Heater Hose Kits**



**GOT343200**.....**ALL**  
S.S. Heater hose kit includes (2) #10 90° electro-polished, (2) -8 female AN straight fittings, (1) 90° 1/2" NPT x -8 male AN and (1) straight 1/2" NPT x -8 male AN adapter. -0.15 ..... **\$223.75 SET** ⚠



**GOT343300**.....**ALL**  
Same as 343200 - fits Edelbrock manifold (3/8" NPT Fitting). -0.15 ..... **\$223.75 SET** ⚠

**Heater Hose Kits, cont.**



**R7313**.....**ALL**  
Chrome 44" Stainless Steel "Heater" Hose Kit with Polished Aluminum Caps. -0.15 ..... **\$76.49 EA** ⚠



**UHH48**.....**ALL**  
Ultra hose kit. 2 hoses (48in. each) and 4 hose ends. 8.846 -0.15 ..... **\$99.00 SET** ⚠

**Hose Clamps Thermal**

These heat-sensitive bands shrink to conform to any shape of hose and housing when heat is applied (even out-of-round fittings). Automatically readjusts every time the engine comes to operating temperature. After the engine is shut down, temperatures decrease and the clamp strengthens. Use a heat gun to secure clamps on and a soldering gun for removal. For larger radiator hose clamps see section 30.



**CLAMP1**.....**ALL**  
1/2" I.D. (13/16" to 15/16" O.D.) hose. Solve leakage problems, even with out-of-round fittings. 1.166 -0.2 ..... **\$6.00 EA** ⚠

**CLAMP2**.....**ALL**  
5/8" I.D. (15/16" to 1-1/16" O.D.) hose. Solve leakage problems, even with out-of-round fittings. 1.166 -0.4 ..... **\$10.39 EA** ⚠

**Heater Hose Clamps (Billet Specialties)**

Machined from billet aluminum with a polished finish these clamps fit Braided or Rubber heater hose.



- BIS67425**.....ALL  
For 5/8" rubber heater hose. Machined from billet aluminum with a polished finish. 1.166 -0.15 ..... **\$14.00 EA** ⚠
- BIS67525**.....ALL  
For 5/8" braided heater hose. Machined from billet aluminum with a polished finish. 1.166 -0.15 ..... **\$14.00 EA** ⚠
- BIS67625**.....ALL  
For 3/4" rubber heater hose. Machined from billet aluminum with a polished finish. 1.166 -0.15 ..... **\$14.00 EA** ⚠
- BIS67725**.....ALL  
For 3/4" braided heater hose. Machined from billet aluminum with a polished finish. 1.166 -0.15 ..... **\$14.00 EA** ⚠

**Hose Separators Billet Specialties**



- BIS68020**.....ALL  
.440 x .540 polished aluminum. 8.950 -0.15 ..... **\$14.00 EA** ⚠
- BIS68025**.....ALL  
.440 x .630 polished aluminum. 8.950 -0.15 ..... **\$14.00 EA** ⚠
- BIS68120**.....ALL  
.500 x .500 polished aluminum. 8.950 -0 ..... **\$12.99 EA** ⚠
- BIS68125**.....ALL  
.540 x .630 polished aluminum. 8.950 -0.15 ..... **\$14.00 EA** ⚠
- BIS68220**.....ALL  
.562 x .562 polished aluminum. 8.950 -0 ..... **\$12.99 EA** ⚠
- BIS68225**.....ALL  
.562 x .625 polished aluminum. 8.950 -0.15 ..... **\$14.00 EA** ⚠
- BIS68320**.....ALL  
.625 x .625 polished aluminum. 8.950 -0.15 ..... **\$14.00 EA** ⚠
- BIS68325**.....ALL  
.625 x .781 polished aluminum. 8.950 -0 ..... **\$12.99 EA** ⚠

**Hose Separators Billet Specialties, cont.**

- BIS68420**.....ALL  
.734 x .890 polished aluminum. 8.950 -0 ..... **\$12.99 EA** ⚠
- BIS68425**.....ALL  
.734 x .969 polished aluminum. 8.950 -0 ..... **\$12.99 EA** ⚠
- BIS68520**.....ALL  
.781 x .781 polished aluminum. 8.950 -0 ..... **\$12.99 EA** ⚠
- BIS68525**.....ALL  
.781 x .906 polished aluminum. 8.950 -0.15 ..... **\$14.00 EA** ⚠
- BIS68625**.....ALL  
.890 x .969 polished aluminum. 8.950 -0.15 ..... **\$14.00 EA** ⚠
- BIS68720**.....ALL  
.906 x .906 polished aluminum. 8.950 -0 ..... **\$12.99 EA** ⚠
- BIS68725**.....ALL  
.906 x 1.015 polished aluminum. 8.950 -0.15 ..... **\$14.00 EA** ⚠
- BIS68729**.....ALL  
.906 x 1.125 polished aluminum. 8.950 -0.15 ..... **\$14.00 EA** ⚠
- BIS68820**.....ALL  
.906 x 1.125 polished aluminum. 8.950 -0 ..... **\$12.99 EA** ⚠

**Aluminum Bundle Straps**



- 13196**.....ALL  
.25" W X 4.05" L  
Used to bundle wires or hoses. -0.2 ..... **\$4.00 EA** ⚠



- 13197**.....ALL  
.25" W X 7.15" L  
Used to bundle wires or hoses -0.2 ..... **\$5.00 EA** ⚠

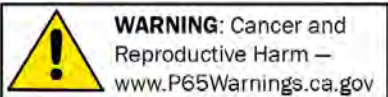

NOTE: Any chemicals will be shipped domestic ground only (Lower 48 states only). No international shipping.

**Section 040: Starters**

**Section 045: Alternators, Alternator Pulleys & Battery Connectors**

**Starters**



**R3910** .....**.ALL**  
Satin Aluminum GM SB Chevy & BB Chevy  
Gear Reduction Starter - 1.6 HP. -0.15  
..... **\$142.75 EA** ⚠



**R3910C** .....**.ALL**  
Chrome Aluminum GM SB Chevy & BB  
Chevy Gear Reduction Starter - 1.6  
HP. -0.15 ..... **\$164.25 EA** ⚠

**Starter Heat Shield**



**R6077** .....**.ALL**  
Satin Aluminum Starter Heat Shield - Fits  
Most GM Starters. Note: Not for 6  
cyl. -0.15 ..... **\$18.09 EA** ⚠

**Battery Mat**



**3686708B** .....**.ALL**  
Anti-corrosion pad to protect your battery  
tray. 7 3/4" X 12" x 1/8" thick. 2.333 -0.3  
..... **\$15.25 EA** ⚠

**Battery Tray With Hold Down**



**R6323** .....**.ALL**  
Polished Aluminum "Optima" Battery  
Mount, Ball milled. -0.15 .. **\$85.19 EA**  
⚠



**R9323** .....**.ALL**  
Stainless Steel Battery Tray (Includes Hold  
Downs).  
7-1/2" x 13-1/4" -0.15 ..... **\$40.75 EA** ⚠

**Battery Minder Plus Battery  
Charger**

The Battery minder plus is a 3-mode charger/  
maintainer/conditioner that extends  
performance and life of all types and sizes  
of 6 or 12 volt lead acid batteries (Choose  
either 6 or 12 volt charger). These include  
maintenance-free, marine, deep cycle, sealed,  
gel, and all popular brands of AGM dry-type,  
valve-regulated batteries, such as those made  
by Interstate, Exide, Optima and Odyssey.

The Battery minder Plus automatically  
dissolves harmful power-robbing sulphation  
using safe, U.S. patented high-frequency  
pulse technology. Guaranteed to significantly  
increase your batteries life and performance.

1.33 amps = maximum charging current when  
battery is fully discharged.

(1.0 amp = maximum current available  
if required by battery when unit is in  
maintenance mode)

Sulphation is the #1 cause of early battery  
failure and loss of performance as determined  
by the battery council international, Dec.  
1998.



**BM06V** .....**.ALL**  
6 Volt Charger. 2.332 -0.15 ..... **\$60.00 EA**  
⚠

**Electric Battery Disconnect Anti-Theft**

Electric Battery Disconnects. Great as anti-theft deterrents or to prevent battery drain. Each includes auxiliary "hot" feed to the clock or computer or other items requiring power for memory. Hardware, wire, connectors and detailed instructions included. There is no electricity used when these units are on or off, only while switching.



**WASL27TM** .....ALL  
Theft deterrent made simple. Toggle battery disconnect mounts inside vehicle. Push it once to disconnect excluding hot feed for clocks, radios, etc. Rated 85 amps continuous & 750 amp surge. Includes hardware, wire, connectors and detailed instructions. -0.15 ... **\$129.00 EA** ⚠

**Battery Disconnect**

Rotating knob provides effortless way of disconnecting negative battery terminal. Great for cars driven only on Sundays to the grocery store to help maintain battery life.



**20019A** .....ALL  
Battery disconnect switch for top post battery for disconnecting negative battery terminal. 2.345-0.15 .... **\$22.00 EA** ⚠



**20019B** .....ALL  
Battery disconnect switch for side post battery for disconnecting negative battery terminal. 2.345-0.2 .... **\$26.25 EA** ⚠

**Battery Terminal Cleaner**

**10653CLNR** ...ALL  
For Top Post Batteries. -0.15  
..... **\$9.25 EA** ⚠



**12 Volt Conversion Kits**



**12VKIT01** .....37-54  
Includes 63 amp alternator with 5/8" pulley, bracket & hardware, 10 AWG charge wire, coil, horn relay, headlight relay, fuel gauge voltage reducer, instructions. -0.15 ..... **\$375.75 EA** ⚠

**12VKIT02** .....37-54  
Includes 63 amp alternator with 3/8" pulley, bracket & hardware, 10 AWG charge wire, coil, horn relay, headlight relay, fuel gauge voltage reducer, instructions. -0.15 ..... **\$375.59 EA** ⚠

**12VKIT03** .....37-54  
Includes 100 amp alternator with 5/8" pulley, bracket & hardware, 10 AWG charge wire, coil, horn relay, headlight relay, fuel gauge voltage reducer, instructions. -0.15 ..... **\$400.25 EA** ⚠

**12VKIT04** .....37-54  
Includes 100 amp alternator with 3/8" pulley, bracket & hardware, 10 AWG charge wire, coil, horn relay, headlight relay, fuel gauge voltage reducer, instructions. -0.15 ..... **\$400.25 EA** ⚠

**12VKIT05** .....37-54  
Includes 63 amp alternator with 5/8" pulley, bracket & hardware, 10 AWG charge wire, coil, starter solenoid, horn relay, headlight relay, fuel gauge voltage reducer, instructions. -0.15 .. **\$426.25 EA** ⚠

**12VKIT06** .....37-54  
Includes 63 amp alternator with 3/8" pulley, bracket & hardware, 10 AWG charge wire, coil, starter solenoid, horn relay, headlight relay, fuel gauge voltage reducer, instructions. -0.15 .. **\$426.25 EA** ⚠

**12VKIT07** .....37-54  
Includes 100 amp alternator with 5/8" pulley, bracket & hardware, 10 AWG charge wire, coil, starter solenoid, horn relay, headlight relay, fuel gauge voltage reducer, instructions. -0.15 .. **\$449.50 EA** ⚠

**12VKIT08** .....37-54  
Includes 100 amp alternator with 3/8" pulley, bracket & hardware, 10 AWG charge wire, coil, starter solenoid, horn relay, headlight relay, fuel gauge voltage reducer, instructions. -0.15 .. **\$451.00 EA** ⚠

**Alternators**



**82021**.....48-53  
Powermaster-PowerGen Ford Flathead W/ Strap Mount 49-53 (90A,12V) Black -0.15  
..... **\$379.00 EA** ⚠

**17078** ..... ALL  
Alternator-Ford Chrome 1G 65A -0.15  
..... **\$140.09 EA** ⚠

**17294**..... ALL  
Alternator-GM Chrome 100A 1-3  
Wire -0.15 ..... **\$142.00 EA** ⚠

**37293**..... ALL  
Alternator-GM Chrome 150A 1-3  
Wire -0.15 ..... **\$182.00 EA** ⚠



**82051**.....ALL  
Powermaster-PowerGen GM Long (90A,12V) Black -0.15 . **\$419.00 EA** ⚠



**82056**.....ALL  
Powermaster-PowerGen GM Long (60A, 6V + Ground) Black -0.15 . **\$429.00 EA** ⚠



**82057**.....ALL  
Powermaster-PowerGen GM Long (60A,6V Neg Ground) Black -0.15 .. **\$429.00 EA** ⚠

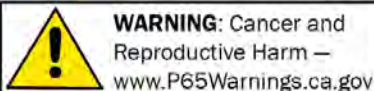

NOTE: Any chemicals will be shipped domestic ground only (Lower 48 states only). No international shipping.



**Alternators, cont.**



**82111**.....ALL  
Powermaster-PowerGen GM Short (90A,12v)  
Black -0.15 ..... **\$419.00 EA** ⚠



**82116**.....ALL  
Powermaster-PowerGen GM Short (60A,6V  
+ Ground) Black -0.15 ..... **\$429.00 EA** ⚠



**82117**.....ALL  
Powermaster-PowerGen GM Short (60A,6V  
Neg Ground ) Black -0.15 ..... **\$429.00 EA** ⚠



**89502C**.....ALL  
6v-60 amp, 7.5v show chrome housing,  
3/8" 2 groove pulley, internally regulated,  
comes w/ D.A. plug, uses original wiring,  
new. 2.275 -0 ..... **\$296.50 EA** ⚠



**89502S**.....ALL  
6v-60 amp, 7.5v internally regulated,  
single groove 3/8" pulley.†(Rebuilt) 2.275 -0  
..... **\$222.25 EA** ⚠

**Alternators, cont.**



**905021**.....ALL  
10SI 12v, 63 Amp Internally Regulated  
With 3/8 "Pulley -0.15 ..... **\$180.25 EA** ⚠



**905022**.....ALL  
CS130 12v, 100 Amp Internally Regulated  
With 3/8 "Pulley -0.15 ..... **\$195.50 EA** ⚠



**905023**.....ALL  
10SI 12v,Chrome Internally Regulated  
1-Wire With 3/8 "Pulley -0.15  
..... **\$170.25 EA** ⚠



**905024**.....ALL  
10SI 12v,Chrome Internally Regulated  
1-Wire With 5/8 "Pulley -0.15  
..... **\$194.49 EA** ⚠



**90502H0**.....ALL  
12v-100 amp, 14v internally regulated,  
simple two wire hookup, replace any  
12-volt generator, comes with D.A. plug  
new. 2.275 -0.15 ..... **\$140.00 EA** ⚠

**Alternators, cont.**



**90502S**.....ALL  
12v-60 amp, 14v internally regulated,  
simple two wire hookup, replace any 12v  
generator, comes with D.A. plug, new.  
2.275 -0 ..... **\$221.50 EA** ⚠



**R3902**.....ALL  
Chrome GM 1955-up Alternator, 100  
Amps (remanufactured). -0.15  
..... **\$197.25 EA** ⚠



**R3903**.....ALL  
Chrome FORD 1965-1989 Alternator  
(remanufactured). -0.15 ..... **\$194.00 EA** ⚠

**Alternator Housing Kit**



**R6679**.....ALL  
Chrome 1973-1985 GM Alternator  
Housing Kit with Pulley (Internal  
Regulator). -0.15 ..... **\$72.00 EA** ⚠

**Alternator Harness**



**ALT12**.....ALL  
Alternator Harness for GM 10SI -0.15  
..... **\$67.75** ⚠

**Alternator Harness, cont.**



**ALT14** .....ALL  
 Alternator Harness for One Wire -0.15  
 ..... \$57.75 ⚠



**ALT16** .....ALL  
 Alternator Harness for GM CS-130 -0.15  
 ..... \$72.75 ⚠



**ALT17** .....ALL  
 Alternator Harness for GM CS-144 -0.15  
 ..... \$72.75 ⚠



**ALT22** .....ALL  
 Alternator Harness for Ford 2G -0.15  
 ..... \$62.75 ⚠



**ALT23** .....ALL  
 Alternator Harness for Ford 3G -0.15  
 ..... \$72.75 ⚠



**ALT24** .....ALL  
 Alternator Harness for Ford 4G -0.15  
 ..... \$72.75 ⚠

**Alternator Harness, cont.**



**ALT26** .....ALL  
 Alternator Harness for Ford 6G -0.15  
 ..... \$72.75 ⚠

**D.A. Plug**



**89502** .....ALL  
 Connects 6v or 12v alternator to original  
 wiring. 2.275 -0.15 ..... \$19.75 EA ⚠

**Alternator Pulley With Fan**



**BIS85220** .....ALL  
 Billet aluminum pulley, fan and nose cover.  
 Made from solid billet aluminum for  
 strength and durability. 2.274 -0  
 ..... \$55.00 EA ⚠

**Alternator Pulleys**



**90502WP** .....37-52  
 Fits 5/8 in. belt. 2.274 -0.15 ..... \$30.00 EA  
 ⚠



**89502P** .....ALL  
 3/8" 2 groove. 2.274 -0.15 ... \$37.50 EA  
 ⚠

**PMM1130** .....ALL  
 3/8" Belt Single Groove Black -0  
 ..... \$35.00 EA ⚠

**Alternator Pulleys, cont.**



**PMM1130C** .....ALL  
 3/8" single groove Chrome pulley -0  
 ..... \$35.00 EA ⚠



**PMM1135** .....ALL  
 5/8" Belt Single Groove Black -0.15  
 ..... \$30.00 EA ⚠



**R8857** .....ALL  
 CNC Billet Aluminum Oldsmobile Single  
 Groove Alternator Pulley. -0.15  
 ..... \$32.00 EA ⚠



**R9446** .....ALL  
 Chrome GM & Ford Single Groove Pulley  
 and Fan. -0.15 ..... \$17.19 EA ⚠



**R9487** .....ALL  
 Satin Aluminum SB Chevy Single Groove  
 Alternator Pulley. -0.15 .. \$29.25 EA ⚠



**WARNING: Cancer and Reproductive Harm —**  
[www.P65Warnings.ca.gov](http://www.P65Warnings.ca.gov)

NOTE: Any chemicals will be shipped domestic ground only (Lower 48 states only). No international shipping.

**Alternator Pulleys, cont.**



**R9487POL** .....ALL  
Polished Aluminum SB Chevy Single Groove Alternator Pulley. -0.15  
..... **\$37.50 EA** ⚠

**Alternator Brackets (Billet Specialties) Chevy SB**



**BIS10220** .....ALL  
Short water pump, small block. Top mount alternator. Adjustable. For early or late model GM 60 to 80 amp (small or large case) alternators on drivers side. 2.277 -0.15  
..... **\$135.00 EA** ⚠



**BIS11220** .....ALL  
Long water pump, small block. Top mount alternator. Adjustable. For early or late model GM 60 to 80 amp (small or large case) alternators on drivers side. 2.277 -0.15  
..... **\$155.00 EA** ⚠



**BISFM0109PC** .....ALL  
Passenger Side top-mount. Long water pump. 2.277 -0.15  
..... **\$105.00 EA** ⚠

**Alternator Brackets Chevy SB**



**R6402** .....ALL  
Chrome Aluminum SB Chevy Alternator Bracket - Long Water Pump (Includes Hardware). -0.15  
..... **\$97.29 EA** ⚠



**R6405** .....ALL  
Chrome Aluminum SB Chevy Alternator Bracket - Short Water Pump (Includes Hardware). -0.15  
..... **\$172.89 EA** ⚠

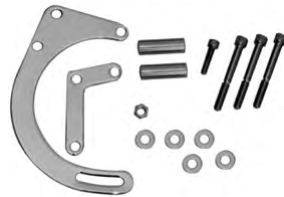

**R7758** .....ALL  
Chrome 1955-68 SB Chevy 283-350 Low Mount Alternator Bracket - Left Side. -0.15  
..... **\$32.50 EA** ⚠



**R9315** .....ALL  
Chrome 1965-68 SB Chevy 283-350 SWP Alternator Bracket - "OEM" Style. -0.15  
..... **\$18.25 EA** ⚠



**R9317** .....ALL  
Chrome 1976-86 SB Chevy 305-350 LWP Alternator Bracket - "OEM" Style. -0.15  
..... **\$16.50 EA** ⚠

**Alternator Brackets Chevy SB, cont.**



**R9319** .....ALL  
Chrome 1965-68 SB Chevy 283-350 SWP Alternator Bracket - "Custom" Style. -0.15  
..... **\$15.29 EA** ⚠



**R9637** .....ALL  
Chrome 1969-86 SB Chevy 305-350 LWP Bottom Alt Bracket - "Custom" Style. -0.15  
..... **\$6.45 EA** ⚠



**R9758** .....ALL  
Chrome 1955-68 SB Chevy 283-350 SWP Low Mount Alt Bracket - "Custom" Style. -0.15  
..... **\$28.00 EA** ⚠

**Alternator Brackets Chevy BB**



**R6408** .....ALL  
Chrome Aluminum BB Chevy Alternator Bracket - Long Water Pump (Includes Hardware). -0.15  
..... **\$100.50 EA** ⚠



**R6411** .....ALL  
Chrome Aluminum BB Chevy Alternator Bracket - Short Water Pump (Includes Hardware). -0.15  
..... **\$169.79 EA** ⚠

**Alternator Brackets Chevy 6 Cylinder**



**839446D** .....**37-55**  
 Alternator bracket. Mounting hardware included. 2.277 -0.2 ..... **\$73.75 KIT** ⚠



**3714376B** .....**55-62**  
 Alternator bracket (12v or 6v alt. 55-62 requires narrow pulley pump & 53-up crank pulley). Mounting hardware included. 2.277 -0.15 ..... **\$50.00 EA** ⚠

**Alternator Brackets Ford SB**



**R6414**.....**ALL**  
 Chrome Aluminum Ford 289-302 Alternator Bracket (Includes Hardware). -0.15 ..... **\$116.79 EA** ⚠



**R6417**.....**ALL**  
 Chrome Aluminum Ford 351 Windsor Alternator Bracket (Includes Hardware). -0.15 ..... **\$121.75 EA** ⚠

**Alternator Brackets Universal**



**839446B** .....**37-55**  
 Universal alternator bracket. 2.277 -0.15 ..... **\$89.75 EA** ⚠

**Alternator Brackets Universal, cont.**



**R9079**.....**ALL**  
 Chrome universal bracket arm. 1" wide x 14" long with 4" long slot. -0.15 ..... **\$10.06 EA** ⚠

045



**WARNING: Cancer and Reproductive Harm** —  
[www.P65Warnings.ca.gov](http://www.P65Warnings.ca.gov)

NOTE: Any chemicals will be shipped domestic ground only (Lower 48 states only). No international shipping.

**Timing Tabs**

Note: For timing tabs refer to section 22.

**Distributors**



**PED12720** .....ALL  
Chevy V8 HEI Distributor All small block  
and big block -0.15 ..... **\$279.00 EA** ⚠



**PED32820** .....ALL  
Ford V8 HEI Distributor  
351C-400M-429-460 cid -0.15  
..... **\$369.00 EA** ⚠



**PED33820** .....ALL  
Ford V8 HEI Distributor FE 352-360-361-  
390-427-428 cid -0.15 ..... **\$385.00 EA** ⚠



**PED35820** .....ALL  
Ford V8 HEI Distributor 351 cid  
Windsor -0.15 ..... **\$369.00 EA** ⚠



**PED38820** .....ALL  
Ford V8 HEI Distributor 302 w/ factory  
roller cam -0.15 ..... **\$399.00 EA** ⚠

**Distributors, cont.**



**PED39820** .....ALL  
Ford Inline 6 HEI Distributor 300 CID -0.15  
..... **\$369.00 EA** ⚠



**PED39820-200** .....ALL  
Ford Inline 6 HEI Distributor 170-200  
CID -0.15 ..... **\$389.00 EA** ⚠



**PED62720** .....ALL  
Chevy 6cyl 1949-62 216,235,261ci. DUI  
electronic Distributor 50,000 volt coil &  
Dyna-Module allows wider plug gaps &  
instant throttle response.  
Add a set of Livewires to go with your  
electronic distributor. 0.000 -0.15  
..... **\$394.00 EA** ⚠



**PED70820** .....ALL  
Dodge V8 HEI Distributor Small block  
318-318A Poly-340-360 cid. Black  
cap. -0.15 ..... **\$369.00 EA** ⚠



**PED70830** .....ALL  
Dodge V8 HEI Distributor Big block  
383-400 cid.† Black cap. -0.15  
..... **\$485.00 EA** ⚠

**Distributors, cont.**



**PED70930** .....ALL  
Dodge V8 HEI Distributor Big block  
426-440 cid. Black cap. -0.15  
..... **\$485.00 EA** ⚠



**R3925** .....ALL  
Chrome Aluminum Chevy HEI Electronic  
Distributor with 50K Coil - Red Cap. V8  
only. -0.15 ..... **\$86.89 EA** ⚠  
**R3926** .....ALL  
Chrome Aluminum Ford HEI Electronic  
Distributor with 50K Coil - Red Cap.  
289-302. -0.15 ..... **\$113.25 EA** ⚠

**Distributor Clamps**



**BIS65920** .....ALL  
Billet aluminum hold down clamp. Fits  
small or big block chevy motors. Polished.  
2.363-0 ..... **\$24.19 EA** ⚠



**R4116** .....ALL  
Chrome 1963-up Chevy V8 Distributor  
Clamp - OEM Style. -0.15 ..... **\$3.59 EA** ⚠



**R4455** .....ALL  
Chrome Ford Distributor Clamp - OEM  
Style. -0.15 ..... **\$3.00 EA** ⚠

**Vacuum Advance Covers**



**BIS88120 . . . . .ALL**  
 Billet aluminum cover. Polished. Simply applies with silicone. 3.75" diameter x 1.325" height. 2.410 -0.15

..... **\$16.69 EA** ⚠



**R4973 . . . . .ALL**

Chrome Vacuum Advance Cover. -0.15

..... **\$2.67 EA** ⚠

**Ignition Advance Kit**



**R4933 . . . . .ALL**

HEI Advance Curve Kit. -0.15

..... **\$4.25 EA** ⚠

**Pertronix Electronic Ignition System**

Delivers twice the voltage to the spark plugs, increasing horsepower, fuel economy, and spark plug life.

2:1 improvement over "points" in current fall time for increased coil output.

Rotating cobalt magnets trigger a Hall Effect integrated circuit, no points to burn, no moving parts to wear out.

Epoxy molding makes our module impervious to dirt, oil, grease and moisture.

Stable timing, no need for any adjustments.



**1112362E12 . . . . .40-53**

Chevy 6cyl. 12v. 2.384 -0.15

..... **\$137.00 SET** ⚠

**1112362E6 . . . . .40-53**

Chevy 6cyl. 6v. 2.384 -0.15

..... **\$149.75 SET** ⚠

**Pertronix Electronic Ignition System, cont.**

**1112388E12 . . . . .54-62**

Chevy 6cyl. 12v. 2.384 -0.15

..... **\$147.50 EA** ⚠

**1112388E6 . . . . .54-62**

Chevy 6cyl. 6v. 2.384 -0.15

..... **\$153.75 EA** ⚠

**Ignition Coil Pertronix**

PERTRONIX Flame Thrower 40,000 Volt Coil. Oil filled for better cooling and voltage insulation. Maximize energy and reliability over the full RPM range. 40,000 available volts. Enables larger plug gaps for greater fuel efficiency, more power and delivers an average of 15% more spark energy and voltage. Legal in all 50 states and Canada. Fits existing brackets. Made in U.S.A.



**PER40001 . . . . .ALL**

6 Volt Chrome. 1.5 Ohm primary resistance.

2.384 -0.15  
 ..... **\$47.00 EA** ⚠



**PER40011 . . . . .ALL**

6 Volt Black. 1.5 Ohm primary resistance.

2.384 -0.15  
 ..... **\$42.25 EA** ⚠



**PER40501 . . . . .ALL**

12 Volt Chrome. 3.0 Ohm primary resistance.

2.384 -0.15  
 ..... **\$47.00 EA** ⚠



**PER40511 . . . . .ALL**

12 Volt Black. 3.0 Ohm primary resistance.

2.384 -0.15  
 ..... **\$42.25 EA** ⚠

**Ignition Coil And Bracket**



**R9187 . . . . .ALL**

Chrome 40,000 Volt Coil & Bracket without Resistor. -0.15

..... **\$34.39 EA** ⚠



**R9203 . . . . .ALL**

Chrome 60,000 Volt Coil & Bracket with Resistor. -0.15

..... **\$41.50 EA** ⚠

**Ballast Resistor**



**1931614 . . . . .ALL**

For 12v (coil). 2.173 -0.2

..... **\$13.00 EA** ⚠

**Coil Covers And Brackets**



SHOWN WITH COIL (NOT INCLUDED)

**OTB-6831 . . . . .ALL**

Finned polished aluminum with mounting hardware (coil not included). -0.15

..... **\$75.25 EA** ⚠



**R9006 . . . . .ALL**

Chrome Universal Coil Cover & Bracket. -0.15

..... **\$5.75 EA** ⚠



**R9366 . . . . .ALL**

Chrome GM Type Stand-Up Coil Holder. -0.15

..... **\$4.50 EA** ⚠



**WARNING: Cancer and Reproductive Harm —**  
[www.P65Warnings.ca.gov](http://www.P65Warnings.ca.gov)

NOTE: Any chemicals will be shipped domestic ground only (Lower 48 states only). No international shipping.

**Coil Covers And Brackets, cont.**



**R9648**.....ALL  
 Chrome Coil Bracket Only. -0.15  
 ..... \$5.75 EA ⚠



**R9650**.....ALL  
 Chrome Ford Coil Bracket Only. -0.15  
 ..... \$6.19 EA ⚠

**Coil Relocation Kit For LS**



**CMW-CRK**.....ALL  
 Relocation brackets allow you to remotely mount your coil packs virtually anywhere. Machined from 6061 Aluminum Black Anodized  
 Designed to work with LS-2,3,7 and 9 (Will not work with truck or LS-1 coils)  
 Kit includes four(4) brackets and all mounting hardware: including spacers (required when using Delphi coils). -0.15  
 ..... \$170.00 EA ⚠

**Spark Plug Wires**

Livewires. Space age, heat resistant sleaving to protect from exhaust heat. Numbered on each end for correct cylinder. Durable silicone jacket and insulation. Spiral wound core prevents electronic interference. No assembly required!



**PEDC9066-E**.....ALL  
 Chevy in-line 6 cyl., Black 0.000 -0.15  
 ..... \$94.75 SET ⚠

**Spark Plug Wires Vintage**



**VPW1B**.....ALL  
 180 degree boots, Black. -0.15  
 ..... \$69.75 SET ⚠

**VPW1Y**.....ALL  
 180 degree boots, Yellow. -0 CALL ⚠

**VPW2B**.....ALL  
 90 degree boots, Black. -0.15  
 ..... \$71.79 SET ⚠

**Wire Looms Billet Specialties**

Billet aluminum ignition wire looms. For use with 8mm wires. Mounts to base of valve cover with adjustable tabs. Size 14-3/4" L x 2-1/4" W. Available in Ball Milled, Smooth or Bowtie



**BIS69520**.....ALL  
 Billet Specialties. Ball milled, billet aluminum ignition wire looms. For use with 8mm wires. Mounts to base of valve cover with adjustable tabs. Size 14-3/4" L x 2-1/4" W. 2.251 -0.15  
 .... \$65.25 PR ⚠



**BIS69523**.....ALL  
 Billet Specialties. Bowtie w/ ball mill, billet aluminum ignition wire looms. For use with 8mm wires. Mounts to base of valve cover with adjustable tabs. Size 14-3/4" L x 2-1/4" W. 2.251 -0.15  
 .... \$80.00 PR ⚠



**BIS69529**.....ALL  
 Billet Specialties. Smooth, billet aluminum ignition wire looms. For use with 8mm wires. Mounts to base of valve cover with adjustable tabs. Size 14-3/4" L x 2-1/4" W. 2.251 -0  
 ..... \$60.49 PR ⚠

**Wire Looms Billet Specialties, cont.**



**BIS69600**.....ALL  
 Mounting bracket kit for center bolt valve covers. Bolts to side of head. 2.251 -0  
 ..... \$11.09 SET ⚠

**Wire Looms**

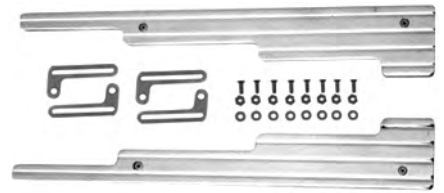

**R6038**.....ALL  
 Polished Aluminum 2 Piece Wire Loom with Bracket - Universal Application for Perimeter Mounted Valve Covers - Ball Milled. -0.15  
 ..... \$61.25 PR ⚠

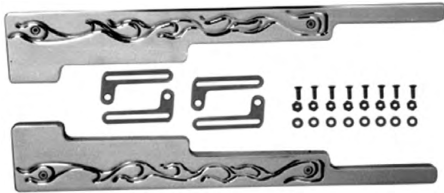

**R6038XC**.....ALL  
 Chrome Aluminum 2 Piece Wire Loom with Bracket - Universal Application for Perimeter Mounted Valve Covers - Flame. -0.15  
 ..... \$78.75 PR ⚠



**R7251**.....ALL  
 Chrome Deluxe Universal Linear Wire Loom Set (Package of 2). -0.15  
 ..... \$18.25 EA ⚠

**Spark Plug Wire Separators Billet Specialties**

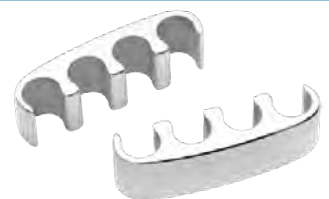

**BIS69601**.....ALL  
 Spark plug wire separator. Floating for 4 ignition wires. Polished and sold in Pairs. 2.251 -0.15  
 ..... \$12.25 PR ⚠

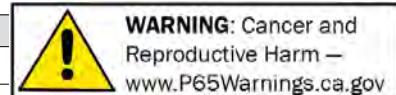

**Spark Plug Wire Separators Billet Specialties, cont.**



**BIS69602**.....ALL  
Spark plug wire separator. Floating for 2 ignition wires. Polished and sold in Pairs. 2.251-0.15 .. **\$12.25 PR** ⚠



**BIS69604**.....ALL  
Spark plug wire separator. Cylinder head mounted for 4 ignition wires. Polished and sold in Pairs. 2.251-0 .. **\$14.89 PR** ⚠



**BIS69681**.....ALL  
Spark plug wire separator. Floating for 4 ignition wires. Black powdercoated and sold in Pairs. 2.251-0 .. **\$12.09 PR** ⚠



**BIS69682**.....ALL  
Spark plug wire separator. Floating for 2 ignition wires. Black powdercoated and sold in Pairs. 2.251-0 .. **\$12.09 PR** ⚠



**BIS69684**.....ALL  
Spark plug wire separator. Cylinder head mounted for 4 ignition wires. Black powdercoated and sold in Pairs. 2.251-0 .. **\$15.79 PR** ⚠

**Spark Plug Wire Separators Billet Specialties, cont.**



**BIS69701**.....ALL  
Spark plug wire separator. Valve cover mounted for 1 ignition wire. Polished and sold in Pairs. 2.251-0 .. **\$14.89 PR** ⚠



**BIS69702**.....ALL  
Spark plug wire separator. Valve cover mounted for 2 ignition wires. Polished and sold in Pairs. 2.251-0.15 .. **\$15.75 PR** ⚠



**BIS69703**.....ALL  
Spark plug wire separator. Valve cover mounted for 3 ignition wires. Polished and sold in Pairs. 2.251-0 .. **\$14.89 PR** ⚠



**BIS69704**.....ALL  
Spark plug wire separator. Valve cover mounted for 4 ignition wires. Polished and sold in Pairs. 2.251-0.15 .. **\$15.75 PR** ⚠



**BIS69781**.....ALL  
Spark plug wire separator. Valve cover mounted for 1 ignition wire. Black powdercoated and sold in Pairs. 2.251-0.15 .. **\$17.00 PR** ⚠

**Spark Plug Wire Separators Billet Specialties, cont.**



**BIS69782**.....ALL  
Spark plug wire separator. Valve cover mounted for 2 ignition wires. Black powdercoated and sold in Pairs. 2.251-0 .. **\$15.79 PR** ⚠



**BIS69783**.....ALL  
Spark plug wire separator. Valve cover mounted for 3 ignition wires. Black powdercoated and sold in Pairs. 2.251-0 .. **\$15.79 PR** ⚠



**BIS69784**.....ALL  
Spark plug wire separator. Valve cover mounted for 4 ignition wires. Black powdercoated and sold in Pairs. 2.251-0 .. **\$15.79 PR** ⚠

**Wire Separators**



**R4452**.....ALL  
Chrome Standard 2-Hole Wire Loom - 3 3/4" High (Package of 2). -0.15 .. **\$3.29 PR** ⚠



**R6085**.....ALL  
Hose/Wire Line Clamps - 3/16" or 4.5mm (Package of 4). -0.15 .. **\$10.50 EA** ⚠

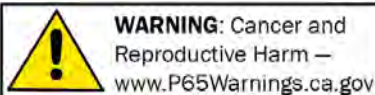

NOTE: Any chemicals will be shipped domestic ground only (Lower 48 states only). No international shipping.



**Wire Separators, cont.**

**R6086**.....ALL  
Hose/Wire Line Clamps - 1/4" or 6.0mm  
(Package of 4). -0.15 ..... **\$10.50 EA** ⚠



**R9097**.....ALL  
Chrome High Lift 4-Hole Wire Loom - 5  
1/4" High (Package of 2). -0.15  
..... **\$5.96 PR** ⚠



**R9372**.....ALL  
Blue Deluxe Wire Divider Set. -0.15  
..... **\$2.73 EA** ⚠



**R9576**.....ALL  
Chrome Pro Style Wire Separators for 8 or  
9 MM Wire. -0.15 ..... **\$5.61 EA** ⚠



**R9577**.....ALL  
Black Pro Style Wire Separators for 8 or 9  
MM Wire. -0.15 ..... **\$5.25 EA** ⚠

**Vacuum End Line Covers**



**R7335**.....ALL  
Chrome Aluminum 2-Piece Vacuum Line  
End Covers for 5/32" I.D. Hose (Package  
of 2). -0.15 ..... **\$10.50 PR** ⚠

**Vacuum Line Caps, cont.**



**R9009**.....ALL  
Vacuum Line Plastic Cap Kit. -0.15  
..... **\$3.25 SET** ⚠

**Push Button Ignition Switch**



**WASL75** .....ALL  
Chrome recessed switch with LED ring.  
Ignition, Start & Stop. Push button and  
hold for start and LED lights up. Push  
again to stop engine. Choose Green, Red  
or Amber. 3/4" dia. -0.15 ..... **\$199.25 EA**  
⚠



**WASL75B** .....ALL  
Black recessed switch with LED ring.  
Ignition, Start & Stop. Push button and  
hold for start and LED lights up. Push  
again to stop engine. Choose Green, Red  
or Amber. 3/4" dia. -0.15 ..... **\$199.00 EA**  
⚠

**RFID Keyless Ignition**



**FR60004** .....ALL  
Hands Free programmable unit that uses  
RFID proximity technology to automatically  
authorize your vehicle to start. The system  
can stand alone in any vehicle, or be  
integrated into any of our tilt columns in a  
paintable, black powdercoat, or polished  
finish.

This new system is fully programmable to  
allow you to use your keyless entry/ trunk  
release system, door poppers, or other  
popular remotely controlled accessories.  
A single fob can even be programmed to  
operate multiple vehicles.

Other convenient features include the  
ability to learn and recognize additional  
key fobs or replacement fobs, an  
emergency bypass mode that allows the  
vehicle to be started using a unique PIN  
#, and a security lockout feature that  
prevents the system from being activated  
when the key fob is inside of the vehicle's  
proximity range.

Kit Includes:  
Ignition Control Module (ICM)  
Two Power Harnesses  
Accessory Harness  
Programming Button  
Emergency Bypass PIN Card  
Start Button (Blue LED is standard - Also  
Available in Red, White and Green)  
Motion Activated RFID Device -0  
..... **\$878.50 EA** ⚠

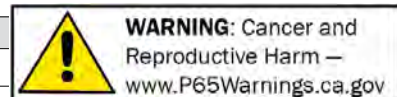

**Basic Auto Electricity Book**



**WASBAEB . . . . ALL**  
 Contains sections on: What is Electricity? Covers the battery, alternator, voltage regulator, grounding and fuses, designing a simple circuit & more including.

Circuit Diagram, Ammeter and Volt Meter usage. A full 48 pages plus Fold out Circuit Diagram and 8-1/2" x 14" Pullout Wiring Diagram to remove and customize to match your own car's circuits.  
 0.000 -0.15

..... **\$11.00 EA** ⚠

**Main Wire Harness Street Rod Route 9**



**510625. . . . . ALL**  
 Route 9 Universal Wiring System from American Autowire. We often receive requests for a basic, or smaller sized, complete wiring system, and this kit is designed just for that market. -0.15  
 ..... **\$289.00 EA** ⚠

**Main Wire Harness Street Rod (Hwy 15)**

HIGHWAY 15 "STREET ROD" WIRING KIT. This is a complete fuse panel and full wiring kit.  
 - Developed to handle the most demanding power requirements and accessories.  
 - Longer coils of wire so you can place the fuse box where YOU want it.



**13237. . . . . ALL**  
 American Autowire Highway 15-Street Rod Wire Harness 8.055 -0.15 **\$419.50 KIT** ⚠

**Main Wire Harness Street Rod (Hwy 15-Nostalgia)**

HIGHWAY 15 "NOSTALGIA" WIRING KIT. Complete fuse panel and full wiring kit. As if directly out of the 50's, this great looking system is put together with the top selling street rod wiring system. The traditional Braid & Lacquer wire, with its high gloss finish and extremely colorful flare will add that needed finishing touch while giving the best, safest and easiest to install electrical component system available today! Same great components and features as the standard Highway 15 harness such as:  
 - Longer coils of wire so you can place the fusebox where YOU want it.



**500944. . . . . ALL**  
 American Autowire Highway 15-Nostalgia (Braided & Lacquered Wiring Kit) -0.15  
 ..... **\$1,099.00 KIT** ⚠

**Main Wire Harness Street Rod (Hwy 22)**

The Highway 22 Panel packs all of the punch of a high-powered OEM system into a smaller, easy-to-install and extremely compact front loading package. The components used in this panel far exceed the power handling capabilities of any other manufacturer's system. Easy clamp-style system makes adding and removing wires easy! No Terminals! No Crimping! No Screws! Each Highway Series wiring kit comes with complete, easy to understand instructions to guide you through every step.

**Main Wire Harness Street Rod (Hwy 22), cont.**



**500695. . . . . ALL**  
 Includes modern fuse box, instruction sheet, dash harness, instrument cluster kit, parking lamp kit, rear body kit, power plus front lighting kit, engine & starter kit, courtesy light connection kit, fuse relay flasher kit, ignition switch, headlight switch, dimmer switch and wire ties.  
 2.555 -0.15 ..... **\$489.00 KIT** ⚠



**500917. . . . . ALL**  
 Ford vehicle connection kit. Includes a Generation III alternator plug and adapter, a complete Duraspark Ignition connection kit, and Ford-styled ignition switch and keys. -0.15 ..... **\$175.00 KIT** ⚠

**Retro Wire Harness from Ron Francis**

The "GIT IT RUNNIN'" harness is designed with 30+ years in the do-it-yourself-wiring business. It is for a 6 volt installation that is nearly completely pre-wired. A drop in harness for that cost conscious enthusiast who does not intend to upgrade any components and is staying with a 6 volt system. Uses Hi-Temp cross-link wire, and has a serial number for fast troubleshooting help. It will wire your headlights, tail lights, brake lights, gauges/senders, engine (starter, generator, distributor), ignition switch, headlight switch and Hi/Lo Dimmer Switch. Add turnsignals and a 3rd Brake Light too, the wires are included! There is also wiring for the License Plate Light. Positive OR Negative Ground systems okay!

**WR-54. . . . . ALL**  
 For GM engines. 6 Volt -0.15  
 ..... **\$309.75 SET** ⚠  
**WR-85. . . . . ALL**  
 For GM engines. 12 Volt -0.15  
 ..... **\$309.75 SET** ⚠

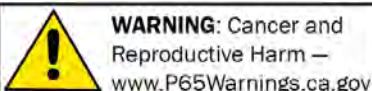

NOTE: Any chemicals will be shipped domestic ground only (Lower 48 states only). No international shipping.

**Wiring Harness Ron Francis Chevy And Ford Trucks**

**XP-752 .....ALL**

- Chevy or Ford V8 Engines
- \*One-Wire, GM and Ford Alternators
- \*Stock, GM or Aftermarket Columns
- \*Accepts Electronic Fuel Injection
- \*Includes Firewall Connector Cover
- \*Electronic, Dura Spark or Points Distributors
- \*Generator Wiring Available on Request
- \*New Headlight Switch Included
- \*Specify Year and Make
- \*Freedom of Panel Installation

Locations -0.15 ..... **\$499.75 SET** ⚠

**Powered Express Wire Harness from Ron Francis**



**XP-66 .....ALL**

Wiring System - GM Powered Express Series.  
We built these kits to fit your custom application. Wiring is included for the complete car, including starter, alternator, most stock GM, Ididit, Flaming River and other brands of steering columns. It will wire full gauge sets including tach, HEI, points and aftermarket distributors, neutral safety switches, all lighting needed for most safety inspections including high and low beams, indicator lights, parking, turn signal, brake and third brake light. The panel readily accepts fuel injection. The EXPRESS has been simplified over previous models to speed installation. We use HIGH TEMPERATURE fire resistant, color-coded wire with the circuit clearly and legibly printed. A quality headlight switch with wiring is included, as well as an isolated cooling fan relay. Our COLOR CODED INSTRUCTIONS are famous. A unique serial number for each kit enables us to technically support the installation to you or any subsequent owner. -0.15  
..... **\$499.75 SET** ⚠

**Powered Express Wire Harness from Ron Francis, cont.**



**XP-67 .....ALL**

Wiring is included for the complete car... starter, one-wire alternator (external alternators add VR-99), points, Dura-Spark and aftermarket distributors. It will also wire the full gauge set including tach and neutral safety switches; and for all lighting needed for most safety inspections including Hi and Lo beams, indicator lights, parking, turn signal, brake and third brake light.

-0.15 ..... **\$499.75 SET** ⚠

**XP726.....ALL**

- \*Ford Powered Classics
- \*One-Wire and Ford Alternators
- \*Ford, GM and Aftermarket Columns
- \*Dura Spark and Points Distributor
- \*Column or Dash Ignition
- \*New Headlight Switch Included
- \*Accepts Electronic Fuel Injection

-0.15 ..... **\$499.75 SET** ⚠

**6v to 12v Conversion Harness from Ron Francis**



**CK-540 .....ALL**

Converts your stock 6 volt engine to 12 volt or upgrade your existing 12 volt. -0.15

..... **\$421.00 SET** ⚠

**Main Wire Harness Street Rod Truck**

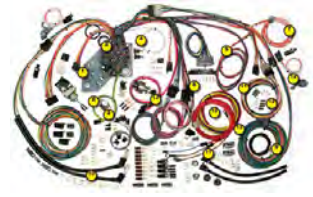

**2960053SR .....47-55**

For 1947-55 Chevy Trucks. Built on the new 18 fuse, 21 circuit fuse box system, kit comes completely ready to install under the dash. Includes modern fuse box, instruction sheet, dash harness, instrument cluster kit, parking lamp kit, rear body kit, power plus front lighting kit, engine & starter kit, courtesy light connection kit, fuse relay flasher kit, ignition switch, headlight switch, dimmer switch and wire ties. 2.555 -0.15

..... **\$599.00 SET** ⚠

**Voltage Reducer**



**1119004 .....ALL**

Reducer 12v to 6v. Best for fuel gauge. Hi-Tech w/ constant volts. 2.500 -0.15

..... **\$19.00 EA** ⚠



**1119004A .....ALL**

12v conversion. 1 per gauge Hi-Tech w/ voltage not constant. 2.500 -0.15

..... **\$4.50 EA** ⚠



**1119005 .....ALL**

12v to 6v voltage reducer to operate heater, radio & gauges. Hi-tech, delivers constant volts. Superior quality. 2.500 -0.15

..... **\$93.25 EA** ⚠

**Voltage Reducer, cont.**



**1119005C** .....ALL  
12v to 6v voltage reducer to operate  
heater. 2.500 -0.15 ..... **\$19.75 EA** ⚠



**1506373A** .....ALL  
12v to 6v. Up to 4 amp draw affects  
voltage. 2.500 -0.4 ..... **\$8.50 EA** ⚠

**Voltage Booster**



**1119007** .....ALL  
6v to 12v high current booster (3.7-5.0  
amps) great for: radar detectors, CB  
radios, mobile phones, modern stereo  
radios w/ CD & tape and alarm systems  
(control only). 2.500 -0.15 ..... **\$105.25 EA**  
⚠

**Horns**



**9000518** .....40-54  
W/ relay, 12v (pair). 2.810 -0.15  
..... **\$69.00 SET** ⚠

**Horns, cont.**



**46128** .....ALL  
Wolf Whistle  
Designed as Original  
Works Reliably  
Die Cast Metal with all Metal Hardware  
Classic Wolf Sound  
Has Strong Vacuum Hose and Instructions  
-0.15 ..... **\$59.00 EA** ⚠



**HORN3** .....ALL  
Oogah horn. Heavy duty 12 volt motor.  
Easy installation. Limited lifetime warranty.  
2.810 -0.2 ..... **\$41.75 EA** ⚠



**R1011** .....ALL  
Hi/lo twin horns. Chrome. W/relay &  
mounting hw. -0.15 ..... **\$35.00 PR** ⚠

**Wire Port**

Ball milled, billet aluminum housings finish off  
your firewall and hide electrical pass-thru. 2  
styles.



**WASB16** .....ALL  
Ball milled, round billet aluminum housing  
to finish off your firewall and hide electrical  
pass-thru. 2" O.D., 1-1/2" I.D. 4 truss  
head screws. -0.15 ..... **\$49.00 EA** ⚠

**Wire Port, cont.**



**WASB21** .....ALL  
Ball milled, dome type billet aluminum  
housing to finish off your firewall and hide  
electrical pass-thru. 1-1/2" x 2" tall x 1"  
deep. Blind fastens from inside  
firewall. -0.15 ..... **\$59.00 EA** ⚠

**MAG DADDY Universal Magnetic Clips**



**MDU-CABLEB** .....ALL  
Mag Daddy Universal magnetic cable clip  
black - 5 pack. Great for holding cables  
anywhere you can stick a magnet.  
8.950 -0.15 ..... **\$12.50 SET** ⚠



**MDU-CABLEMD** .....ALL  
Mag Daddy Universal magnetic cable clip  
black - 3 pack. Great for holding cables  
anywhere you can stick a magnet.  
8.950 -0.15 ..... **\$7.50 SET** ⚠



**MDU-CABLEW** .....ALL  
Mag Daddy Universal magnetic cable clip  
white - 5 pack. Great for holding cables  
anywhere you can stick a magnet.  
8.950 -0.15 ..... **\$9.75 SET** ⚠

**MAG DADDY Universal Magnetic Clips, cont.**



**MDU-STARTERKIT** .....ALL  
Mag Daddy Universal Starter Kit  
8.950 -0.15 ..... **\$77.29 SET** ⚠



**MDU-WIREKITB** .....ALL  
Mag Daddy Universal Wire / Cable Kit.  
Black. Great for holding cables anywhere  
you can stick a magnet. 8.950 -0  
..... **\$74.99 SET** ⚠



**MDU-WIREKITW** .....ALL  
Mag Daddy Universal Wire / Cable Kit.  
White 8.950 -0.15 ..... **\$75.00 SET** ⚠



**MDU-ZIPB** .....ALL  
Mag Daddy Universal magnetic zip clip  
black - 5 pack. Great for holding cables  
anywhere you can stick a magnet. For use  
with zip ties. 8.950 -0.15 ..... **\$12.49 SET**  
⚠



**MDU-ZIPW** .....ALL  
Mag Daddy Universal magnetic zip clip  
white - 5 pack. Great for holding cables  
anywhere you can stick a magnet. For use  
with zip ties. 8.950 -0.15 ..... **\$12.49 SET**  
⚠

**Aluminum Bundle Straps**



**13196** .....ALL  
.25" W X 4.05" L  
Used to bundle wires or hoses. -0.2  
..... **\$4.00 EA** ⚠



**13197** .....ALL  
.25" W X 7.15" L  
Used to bundle wires or hoses -0.2  
..... **\$5.00 EA** ⚠

**Wire Clamp**



**120521** .....ALL  
1/4 in. bolt-on strap. For wire or tube (4  
pcs). 8.950 -0.4 ..... **\$2.59 SET** ⚠



**120521A** .....ALL  
5/16 in. insulated bolt-on strap. For wire  
or tube (4 pcs). 8.950 -0.4 .. **\$3.29 SET**  
⚠



**120521B** .....ALL  
3/8 in. bolt-on strap. For wire or tube (4  
pcs). 8.950 -0.4 ..... **\$2.79 SET** ⚠

**Wiring Socket Universal**



**TR-33** .....ALL  
Weather protection boot, 15 inches long.  
Ideal for 1955 and newer Chevy's as well  
as step side pickups! Hole Size .75.  
Typically uses 1157 & 1077 bulbs. -0.15  
..... **\$62.75 PR** ⚠

**Flush Mount Lens Panel Housings**

Lens boxes are designed to hold lenses in place and can be trimmed to match flat or curved panel contours to flush mount a lens set you choose. Powdercoated white & constructed from 20 gauge steel. Available in Low profile (2.5 inches of back clearance) or Standard (5 inches of back clearance). Units come complete including LED bulbs to give you turn signal and running lights. Match lens size with housing size. Amber lens kits can be mounted front or rear.

**Lens Panel Housing 4 inch**

**HAG4LLEDH** ..... **ALL** LED. Low profile housing for use with 4 inch light panels. Single Row 2.682 -0.15 ..... **\$155.49 SET** ⚠

**HAG4LLEDH2** ..... **ALL** LED. Standard profile housing for use with 4 inch light panels. Double row LED 2.682 -0.15 ..... **\$185.25 SET** ⚠

**Lens Panel Housing 6 inch**

**HAG6LLEDH2** ..... **ALL** LED. Standard profile housing for use with 6 inch light panels. Double row LED 2.682 -0.15 ..... **\$210.25 SET** ⚠

**Flush Mount Amber Lens Panels**

Hagan flush mounted lens kits are a great way to smooth out the lines of your ride bringing you a variety of choices in style and size without having to create from anything scratch. Mounted on mild steel, the 1/4 inch thick lens gets sanded down flush with the panel. Complete instructions included. Find matching tail lights in Section 110.

**Flush Mount Amber Lens Panel Kit 2-3/4 inch**

Use 4" lens panel housings for 2-3/4" flush mount lens panels.

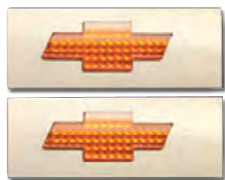

**HAGBT1A** ..... **ALL** Amber, Chevrolet Bowtie. Bowtie measures 3in. x 1-1/4in. Order light box set HAG4LLEDH or HAG4LLEDH2 2.682 -0.15 ..... **\$53.75 SET** ⚠

**Flush Mount Amber Lens Panel Kit 4 inch**

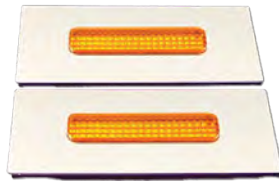

**HAG4RCA** ..... **ALL** Amber, Wide Single, rectangular slot lens (rounded ends). Lens is 7/8INCH x 4INCH. 2.682 -0.15 ..... **\$50.00 SET** ⚠

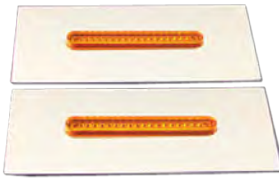

**HAG4SSA** ..... **ALL** Amber, Single, rectangular slot lens (rounded ends). Lens measures 1/2INCH x 4INCH. 2.682 -0.15 ..... **\$50.00 SET** ⚠

**Flush Mount Amber Lens Panel Kit 6 inch**

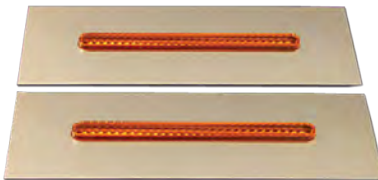

**HAG6SSA** ..... **ALL** Amber, Single, rectangular slot lens (rounded ends). Lens measures 1/2in. x 6in. 2.682 -0.15 ..... **\$64.50 SET** ⚠

**Billet Park Light Rims Chevy Truck**

Polished billet aluminum in 2 design styles. Mounts to original bucket & lens.



**312810** ..... **47-53** Polished billet aluminum (open design). Mounts to original bucket & lens. 2.593 -0 ..... **CALL** ⚠

**Turn Signal Assembly 39 LED Chevy Style**



**916877CLA** ..... **39-52** Chrome housing w/ Amber LED & lens. 12V 2.679 -0.15 ..... **\$80.00 EA** ⚠



**916877CLAC** ..... **39-52** Chrome housing w/ Amber LED & Clear lens. 12V 2.679 -0.15 ..... **\$80.00 EA** ⚠



**916877LA** ..... **39-52** Primered housing, Amber LED & lens. 12V 2.679 -0.15 ..... **\$80.00 EA** ⚠



**916877LAC** ..... **47-53** LED. Primered housing w/ Amber LED & CLEAR lens. 12V 2.679 -0.15 ..... **\$80.00 EA** ⚠

**Signal Light**



**RODLIGHTBULLETA** ..... **37-64** Small, amber LED marker light w/ chrome housing. Dual function. 2.585 -0.15 ..... **\$51.00 EA** ⚠

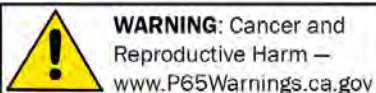

NOTE: Any chemicals will be shipped domestic ground only (Lower 48 states only). No international shipping.

**Signal Light, cont.**



**RODLIGHTBULLETR**.....**.37-64**  
 Small, red LED marker light w/ chrome housing. Dual function. 2.585 -0.15  
 ..... **\$50.00 EA** ⚠



**RODLIGHTAL**.....**.ALL**  
 Large, amber marker/ turn signal light w/ chrome housing. Double element.  
 2.585 -0.15 ..... **\$15.00 EA** ⚠



**RODLIGHTAM**.....**.ALL**  
 Medium, amber marker/ turn signal light w/ chrome housing. Double element.  
 2.585 -0.15 ..... **\$13.00 EA** ⚠



**RODLIGHTAS**.....**.ALL**  
 Small, amber marker light w/ chrome housing. Single element. 2.585 -0.15  
 ..... **\$10.19 EA** ⚠



**RODLIGHTBULB**.....**.ALL**  
 Dual filament with offset pins. 12 volt -0.15  
 ..... **\$2.50 EA** ⚠

**Signal Light, cont.**



**WASL-JE01**.....**.ALL**  
 Make small marker light "RODLIGHTAS" a dual function light with this conversion!  
 Includes instructions. -0.15 ..... **\$5.00 EA** ⚠

**Bulbs LED 6 & 12 Volt**

Note: LEDs are very directional and need to be angled correctly to be bright. Minimal current draw.



**145416J**.....**.ALL**  
 12V Amber, offset pins. Replaces bulb #1157. Use LED flasher #3713382L.  
 8.991 -0.3 ..... **\$9.50 EA** ⚠



**145416K**.....**.ALL**  
 12v Amber, straight pins. Replaces bulb #1156. Use LED flasher #3713382L.  
 8.991 -0.15 ..... **\$12.25 EA** ⚠



**145416LED6A**.....**.ALL**  
 6V Amber, straight pins. single contact  
 Replaces bulb #1156. 8.991 -0.15  
 ..... **\$15.00 EA** ⚠

**145416N**.....**.ALL**  
 12v Amber, straight pins. Replaces bulb #1156. Use LED flasher #3713382L.  
 8.991 -0.15 ..... **\$14.99 EA** ⚠

**Dual Intensity Light Converter**

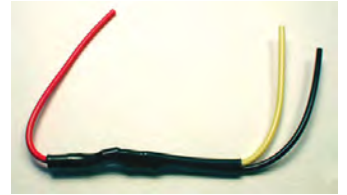

**WASL-JE02**.....**.ALL**  
 Converts LED lights from single function to dual for tail & brake lights. One per light needed. 20-60 LED's -0.15 .. **\$5.00 EA** ⚠



**WASL-JE03**.....**.ALL**  
 Converts LED lights from single function to dual for tail & brake lights. One per light needed. 5-20 LED's -0.15 ..... **\$5.00 EA** ⚠

**Turn Signal Kit Self Canceling**

- \* Operates on all cars - 6 or 12 volts, Positive or Negative Ground.
- \* Self Cancel feature uses time and lack of brake signal to know when to cancel.
- \* Time-out user adjustable for 15, 30, 45 or 60 seconds. Factory set for 15 seconds. Turn signal will not time out with the brakes applied.
- \* Audible beep on turn - user selectable for On/Off.
- \* Easy installation with included instructions, wiring diagrams and terminal labels on control.
- \* Fail safes with brake and park lights still functional even with blown turn signal control fuse or no power to the control box.
- \* Can operate with combined brake and turn lights or separate brake and turn lamps in rear of car.
- \* Can share front Park or Fog lights for front turn signals.
- \* Flash rate independent of lamp load. Will flash LED lamps or incandescent lamps at the same rate.
- \* 4-way Hazard function.
- \* Controller can use any style momentary switch(es) to access all control functions.
- \* 10 pin European style screw terminal connector prewired for power, ground and signal switch plug.
- \* Internal 15 amp turn function fuse and separate Park and Brake circuit 10 amp fuses.
- \* Quick disconnect of control box for easy service. Simply unplug the 10 pin connector.



**9857209B** .....ALL  
 Black column switch. 6 or 12 volt, positive or negative ground. Self canceling. -0.15  
 ..... **\$250.00 EA** ⚠



**9857209P** .....ALL  
 Plain column switch. 6 or 12 volt, positive or negative ground. Self canceling. -0.15  
 ..... **\$250.00 EA** ⚠

**Turn Signal Kit Self Canceling, cont.**



**9857209T** .....ALL  
 Toggle switch. 6 or 12 volt, positive or negative ground. Self canceling. -0.15  
 ..... **\$140.00 EA** ⚠

**Manual Cancelling Turn Signal Switch Kit**



**WASL10-T** .....ALL  
 7/8" long metal toggle switch for left or right turn indication, center off. Switch controls 40 amp brake light override circuitry to let you use a single brake/turn bulb (such as 1157). Dash or console mount. Complete with wire leads, instructions and schematic. Uses a single two-prong flasher (not included). -0.15  
 ..... **\$79.00 SET** ⚠

**Turn Signal Kit With Harness Chevy Cars**



**9857206K** .....37-52  
 W/ (2) 6v halogen bulbs, wire harness, flasher sockets & switch (specify year when ordering). 2.761-0  
 ..... **starting at \$325.00 SET** ⚠

**9857212K** .....37-52  
 W/ (2) 12v halogen bulbs, wire harness, flasher sockets & switch (specify year when ordering). 2.761-0  
 ..... **starting at \$315.00 SET** ⚠

**Turn Signal Kit Without Harness Chevy Cars**

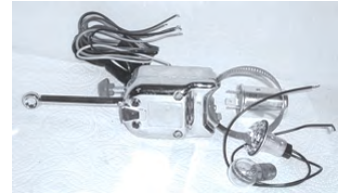

**9857207K** .....37-52  
 W/ (2) 6v halogen bulbs, flasher sockets & switch, w/out wire harness (specify year when ordering). 2.761-0  
 ..... **starting at \$115.00 SET** ⚠

**Turn Signal Kit With Harness Chevy Trucks**



**9857206TK** .....37-53  
 W/ (2) 6v halogen bulbs, wire harness, flasher sockets & switch (specify year when ordering). 2.761-0  
 ..... **starting at \$240.00 SET** ⚠

**9857212TK** .....37-53  
 W/ (2) 12v halogen bulbs, wire harness, flasher sockets & switch (specify year when ordering). 2.761-0  
 ..... **starting at \$240.00 SET** ⚠

**Turn Signal Kit Without Harness Chevy Trucks**



**9857207TK** .....37-53  
 Comes With (2) 6v halogen bulbs, flasher sockets & switch, w/out wire harness (specify year when ordering). 2.761-0  
 ..... **starting at \$110.00 SET** ⚠

**9857208TK** .....37-53  
 Comes With (2) 12v halogen bulbs, flasher sockets & switch, w/out wire harness (specify year when ordering). 2.761-0  
 ..... **starting at \$120.00 SET** ⚠

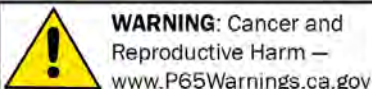

NOTE: Any chemicals will be shipped domestic ground only (Lower 48 states only). No international shipping.



**Turn Signal Flasher**



**1335230** .....ALL  
6v 3 prong 2.892 -0.4 ..... **\$8.00 EA** ⚠



**3713382** .....ALL  
12v 3 prong 2.892 -0.2 ..... **\$9.75 EA** ⚠

**Turn Signal Flasher Audible**



**1335230TA** .....ALL  
Audible flasher. 6v, 3 prong. 2.892 -0.15  
..... **\$36.25 EA** ⚠

**3713382TA** .....ALL  
Audible flasher. 12v, 3 prong. 2.892 -0.15  
..... **\$32.50 EA** ⚠

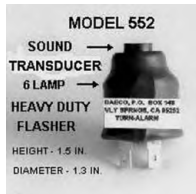

**FF552TA** .....ALL  
Audible flasher. 12v, 2 prong. -0.15  
..... **\$29.25 EA** ⚠

**Turn Signal Flasher LED**



**3713382L** .....ALL  
12v. For use w/ LED lights (3 prong). Low  
load . 2.892 -0.15 ..... **\$12.50 EA** ⚠

**3713382L2** .....ALL  
12v. For use w/ LED lights (2 prong). Low  
load. 2.892 -0.15 ..... **\$14.75 EA** ⚠



**FF552NL** .....ALL  
12v. For use w/ LED lights (2 prong).  
Adjustable blinker speed. 2.892 -0.15  
..... **\$40.00 EA** ⚠



**FF552NLF** .....ALL  
12v. For use w/ LED (2 prong). Fixed  
blinker speed. 2.892 -0.15 .. **\$10.25 EA**  
⚠



**FF552NLP** .....ALL  
12v. For use w/ LED (2 prong). Fully  
adjustable PULSING blinker speed control.  
2.892 -0.15 ..... **\$50.00 EA** ⚠



**WASL52DL2** .....ALL  
LED Dummy load box 12v. For use w/ LED  
lights. Creates amperage draw for flasher  
to work properly. 2.892 -0.15 . **\$9.00 PR**  
⚠

**Headlight Assemblies**



**50221** .....ALL  
7 Inch, 12 Volt Headlight Assembly Flat  
Lens H-4 Black Dietz Style -0.15  
..... **\$91.00 PR** ⚠



**50222** .....ALL  
7 Inch, 12 Volt Headlight Assembly Sealed  
Beam Chrome Dietz Style -0.15  
..... **\$90.25 PR** ⚠



**50231** .....ALL  
7 Inch, 12 Volt Headlight Assembly Flat  
Lens H-4 Chrome Kingbee Style -0  
..... **\$90.29 PR** ⚠



**50232** .....ALL  
7 Inch, 12 Volt Headlight Assembly  
Chrystal Lens H-4 Chrome Kingbee  
Style -0.15 ..... **\$129.00 PR** ⚠

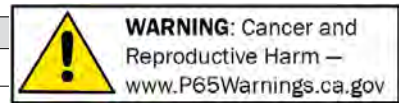

# Section 100: H.I.D. Headlights, Halogen Headlights & Conversions, Frenched Kits, Bulbs, Headlight Components & Switches

## Headlight Frenched Kits

These frenched kits are designed to retro-fit your existing bullet shaped buckets. Bonded or weld-in mounting tabs. Complete installation instructions included. See our large selection of headlight choices on the following pages.

Kits HAG775C & HAG775BS fit the > following cars: 37-38 Buick, 37-38 Chevy, 37 Olds, 37 Willys.

Kits HAG825C & HAG825BS fit the following cars: 36 & 39 Buick, 39-40 Chevy, 36 Chrysler, 35-36 & 39 Dodge, 34, 37-39 Pontiac, 34-36, 38-39 Olds, 35-36, 38 Plymouth, 35-36 Studebaker & 37 Nash/Lafayette.

Kits HAG4050C & HAG4050BS fit the following cars: Buick 1940-1957, Cadillac 1941-1953, Chevy 1941-1957, Chrysler 1939-1956, Croseley 1939-1952, Desoto 1941-1955, Dodge 1939-1956, Ford 1939 Deluxe & 1940-1957, Lincoln 1942-1956, Metro 1954-1962, Mercury 1942-1956, Nash 1940-1954, Olds 1940-1956, Packard 1941-1953, Plymouth 1940-1954, Pontiac 1941-1957, Studebaker 1939-1956



- HAG775BS** .....37-38  
Headlight, Frenched Set -7-3/4" Bare Steel For 5-3/4" Lights, 37-38 Cars  
2.726 -0.15 ..... **\$225.25 SET** ⚠
- HAG775C** .....37-38  
Headlight, Frenched Set -7-3/4" Chrome For 5-3/4" Lights, 37-38 Cars 2.726 -0.15  
..... **\$295.25 SET** ⚠
- HAG825BS** ..... 39  
8-1/4" inch. Bare steel trim rings for 7" lights. 2.726 -0.15 ..... **\$225.19 SET** ⚠
- HAG825C** ..... 39  
8-1/4" inch. Chrome trim rings for 7" lights. 2.726 -0.15 ..... **\$295.29 SET** ⚠

## Headlight Frenched Kits, cont.



- HAG4050BS** .....40-57  
Bare steel kit. 2.726 -0.15 ..... **\$255.25 SET** ⚠



- HAG4050C** .....40-57  
Chrome and cool. 2.726 -0.15 ..... **\$335.50 SET** ⚠

## 7" Headlight Conversion Kit Chevy Car



**920544S** ... 37-38  
This kit consist of a foam/rubber seal that allows you to use 7" lights. Does not include the bucket, headlight or trim. NOTE:

Will not work with #31378 or #31379 or #S2010LED Headlights. Cars only 2.727 -0.3

..... **\$18.75 PR** ⚠

## Sealed Beam Conversion Kit Chevy Cars



**923344S** ..... 39  
Convert your stock housing to 7 inch sealed beam. Includes inner & outer bucket, sealed beam, pigtail & retaining ring. Modification

to original housing required. Includes mounting instructions. Cars only 2.727 -0

..... **\$148.00 EA** ⚠

## 7" LED Headlight Kit



- 5947212L** ..... **ALL**  
Includes 2 - 7 inch headlights and LED bulbs. -0 ..... **\$150.00 SET** ⚠

## Headlight Halogen With LED Halo



- 31380HALO** ..... **ALL**  
7 Inch, 12 Volt Headlight H-4 Halogens With Multi Color LED Halo, Includes Remote (No Turn Signal).  
NOTE: Will not work on 37-38 Sealed Beam Conversion Kit (#920544S) -0.15  
..... **\$250.25 PR** ⚠



- 31381HALO** ..... **ALL**  
7 Inch, 12 Volt Headlight H-4 Halogens With White LED Halo (No Turn Signal)  
NOTE: Will not work on 37-38 Sealed Beam Conversion Kit (#920544S) -0.15  
..... **\$195.25 PR** ⚠

- 31382HALO** ..... **ALL**  
7 Inch, 12 Volt Headlight H-4 Halogens With Multi-Color LED Halo, includes remote. Black Illusion (No Turn Signal)  
NOTE: Will not work on 37-38 Sealed Beam Conversion Kit (#920544S) -0.15  
..... **\$299.99 PR** ⚠



- 31383HALO** ..... **ALL**  
7 Inch, 12 Volt Headlight H-4 Halogens With Multi Color LED Halo and Amber Turn signals, Includes Remote.  
NOTE: Will not work on 37-38 Sealed Beam Conversion Kit (#920544S) -0.15  
..... **\$300.25 PR** ⚠

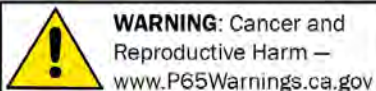

NOTE: Any chemicals will be shipped domestic ground only (Lower 48 states only). No international shipping.

**Section 100: H.I.D. Headlights, Halogen Headlights & Conversions, Frenched Kits, Bulbs, Headlight Components & Switches**

**Headlight Halogen With LED Halo, cont.**



**31384HALO** .....ALL  
 7 Inch, 12 Volt Headlight H-4 Halogens With White LED Halo and Amber Turn Signals.  
 NOTE: Will not work on 37-38 Sealed Beam Conversion Kit (#920544S) -0.15  
 ..... **\$245.25 PR** ⚠

**Headlight Halogen With LED Turn Signal**



**31378** .....ALL  
 7 inch, 12 Volt H-4 Halogens with AMBER LED turn signal or marker lights One row of LED lights on each side. Glass lens.  
 NOTE: Will not work on 37-38 Sealed Beam Conversion Kit (#920544S)  
 2.726 -0.15 ..... **\$62.25 EA** ⚠



**31379** .....ALL  
 7 inch, 12 Volt H-4 Halogens with WHITE LED turn signal or marker lights. One row of LED lights on each side. Glass lens.  
 NOTE: Will not work on 37-38 Sealed Beam Conversion Kit (#920544S)  
 2.726 -0.15 ..... **\$64.00 EA** ⚠



**AUT6001C** .....ALL  
 7 inch, 12 Volt H-4 Halogen with AMBER LED turn signal-marker lights. Two row's of LED lights at the bottom of light. Plastic lens. Driver quality, may have some defects. 2.727 -0 ..... **CALL** ⚠

**Headlight Halogen With LED Turn Signal, cont.**



**S2010LED** .....ALL  
 7 inch, 12 Volt H-4 Halogens with amber LED turn signal-marker lights. One row of LEDs at the bottom of light. Glass lens.  
 NOTE: Will not work on 37-38 Sealed Beam Conversion Kit (#920544S) -0.15  
 ..... **\$44.00 EA** ⚠

**Headlight Halogen**

Clear glass lens with diamond cut reflectors. Comes with H4 55/60 watt xenon filled bulb.



**T50300A** .....-54  
 5-3/4 inch Clear glass w/ diamond cut reflector & Tri-Bar w/ blue-dot. Comes w/ H4 55/60 watt xenon filled bulb. 2.727 -0.15  
 ..... **\$85.09 EA** ⚠



**110185H** .....ALL  
 7 inch 6V. Flat lens & replaceable halogen bulb. 2.727 -0.15 ..... **\$41.50 EA** ⚠



**110185J** .....ALL  
 7 inch crystal replacement glass headlight assy. Curved glass lens with halogen H4/ HB2, 60/55 watt bulb. 12V, replaces H6017 or H6024. 2.727 -0.15  
 ..... **\$40.50 EA** ⚠

**Headlight Halogen, cont.**



**5947212H** .....ALL  
 12V. Flat glass lens & replaceable bulb. 2.727 -0.15 ..... **\$19.50 EA** ⚠



**HAGLSE** .....ALL  
 Snake Eye, halogen sealed 7 inch lamp. Comes with H-4 bulbs. 2.726 -0.15  
 ..... **\$175.00 PR** ⚠



**T50100A** .....ALL  
 5-3/4 inch Clear glass w/ diamond cut reflector. Comes w/ H4 55/60 watt xenon filled bulb. 2.727 -0.15 ..... **\$72.39 EA** ⚠



**T70100A** .....ALL  
 7 inch Clear glass w/ diamond cut reflector. Comes w/ H4 55/60 watt xenon filled bulb. 2.727 -0.15 ..... **\$70.09 EA** ⚠



**T70300A** .....ALL  
 7 inch Clear glass w/ diamond cut reflector & Tri-Bar w/ blue-dot. Comes w/ H4 55/60 watt xenon filled bulb. 2.727 -0.15  
 ..... **\$100.09 EA** ⚠

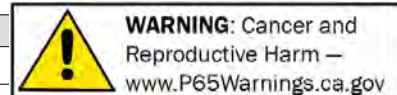

# Section 100: H.I.D. Headlights, Halogen Headlights & Conversions, Frenched Kits, Bulbs, Headlight Components & Switches

## LED Headlight Conversion Kit

The Features Of LED Conversion Kit

1. Brightness reaches 8000 Lumens, in comparison a standard 55w H4 halogen bulb is about 1000 lumens.
2. Anti-glare design, better light pattern output
3. Life span over 30,000 hours
4. Excellent heat dissipation
5. Easy for installation (Plug-in Play)
6. Waterproof and dustproof. IP65



**MAI005**.....ALL  
Single beam LED headlight conversion kit. Replaces 9006 Bulbs  
Input voltage:DC 10V-32V. -0.2  
..... **\$125.89 PR** ⚠



**MAI011**.....ALL  
Hi/Low beam LED headlight conversion kit. Replaces H4 bulbs.  
Voltage: DC 10V-32V. -0.15 . **\$65.00 PR**  
⚠

## HID Plug And Play Headlight Conversions

The Features Of HID Conversion

- Brighter/whiter illumination
- HID lighting provides a crystal white beam of light that increases night time visibility by 3 times.
- Quick snap water proof connectors, 35% less power consumption's that a standard halogen. Over 2000 hours of HID bulb life.

HID (High Intensity Discharge) Headlight Conversion. H4 6000K.

Convert your current halogens to Xenon HID.

Plug and play installation including instructions and ballast mounting hardware.

35 watts will draw less 3 amps.  
3600 Lumens, in comparison a standard 55w H4 halogen bulb is about 1000 lumens.

\*Race use only.



**HIDCONV01** .....ALL  
Low beam Xenon HID w/ H4 Halogen high beam. 6000K.(race use only). 2.727 -0.15  
..... **\$100.00 PR** ⚠

**HIDCONV02** ..... ALL  
Low & High beam Xenon. Converts halogens. H4 6000K. (off-road use only). 2.727 -0.15 ..... **\$165.00 PR** ⚠

## Halogen Headlight Conversion



**110185A** .....31-39  
Halogen bulb. 12V headlight conversion. Double the light of sealed beam, retains original appearance. Uses original lens & reflector. Clear. Some trimming/modifications may be necessary. 8.991 -0.15  
..... **CALL** ⚠

## Halogen Headlight Conversion, cont.

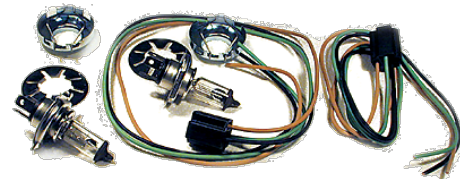

**110185D** .....31-39  
Halogen bulb. 6V headlight conversion. Double the light of sealed beam, retains original appearance. Uses original lens & reflector. Clear. Some trimming/modifications may be necessary. 8.991 -0.15  
..... **\$45.00 PR** ⚠



**920773K** .....37-39  
Reflector w/ clear halogen headlight bulb & dual element amber park light bulbs (12v). Trim to fit. Cars only 2.734 -0.15  
..... **\$131.75 PR** ⚠



**920773KB** .....37-39  
Reflector w/ blue halogen headlight bulb & amber park light bulbs (12v). Trim to fit. 2.734 -0.15 ..... **CALL** ⚠



**920773L**.....37-39  
Reflector w/ clear halogen headlight bulb & clear park light bulbs (6v). Trim to fit. Cars only 2.734 -0.15 ... **\$127.50 PR** ⚠

## Tri-Bar Headlight Cover Chrome Bullet



**193142TC** .....ALL  
Chrome Bullet. Fits 7 inch headlights. 2.731 -0.15 ..... **\$9.75 EA** ⚠

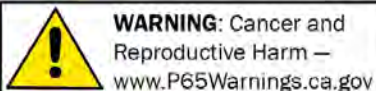

NOTE: Any chemicals will be shipped domestic ground only (Lower 48 states only). No international shipping.

(800) 952-1752 • www.streetrodhq.com

# Section 100: H.I.D. Headlights, Halogen Headlights & Conversions, Frenched Kits, Bulbs, Headlight Components & Switches

## Tri-Bar Headlight Cover Chrome Bullet, cont.

**193142TCQ** ..... ALL  
 Chrome Bullet. Fits 5-3/4 inch headlights.  
 2.731-0.15 ..... \$10.25 EA ⚠

## Tri-Bar Headlight Cover Blue Dot



**193142TB** ..... ALL  
 Blue Dot. Fits 7 inch headlights. 2.731-0.15  
 ..... \$9.00 EA ⚠  
**193142TBQ** ..... ALL  
 Blue Dot. Fits 5-3/4 inch headlights.  
 2.731-0.15 ..... \$12.00 EA ⚠

## Headlight Visors



**193142A** ..... ALL  
 Chrome half moon. Fits 7 inch round  
 headlights. 2.731-0.2 ..... \$9.00 PR ⚠



**193142AM** ..... ALL  
 Amber acrylic with chrome trim plate. Fits  
 7 inch round headlights. 2.731-0.15  
 ..... \$13.25 PR ⚠



**193142B** ..... ALL  
 Chrome plated w/ blue dot jewel. Fits 7  
 inch round headlights. 2.731-0  
 ..... \$14.99 PR ⚠

## Headlight Visors, cont.

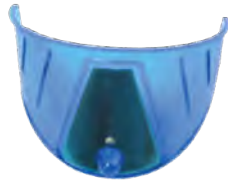

**193142BL** ..... ALL  
 Blue acrylic with chrome trim plate. Fits 7"  
 round. 2.731-0.15 ..... \$13.25 PR ⚠



**193142D** ..... ALL  
 Chrome plated. Fits 7 inch round  
 headlights. 2.731-0.15 .. \$15.00 PR ⚠



**193142GR** ..... ALL  
 Green acrylic with chrome trim plate. Fits  
 7" round. 2.731-0.15 .... \$11.99 PR ⚠



**193142RE** ..... ALL  
 Red acrylic with chrome trim plate. Fits 7"  
 round. 2.731-0.15 ..... \$13.25 PR ⚠

## Halogen Headlight Conversion Bulb



**110185B** ..... ALL  
 Headlight bulb. Clear 6v, H4 replacement.  
 8.991-0.15 ..... \$18.50 EA ⚠  
**110185C** ..... ALL  
 Headlight bulb. Clear 12v, H4  
 replacement. 8.991-0.15 .. \$14.99 EA ⚠

## Bulbs Halogen



**145416B** ..... 37-54  
 Halogen tail light & park light w/ turn  
 signal, 12v, dual filament, 30/10 watt,  
 offset pin, replacement for #1157.  
 8.991-0.15 ..... \$11.90 EA ⚠



**145416C** ..... 37-54  
 Halogen tail light & park light, 6v 50 watt,  
 single filament, straight pin. 8.991-0.3  
 ..... \$7.25 EA ⚠



**145416D** ..... 37-54  
 Halogen tail light & park light, 6v 30 watt,  
 single filament, straight pin. 8.991-0.15  
 ..... \$17.00 EA ⚠



**145416F** ..... 37-54  
 Halogen tail light & park light w/ turn  
 signal, 6v, dual filament, straight pin,  
 replacement for #1158. 8.991-0.15  
 ..... \$27.25 EA ⚠



**145416E** ..... ALL  
 Halogen tail light & park light w/ turn  
 signal, 6v, dual filament, offset pin,  
 replacement for #1154. 8.991-0.15  
 ..... \$17.00 EA ⚠

**Bulbs Halogen, cont.**



**145416G** .....ALL  
Halogen tail light & park light w/ turn signal, 12v, dual filament, 55/5 watt, straight pins, replacement for #1156. 8.991-0.15 ..... **\$20.00 EA** ⚠



**145416H** .....ALL  
Halogen tail light & park light, 12v 20 watt, single filament, straight pin. 8.991-0.3 ..... **\$12.00 EA** ⚠



**145416I** .....ALL  
Halogen tail light & park light, 12v 20 watt, single filament, straight pin. 8.991-0.15 ..... **\$12.25 EA** ⚠

**Dimmer Switch Covers**



**BAG-6006** .....ALL  
Billet aluminum dimmer switch cover w/ rubber insert. 2.459-0.15 ..... **\$25.79 EA** ⚠



**BAG-6006X** .....ALL  
Midnight Series. Billet aluminum dimmer switch cover w/ rubber insert. Black anodized. 2.459-0.15 ..... **\$25.00 EA** ⚠

**Dimmer Switch Covers, cont.**



**SG-6009** .....ALL  
Chrome dimmer switch cover w/ rubber insert. 2.459-0.15 ..... **\$26.50 EA** ⚠



**R8514** .....ALL  
Polished Aluminum with Rubber Insert. -0.15 ..... **\$11.75 EA** ⚠

**Automatic Headlight Switch**



**PAC-1300** .....ALL  
Control your headlights, interior lights and accessory power like current day vehicles. Headlights automatically turn on in low light levels and off with increased light. You can program headlight shutoff time even after vehicle is shut off. Light your path after you leave the vehicle. Programmable control of dome lights for slow fade after door is opened or ignition shut off and use of electric powered accessories after ignition is shut off for programmed duration of up to 20 minutes. Also comes with a unique power regulator to shut off lights & accessories to retain battery power prior to over usage so vehicle may be started. -0.15 ..... **\$200.00 EA** ⚠

**Dual Intensity Light Converter**

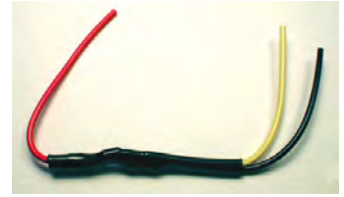

**WASL-JE02** .....ALL  
Converts LED lights from single function to dual for tail & brake lights. One per light needed. 20-60 LED's -0.15 ..... **\$5.00 EA** ⚠



**WASL-JE03** .....ALL  
Converts LED lights from single function to dual for tail & brake lights. One per light needed. 5-20 LED's -0.15 ... **\$5.00 EA** ⚠

**Lens Panel Housings LED**

Lens boxes are designed to hold lenses in place and can be trimmed to match flat or curved panel contours to flush mount a lens set you choose. Powdercoated white & constructed from 20 gauge steel. Available in Low Profile (2.5 inches of back clearance). Units come complete including LED strips to give you turn signal, brake and running lights. Match lens size with housing size.

**Lens Panel Housing 4 inch**

**HAG4LLEDH** ..... ALL  
LED. Low profile housing for use with 4 inch light panels. Single Row 2.682-0.15 ..... **\$155.49 SET** ⚠  
**HAG4LLEDH2** .....ALL  
LED. Standard profile housing for use with 4 inch light panels. Double row LED 2.682-0.15 ..... **\$185.25 SET** ⚠

**Lens Panel Housing 6 inch**

**HAG6LEDH** ..... ALL  
LED housing for use with 6 inch light panels. Single row LED 2.682-0 ..... **\$171.75 SET** ⚠  
**HAG6LLEDH2** ..... ALL  
LED. Standard profile housing for use with 6 inch light panels. Double row LED 2.682-0.15 ..... **\$210.25 SET** ⚠  
**HAG8LLEDH** ..... ALL  
LED. Low profile housing for use with 8 inch light panels. Single row LED 2.682-0.15 ..... **\$171.75 SET** ⚠  
**HAG8LLEDH2** ..... ALL  
LED. Standard housing for use with 8 inch light panels. Double row LED 2.682-0.15 ..... **\$220.25 SET** ⚠

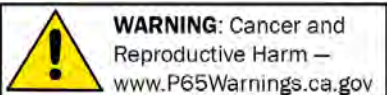

NOTE: Any chemicals will be shipped domestic ground only (Lower 48 states only). No international shipping.

**Lens Panel Housing 10 inch**

**HAG10LLEDH**..... ALL  
LED. Low profile housing for use with 10 inch light panels. Single Row 2.682 -0.15  
..... **\$175.19 SET** ⚠

**HAG10LLEDH2**..... ALL  
LED. Standard housing for use with 10 inch light panels. Double row LED.  
2.682 -0.15 ..... **\$275.25 SET** ⚠

**Lens Panel Housing 12 inch**

**HAG12LLEDH**..... ALL  
LED. Low profile housing for use with 12 inch light panels. Single row LED  
2.682 -0.15 ..... **\$175.25 SET** ⚠

**HAG12LLEDH2**..... ALL  
LED. Standard housing for use with 12 inch light panels. Double row LED  
2.682 -0.15 ..... **\$275.29 SET** ⚠

**Flush Mount Lens Panels**

Hagan flush mounted lens kits are a great way to smooth out the lines of your ride. We offer a variety of styles and sizes saving you from having to build anything from scratch. Mounted on mild steel, the 1/4 inch thick acrylic lens gets sanded down flush with the panel. Complete instructions included. Don't forget to pickup the bonding agent part #HAGRNO which fastens the plastic lens to the metal panel. For Amber lens kits, refer to section 080.

**Flush Mount Lens Panels 2-3/4 inch**

Use 4" lens panel housings for 2-3/4" flush mount lens panels.

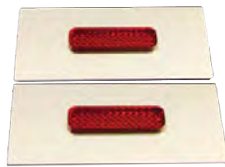

**HAG275RCR**.....ALL  
Red, Wide Single, rectangular slot lens (rounded ends). Lens is 7/8" x 2-3/4".  
2.682 -0.15 ..... **\$50.00 SET** ⚠

**Flush Mount Lens Panels 2-3/4 inch, cont.**

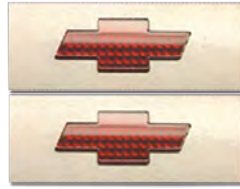

**HAGBT1R**.....ALL  
Red, Chevrolet Bowtie. Bowtie measures 3" x 1-1/4" Order light box set HAG4LLEDH or HAG4LLEDH2 2.682 -0.15  
..... **\$53.59 SET** ⚠



**HAGVDR**.....ALL  
Red, Double V lenses. Total lens height is 3-1/2 inches x 1-5/8" wide. Order light box set HAG4LLEDH or HAG4LLEDH2 2.682 -0.15  
..... **\$50.00 SET** ⚠

**Flush Mount Lens Panels 4 inch**



**HAG4DSR**.....ALL  
Red, Double slot, rectangular lens (rounded ends). Lenses are 1/2" x 4" and 1/2" apart. 2.682 -0.15 .. **\$50.00 SET** ⚠

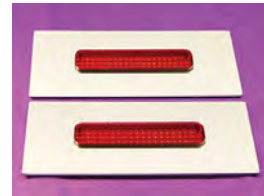

**HAG4RCR**.....ALL  
Red, Wide Single, rectangular slot lens (rounded ends). Lens is 7/8" x 4".  
2.682 -0.15 ..... **\$50.09 SET** ⚠



**HAG4SSR**.....ALL  
Red, Single, rectangular slot lens (rounded ends). Lens measures 1/2" x 4". 2.682 -0.15  
..... **\$50.09 SET** ⚠

**Flush Mount Lens Panels 4 inch, cont.**

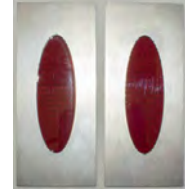

**HAGOVR**.....ALL  
Red, Oval. Mount vertically or horizontally. Lens is 4-1/4" x 1-1/2". 2.682 -0.15  
..... **\$50.00 SET** ⚠

**Flush Mount Lens Panels 6 inch**



**HAG6SS**.....ALL  
Red, Single, rectangular slot lens (rounded ends). Lens measures 1/2" x 6". 2.682 -0.15  
..... **\$60.09 SET** ⚠



**HAG6TDR**.....ALL  
Red, Teardrop lens. Mount vertically or horizontally. Lens is 3/4" x 6". 2.682 -0.15  
..... **\$60.25 SET** ⚠

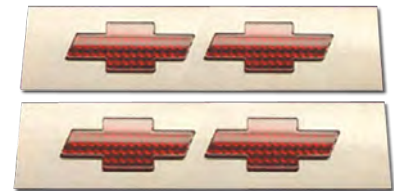

**HAGBT2R**.....ALL  
Red, Chevrolet double Bowtie lens. Each Bowtie measures 3" x 1-1/4" Order light box set HAG6LLEDH. 2.682 -0.15  
..... **\$60.25 SET** ⚠

**Flush Mount Lens Panels 8 inch**

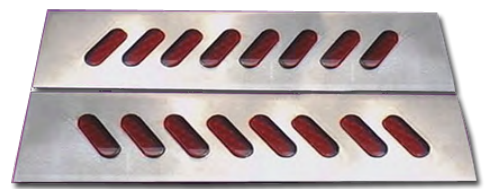

**HAG8AG**.....ALL  
Red, Angled slot lens. Slots are 1/2" x 1.5", 8 slots total each panel. 2.682 -0.15  
..... **\$60.00 SET** ⚠

**Flush Mount Lens Panels 8 inch**



**HAG8DS** .....ALL  
 Red, Double slot, rectangular lens (rounded ends). Lenses are 1/2" x 8" and 1/2" apart. 2.682 -0.15 . **\$60.25 SET** ⚠️

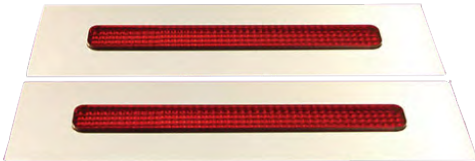

**HAG8RC** .....ALL  
 Red, Wide Single, rectangular slot lens (rounded ends). Lens is 7/8" x 8". 2.682 -0.15 ..... **\$60.09 SET** ⚠️



**HAG8SS** .....ALL  
 Red, Single, rectangular slot lens (rounded ends). Lens measures 1/2" x 8". 2.682 -0.15 ..... **\$64.50 SET** ⚠️

**Flush Mount Lens Panels 10 inch**

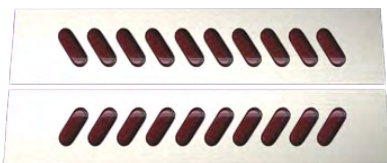

**HAG10AG** .....ALL  
 Red, Angled slot lens. Slots are 1/2" x 1.5", 10 slots total each panel. 2.682 -0.15 ..... **\$70.00 SET** ⚠️



**HAG10DS** .....ALL  
 Red, Double slot, rectangular lens (rounded ends). Lenses are 1/2" x 10" and 1/2" apart. 2.682 -0.15 **\$70.25 SET** ⚠️

**Flush Mount Lens Panels 10 inch, cont.**



**HAG10SS** .....ALL  
 Red, Single, rectangular slot lens (rounded ends). Lens measures 1/2" x 10". 2.682 -0.15 ..... **\$70.09 SET** ⚠️

**Flush Mount Lens Panels 12 inch**

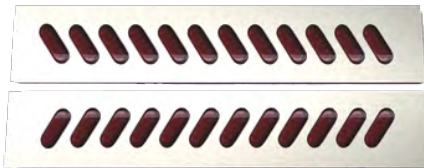

**HAG12AG** .....ALL  
 Red, Angled slot lens. Slots are 1/2" x 1.5", 12 slots total each panel. 2.682 -0.15 ..... **\$70.09 SET** ⚠️



**HAG12DS** .....ALL  
 Red, Double slot, rectangular lens (rounded ends). Lenses are 1/2" x 12" and 1/2" apart. 2.682 -0.15 **\$70.09 SET** ⚠️



**HAG12RC** .....ALL  
 Red, Wide Single, rectangular slot lens (rounded ends). Lens is 7/8" x 12". 2.682 -0.15 ..... **\$75.25 SET** ⚠️

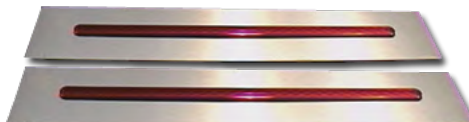

**HAG12SS** .....ALL  
 Red, Single, rectangular slot lens (rounded ends). Lens measures 1/2" x 12". 2.682 -0.15 ..... **\$70.25 SET** ⚠️

**LED Flush Mount Lens Panel Kits 7-1/2 inch**

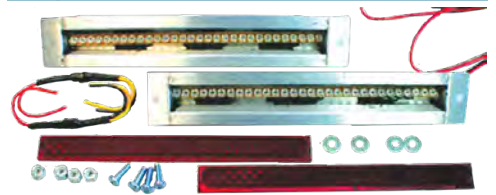

**WASL58SM** .....ALL  
 30 Super Bright Red LED strips per light. Lenses are 7-1/2" x 1-1/2". 12 VOLT ONLY -0.15 ..... **\$169.25 PR** ⚠️

**LED Flush Mount Lens Panel Kits 16 inch**

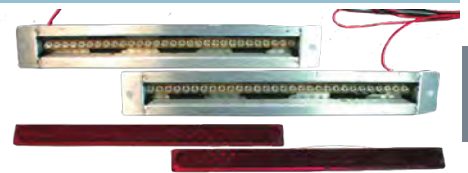

**WASL58** .....ALL  
 60 LED strips fit inside an aluminum housing and mounts behind built-in, flush mounted acrylic lenses with clear prismatic diffusers. 15-1/4" long x 1/2" wide x 1/4" thick lenses can be mounted into gently curved fenders, roll pans and pickup bed corners (designed to curve but not bend). Dual intensity for tail lights, turn & brake lights. Housing needs only 1" of clearance. Weld-in or glass-in studs for mounting and instructions included. -0.15 ..... **\$199.25 PR** ⚠️



**WASL58-SEQ** .....ALL  
 Sequential Signals. Same as WASL58 taillights, but three steps better. Split into groups of 20 LEDs that sequence inside-out for turn signals. Brake lights quickly sequence once then all stay on. All necessary convertors and sequencing modules included along with great instructions. Includes dummy loads for flasher operations. 12 volt only -0.15 ..... **\$349.50 PR** ⚠️

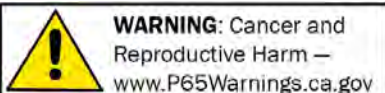

NOTE: Any chemicals will be shipped domestic ground only (Lower 48 states only). No international shipping.



**LED Tail Light Assembly Lokar Oval**

Low profile (extends just 3-16" outside of body). Only requires 1-1/2" of backspace to mount. Complete units come with chromed billet bezel, smooth recessed lens and internal prism. Turn, Tail and Brake lights. Includes stainless hardware and zinc plated mounting brackets & instructions. Available in 2 sizes, Standard and Large.



- TL-1910** .....ALL  
Standard 2-3/4" x 5-1/2". 12 Volt  
2.679 -0.15 ..... **\$432.00 PR** ⚠
- TL-1911** .....ALL  
Large 3" x 6-1/2". 12 Volt 2.679 -0.15  
..... **\$432.00 PR** ⚠

**Tail Light Assembly (Billet Specialties)**

Billet tail lights. Extra bright lens make them as functional as they are cool. 1157 dual element bulb for brake/ turn signal and running light functions.



- BIS61125** .....ALL  
Split bezel. These tail lights feature a 3-3/4" deep steel housing & a 1-1/2" high X 6" wide billet aluminum face. Dual element bulb for brake/ turn signal & running light. 2.679 -0.15 .. **\$115.25 PR** ⚠



- BIS61330** .....ALL  
Vintage ribbed bezel. With LED bulbs  
2.679 -0.15 ..... **\$150.00 PR** ⚠



- BIS61340** .....ALL  
Smooth bezel. With LED bulbs 2.679 -0.15  
..... **\$150.00 PR** ⚠

**Tail Light Assembly 37-48 LED Black Housing Chevy Car**

Note: 1937-48 Chevy LED tail light assemblies below (4i x 2-3/4i) fit 37-38 cars, 39 w/o trunk & some Sedan Deliveries plus Universal Applications. Choose stainless or black housing.



- 927410EL** .....37-48  
LED. Left. Black housing and chrome rim w/ LED license light. 12V 2.679 -0.15  
..... **\$60.75 EA** ⚠
- 927411ER** .....37-48  
LED. Right. Black housing and chrome rim. 12V ONLY. 2.679 -0.15 **\$46.75 EA** ⚠

**Tail Light Assembly 37-48 LED Stainless Chevy Car**



- 927410FL** .....37-48  
LED. Left. Stainless housing and rim w/ LED license light. 12V 2.679 -0.15  
..... **\$65.25 EA** ⚠
- 927411FR** .....37-48  
LED. Right. Stainless housing and rim. 12 V 2.679 -0.15 ..... **\$51.75 EA** ⚠

**Tail Light Assembly 37-48 LED W/ Blue Dot Chevy Car**



- 927410ELB** .....37-48  
LED. Left. Black housing and chrome rim w/ LED license light. LED blue dot can be lit independently. 12V 2.679 -0.15  
..... **\$66.50 EA** ⚠

**Tail Light Assembly 37-48 LED W/ Blue Dot Chevy Car, cont.**



- 927410FLB** .....37-48  
LED. Left. Stainless housing and rim w/ LED license light. LED blue dot can be lit independently. 12V 2.679 -0.15  
..... **\$75.50 EA** ⚠



- 927411ERB** .....37-48  
LED. Right. Black housing and chrome rim. LED blue dot can be lit independently. 12V ONLY. 2.679 -0.15 ... **\$63.25 EA** ⚠



- 927411FRB** .....37-48  
LED. Right. Stainless housing and rim. LED blue dot can be lit independently. 12 V 2.679 -0.15 ..... **\$72.50 EA** ⚠

**Tail Light Assembly 40-53 LED Black Housing Chevy Truck**

Note: 1940-53 Chevy LED tail light assemblies below (4i x 2-3/4i) fit some 49-52 Sedan Deliveries & Wagons, 40-53 Trucks plus Universal Applications. Choose stainless, chrome or black housing. Flat on back of housing with two mounting studs.



- 927074EL** .....40-53  
Red LED tail light with black housing. White LED license light on bottom of housing. Left side. 12V 2.679 -0  
..... **\$47.00 EA** ⚠
- 985608FR** .....40-53  
Red LED tail light with stainless steel housing. Right hand side. 12V 2.679 -0  
..... **\$46.50 EA** ⚠

**Tail Light Assembly 40-53 LED Chrome Chevy Truck**



- 927074HL**.....**40-53**  
Red LED tail light with chrome housing. White LED license light on bottom of housing. Left side. 12V 2.679 -0.15  
..... **\$54.00 EA** ⚠
- 985608HR**.....**40-53**  
Red LED tail light with chrome housing. Right hand side. 12V 2.679 -0.15  
..... **\$49.99 EA** ⚠

**Tail Light Assembly 40-53 LED Stainless Chevy Truck**



- 927074FL**.....**40-53**  
Red LED tail/ brake light with Stainless steel housing. Left side w/ white LED license light. 12V 2.679 -0.15  
..... **\$59.99 EA** ⚠
- 985608ER**.....**40-53**  
Red LED tail light with black housing. Right hand side. 12V 2.679 -0  
..... **\$41.75 EA** ⚠

**Tail Light Assembly 39-53 LED Chevy**

Note: The 1939-53 tail lights (3" O.D., round) below fit 1939 Chevy cars with trunk, some 1940-48 Chevy Sedan Deliveries, 1949-52 Chevy Wagons with dual tail lights and 47-53 Panels & Suburbans plus Universal applications.



- 916877CLR**.....**39-52**  
CHROME housing w/ Red LED lens. 2.679 -0.15  
..... **\$75.00 EA** ⚠

**Tail Light Assembly 39-53 LED Chevy, cont.**



- 916877CLRC**.....**39-52**  
LED. Red LED, clear lens. Chrome housing w/ Red LEDs. 12V 2.679 -0.15  
..... **\$80.00 EA** ⚠
- 916877LAC**.....**39-52**  
Primered housing w/ Amber LED & clear lens. 12V 2.679 -0.15  
..... **\$80.00 EA** ⚠



- 916877LR**.....**39-52**  
LED. Primer housing w/ Red lens left side. 12V 2.679 -0.15  
..... **\$80.00 EA** ⚠



- 916877LRC**.....**39-52**  
LED. Red LED, clear lens. Primer housing w/ Red LEDs. 12V 2.679 -0.15  
..... **\$80.00 EA** ⚠



- 916878LR**.....**39-52**  
LED. Primer housing w/ Red lens right side. 12V 2.679 -0.15  
..... **\$80.00 EA** ⚠



- 916877CRR**.....**39-53**  
LED. Chrome right housing w/ Red lens. 12V 2.679 -0  
..... **\$75.00 EA** ⚠

**Tail Light Assembly 39-53 LED Chevy, cont.**



- 916877CLA**.....**47-53**  
LED. Chrome housing w/ Amber lens. 12V 2.679 -0.15  
..... **\$80.00 EA** ⚠



- 916877CLAC**.....**47-53**  
LED. Chrome housing w/ Amber LED & clear lens. 12V 2.679 -0.15  
..... **\$80.00 EA** ⚠



- 916877CLR**.....**47-53**  
CHROME housing w/ Red LED lens. 2.679 -0.15  
..... **\$75.00 EA** ⚠



- 916877CLRC**.....**47-53**  
LED. Chrome housing w/ Clear lens & Red LED. 12V 2.679 -0.15  
..... **\$80.00 EA** ⚠



- 916877CRR**.....**47-53**  
LED. Chrome right housing w/ Red lens. 12V 2.679 -0  
..... **\$75.00 EA** ⚠

- 916877LA**.....**47-53**  
LED. Primered housing, amber lens. 12V 2.679 -0.15  
..... **\$80.00 EA** ⚠

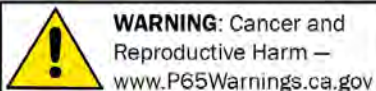

NOTE: Any chemicals will be shipped domestic ground only (Lower 48 states only). No international shipping.

**Tail Light Assembly 39-53 LED Chevy, cont.**



**916877LR** .....47-53  
LED. Primered housing w/ Red LED lens left. 12V 2.679 -0.15 ..... **\$80.00 EA** ⚠



**916877LRC** .....47-53  
LED. Primered housing w/ Red LED & clear lens. 12V 2.679 -0.15 .. **\$80.00 EA** ⚠



**916878LR** .....47-53  
LED. Primered housing w/ Red lens right side. 12V 2.679 -0.15 ..... **\$80.00 EA** ⚠

**Turn Signal Assembly 39 LED Chevy Style**



**916877CLA** .....39-52  
Chrome housing w/ Amber LED & lens. 12V 2.679 -0.15 ..... **\$80.00 EA** ⚠

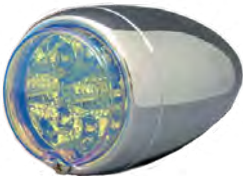

**916877CLAC** .....39-52  
Chrome housing w/ Amber LED & Clear lens. 12V 2.679 -0.15 ..... **\$80.00 EA** ⚠

**Turn Signal Assembly 39 LED Chevy Style, cont.**



**916877LA** .....39-52  
Primered housing, Amber LED & lens. 12V 2.679 -0.15 ..... **\$80.00 EA** ⚠

**Tail Light Assembly 40 LED Chevy**



**927067L** ..... 40  
LED. Chrome rim, black housing & polycarbonate lens. Use for left or right side (reversible lens). 12V 2.679 -0.15 ..... **\$55.00 EA** ⚠



**927067LF** ..... 40  
LED. Flat surface mount. Complete housing with chrome bezels. 12V 2.679 -0.15 ..... **\$115.50 PR** ⚠

**Tail Light Assembly 41-48 LED Chevy**

Note: The following parts are not direct fit for Fleetline 4 door, Sedan Delivery or Wagon. Can be used for Universal Applications.



**927116L** .....41-48  
LED. Right side. Complete assembly w/ stainless rim. 12V. Exc Fleetline 4-door, Sedan Delivery & Wagon. 2.679 -0.15 ..... **\$39.50 EA** ⚠

**Tail Light Assembly 41-48 LED Chevy, cont.**



**927116LC** .....41-48  
LED. Right side, clear lens w/ red LED. Complete assembly w/ stainless rim. 12V. Exc Fleetline 4-door, Sedan Delivery & Wagon. 2.679 -0.15 ..... **\$35.00 EA** ⚠



**927116LF** .....41-48  
LED. Complete assemblies. For applications with a flat surface mount. Stainless rim. 12V. 2.679 -0.15 ..... **\$100.00 PR** ⚠



**927117L** .....41-48  
LED. Left side. Complete assembly w/ stainless rim. 12V. Exc Fleetline 4-door, Sedan Delivery & Wagon. 2.679 -0.15 ..... **\$39.50 EA** ⚠



**927117LC** .....41-48  
LED. Left side, clear lens w/ red LED. Complete assembly w/ stainless rim. 12V. Exc Fleetline 4-door, Sedan Delivery & Wagon. 2.679 -0.15 ..... **\$35.00 EA** ⚠

**Tail Light Assembly 49-50 LED Chevy**



- 927577L**.....**49-50**  
LED. Chrome complete assembly w/  
reflector. Exc SDL & WGN. 12V 2.679 -0.15  
..... **\$105.75 PR** ⚠️
- 927577SL**.....**49-50**  
LED. Stainless complete assembly w/  
reflector. Exc SDL & WGN. 12V 2.679 -0.15  
..... **\$128.75 PR** ⚠️

**Tail Light Assembly 51-52 LED Chevy**



- 927883SL**.....**51-52**  
LED. Complete housing. 12V 2.679 -0.15  
..... **\$65.50 EA** ⚠️

**Tail Light Assembly 1954 LED Chevy**



- 897627L**.....**54**  
Complete assembly with rim, sockets,  
reflector and LED lenses. 2.679 -0.15  
..... **\$170.50 EA** ⚠️

**Tail Light Assembly Ford**



- LEDTL002**.....**38-39**  
Replica of a 38-39 Ford teardrop style tail  
light. Complete unit with housing, stainless  
rim and red LED light. 12V 2.679 -0.15  
..... **\$42.75 EA** ⚠️

**Tail Light Assembly Ford, cont.**



- LEDTL002F**.....**38-39**  
Flat surface mount replica of a 38-39 Ford  
teardrop style tail light. Complete unit with  
housing, chrome rim and 14 red LED  
lights. 5-3/8" tall x 2-9/16" wide. Bolts  
3-9/16" center-to-center. 12V 2.679 -0.15  
..... **\$100.00 L&R** ⚠️



- R9960**.....**38-39**  
1938-39 Ford Tail Light Kit with LED Bulb  
- Red Glass Lens. 12V -0.15 **\$34.25 EA**  
⚠️



- LEDTL003F**.....**40**  
Replica of a 40 Ford "chevron" style tail  
light. Complete unit with housing, triple  
plated chrome rim and red LED lights.  
Includes stainless hardware. 12V  
2.679 -0.15 ..... **\$115.50 PR** ⚠️



- R9977**.....**ALL**  
1938-39 Ford Tail Light Kit - Red Glass  
Lens with Blue Dot. -0.15 ... **\$32.25 EA**  
⚠️



- R9978**.....**ALL**  
1938-39 Ford Tail Light Kit - Red Glass  
Lens. -0.15 ..... **\$30.50 EA** ⚠️

**Tail Light Assembly 38-39 LED Lincoln Zephyr**



- LEDTL014**.....**38-39**  
12v LED Complete assembly -0.15  
..... **\$149.00 PR** ⚠️



- LEDTL015**.....**ALL**  
"Baby Zephyr" mounting pad not  
included. -0.15 ..... **\$44.25 EA** ⚠️



- LEDTL015PAD**.....**ALL**  
Mounting pad for LEDTL15 tail light  
assembly. -0.15 ..... **\$2.75 EA** ⚠️

**Tail Light Assembly LED Plymouth**

Be sure to check out our 46-48 Plymouth LED  
3rd Brake Lights to match these tail lights at  
the end of this section.



- LEDTL005**.....**46-48**  
Flat surface mount LED. Complete  
assemblies. Chrome rim. 12V 2.682 -0.15  
..... **\$115.50 PR** ⚠️

**LED 3rd Brake Light Assembly -Plymouth**



- LEDTL012**.....**46-48**  
1946-48 Plymouth Sedan complete third  
brake light. 2.682 -0.15 ..... **\$200.25 EA** ⚠️



**WARNING: Cancer and Reproductive Harm** —  
www.P65Warnings.ca.gov

NOTE: Any chemicals will be shipped domestic ground only (Lower 48 states only). No international shipping.

**LED 3rd Brake Light Assembly -Plymouth, cont.**



**LEDTL013**.....**46-48**  
1946-48 Plymouth Coupe, complete third brake light. 2.682-0.15 .. **\$199.00 EA** ⚠

**LED Tail Light Assembly - Pontiac**



**LEDTL001**.....**ALL**  
50's Pontiac style. Complete unit with chrome rim and red LED light. Flush mount. 12V 2.679-0.15 .. **\$39.09 EA** ⚠



**LEDTL001S**.....**ALL**  
50's Pontiac style. Complete unit with chrome rim spider style overlay and red LED light. Flush mount. 12V 2.679-0.15 .. **\$47.19 EA** ⚠

**Tail Light Assembly LED 37-42 Willy's**



**LEDTL16**.....**ALL**  
37-42 Willys 22 LED tail light. 37-42 Willys 22 LED tail light. -0.15 .. **\$40.00 EA** ⚠

**LED Tail Light Assembly - 55-59 Chevy Truck**



**897711CL**.....**55-59**  
12 volt. Red LED tail light with stainless housing and pigtail. 2.679-0.15 .. **\$49.59 EA** ⚠

**LED Tail Light Assembly - 55-59 Chevy Truck**



**897711L**.....**55-59**  
Red LED tail light with black housing and pigtail. 12 V 2.679-0.15 .. **\$49.75 EA** ⚠

**LED Bed Roll Lights**



**LEDBEDLITE**.....**ALL**  
LED tail light w/ Aluminum housing in 15/16" (red only), 1-1/8", 1-1/4" or 1-5/8" diameters. Choose Amber or Red. 12V 0.000-0 .. **starting at \$110.00 PR** ⚠



**LEDBEDLITE-RET**.....**ALL**  
LED bed roll light retaining rings for flat panel installations (taillight not included, shown for display purposes only). 0.000-0.15 .. **\$20.99 PR** ⚠



**MAK102864**.....**ALL**  
Red LEDs. Billet aluminum w/ polished bezel. Dual intensity for tail light and brake/ turn signal. Includes 10" pigtail. Fits 40-66 Chevy, 40-87 GMC. 12V. 1-19/32 hole. 0.000-0 .. **\$148.00 PR** ⚠



**MAK102865**.....**ALL**  
19 Amber LEDs. 12V. 1-19/32 hole. 0.000-0 .. **\$148.00 PR** ⚠

**LED Bed Roll Lights, cont.**



**MAK102866**.....**ALL**  
19 White LEDs for back up lights. 12V. 1-19/32 hole. 0.000-0 .. **\$160.00 PR** ⚠

**Tail light - Truck Bed**



**MAK102853**.....**41-66**  
Chevy - Red. Incandescent bulb (amber also available). 0.000-0 .. **\$86.00 PR** ⚠

**Bed Roll Reflector**

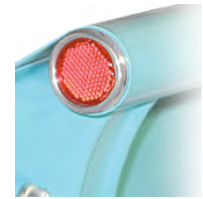

**MAK102850**.....**41-66**  
red insert reflector. 0.000-0.15 .. **\$60.25 PR** ⚠

**Tail Light Lens with Attached LEDs - Chevy**

Note: 1937-53 Chevy tail light parts (4-inch x 2-3/4-inch) below fit 1937-38 cars, 1939 without trunk, some 1940-52 Sedan Delivery & Wagons & 40-53 Chevy trucks. Complete assemblies do not interchange.

Tail lights w/ integrated LEDs. Designed to fit stock housings (unless noted otherwise).



**920626LL**.....**37-52**  
LED conversion. Tail light & license lens w/ integrated LED. LEFT. 12V (must splice wires) 2.682-0.15 .. **\$39.50 EA** ⚠

**Tail Light Lens with Attached LEDs - Chevy, cont.**



**920626LLB** .....**37-52**  
LED conversion. Tail light & license lens w/ integrated LED W/ Blue Dot. LEFT. 12V (must splice wires) 2.682 -0.15  
..... **\$50.00 EA** ⚠



**920626LR** .....**37-52**  
LED conversion. Tail light w/ integrated LED. RIGHT. 12V (must splice wires) 2.682 -0.15  
..... **\$29.00 EA** ⚠



**920626LRB** .....**37-52**  
LED conversion. Tail light w/ integrated LED and blue dot. RIGHT. 12V (must splice wires) 2.682 -0.15  
..... **\$39.50 EA** ⚠



**920626LS** .....**37-52**  
LED conversion. Tail light & license lens w/ integrated LED and sequential turn signals. LEFT. 12V (must splice wires) 2.682 -0.15  
..... **\$47.00 EA** ⚠



**920626RS** .....**37-52**  
LED conversion. Tail light w/ integrated LED with sequential turn signals. RIGHT. 12V (must splice wires) 2.682 -0.15  
..... **\$35.00 EA** ⚠

**Tail Light Lens with Attached LEDs - Chevy, cont.**

**920696CL** ..... **39-53**  
LED fits 3 in. housing. Red. Fits 39-52 car or 47-53 trucks. 12V 2.682 -0.15

..... **\$40.50 EA** ⚠

**920696CLA** ..... **39-53**  
LED fits 3 in. housing. Amber. Fits 39-52 car or 47-53 trucks. 12V 2.682 -0.15

..... **\$40.50 EA** ⚠



**920696L** .....**39-53**  
LED fits 3 in. housing. Red. Fits 39-52 car or 47-53 trucks. 12V 2.682 -0.15

..... **\$34.00 EA** ⚠



**920626LLB** .....**40-53**  
LED conversion. Tail light & license lens w/ integrated LED W/ Blue Dot. LEFT. 12V (must splice wires) 2.682 -0.15

..... **\$50.00 EA** ⚠



**920626LR** .....**40-53**  
LED conversion. Tail light w/ integrated LED. RIGHT. 12V (must splice wires) 2.682 -0.15

..... **\$29.00 EA** ⚠



**920626RS** .....**40-53**  
LED conversion. Tail light w/ integrated LED with sequential turn signals. RIGHT. 12V (must splice wires) 2.682 -0.15

..... **\$35.00 EA** ⚠

**Tail Light Lens with Attached LEDs - Chevy, cont.**



**5931432L** .....**41-48**  
LED tail light. Epoxy coated, fully sealed electronics. 39 super bright LEDs. 12V Exc Fleetline 4-door, Sedan Delivery & Wagon. 2.682 -0.15  
..... **\$29.50 EA** ⚠



**5931432LB** .....**41-48**  
LED tail light with blue dot. Epoxy coated, fully sealed electronics. 37 super bright LEDs. 12V Exc Fleetline 4-door, Sedan Delivery & Wagon. 2.682 -0.15

..... **\$39.50 EA** ⚠



**5937861L** .....**49-50**  
Plastic red tail light lens with 16 red LEDs. 12 volt. 2.682 -0.15  
..... **\$32.75 EA** ⚠



**5940038L** .....**51-52**  
Lens w/ LED lights. Plugs into stock socket. 12V 2.682 -0.15  
..... **\$29.50 EA** ⚠



**5943403L** ..... **53**  
LED. Top turn signal (red). 12V 2.682 -0.15  
..... **\$23.25 EA** ⚠

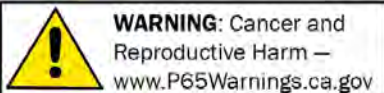

NOTE: Any chemicals will be shipped domestic ground only (Lower 48 states only). No international shipping.

**Tail Light Lens with Attached LEDs - Chevy, cont.**



**5943404L** ..... **53**  
 LED. Backup light lens. 2.697 -0.15  
 ..... **\$40.00 EA** ⚠



**5943406L** ..... **53**  
 LED. Center, Brake/ Marker. 12V 2.682 -0.15  
 ..... **\$29.50 EA** ⚠



**5941679L** ..... **54**  
 LED. Upper lens. 12V 2.682 -0.15  
 ..... **\$33.25 EA** ⚠



**5941699L** ..... **54**  
 LED. PLASTIC  
 backup light w/ lens.  
 2.697 -0.15  
 ..... **\$44.75 EA** ⚠



**5938745L** ..... **55-59**  
 Red LED tail light. Solid state circuit board.  
 (Will not fit stock housing). 12 V 2.682 -0.15  
 ..... **\$33.25 EA** ⚠



**5947161L** ..... **56**  
 1956 Tail Light Lens. Upper plastic lens.  
 12 VOLT ONLY  
 40 leds 2.682 -0.15 ..... **\$32.50 EA** ⚠

**Tail Light Lens with Attached LEDs - Chevy, cont.**



**5947162L** ..... **56**  
 2.697 -0.15 ..... **\$51.75 EA** ⚠



**LEDTL008** ..... **58-59**  
 12 volt. Chevy truck. 2.682 -0.15  
 ..... **\$36.00 EA** ⚠



**LEDTL009** ..... **60-66**  
 12 volt. Chevy truck, Fleetside. 2.682 -0.15  
 ..... **\$38.75 EA** ⚠



**LEDTL010** ..... **60-66**  
 12 volt. Chevy truck stepside. 2.682 -0.15  
 ..... **\$37.00 EA** ⚠

**Tail Light Lens with Attached LEDs - Ford**



**LEDTL011** ..... **38-39**  
 LED lens. -0.15 ..... **\$39.50 EA** ⚠

**Tail Light Lens with Attached LEDs - Ford, cont.**



**LEDTL011B** ..... **38-39**  
 LED Blue Dot lens. Dual Function with Tail  
 Light & Bright Stop/Turn Signal -0.15  
 ..... **\$57.50 EA** ⚠



**LEDTL004** ..... **42-48**  
 Replacement for stock 42-48 Ford cars.  
 12 volt.  
 40 super brite leds  
 epoxy coated, fully sealed electronics  
 solid state circuit board. 2.682 -0.15  
 ..... **\$30.09 EA** ⚠



**LEDTL006** ..... **53-56**  
 Left w/ LED license light. 12V 2.682 -0.15  
 ..... **\$58.00 EA** ⚠



**LEDTL007** ..... **53-56**  
 Right. 12V 2.682 -0.15 ..... **\$34.50 EA** ⚠

**3rd Brake Light -Flush Mount**

Hagan flush mount 3rd brake light kits come complete with housing, bulbs, wiring, lens and sheetmetal panel. All lens widths are 1/2 inch & can be sanded down for a smooth, flush finish.

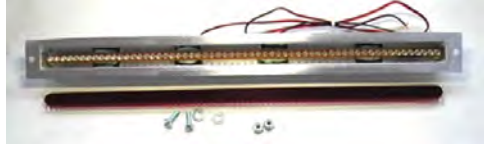

**WASL58BT .....ALL**

3rd Brake Light with Turn Signals This sweet light is split into 3 groups of 15-30-15 providing a 30 LED center 3rd brake light and (2)-15 LED turn signal/brake lights. You can also add our LED Conversion Kits to get taillight and turn/brake or wire them all as one big and bright 3rd brake light. -0.15

**\$139.00 SET** ⚠️

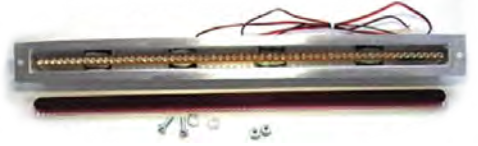

**WASL58BT-SEQ .....ALL**

Get their attention with our Sequencing 60 LED 3rd Brake Light. It's split 10-10-20-10-10 and sequences inside-out once when the brakes are first applied then stays on solid. Flush mounting, build-in lens is 1/2" wide X 15-1/4" long. -0.15

**\$169.25 SET** ⚠️



**WASL58SMB .....ALL**

Small. 30 Super Bright Red LED strips per light. 1/2" wide by 7-1/2" long lens. -0.15

**\$105.25 SET** ⚠️

**Surface Mount Bezel for Flush Mount Lights**



**WASL58-FR .....ALL**

Billet aluminum bezel. 15-1/4". 12V -0.15

**\$60.25 EA** ⚠️



**WASL58SM-FR .....ALL**

Small billet aluminum bezel. 7-1/2".

12V -0.15 **\$52.00 EA** ⚠️

**3rd Brake Light**



**BIS62220 .....ALL**

Oval billet aluminum 3rd brake light. Polished. 7" wide x 1-3/4" high x 1" deep.

2.679 -0.15 **\$46.50 EA** ⚠️



**LED3B1 .....ALL**

LED 3rd brake light with built in turn signals. Billet aluminum. -0.15

**\$50.00 EA** ⚠️



**R9975 .....ALL**

Super Bright LED 3rd Brake Light - 9 5/8" x 5/8". -0.15

**\$22.50 EA** ⚠️

**LED 3rd Brake Light w/ Turn Signals -Pedestal Mount**



**WASL61 .....ALL**

Pedestal 3rd Brake Lights taken to a new level! 16-5/8" wide, 3/4" high (body), 1-1/8" deep and only 2" tall including the swivel base. 60 super bright red LED's are split into 3 groups of 15-30-15 so that you have a 30 LED center 3rd brake light and (2) 15 LED turn signal/ brake lights. You could also add our LED Conversion Kits to get tail light and turn/brake or wire them all as one big and bright 3rd brake light. -0.15

**\$209.25 EA** ⚠️

**LED 3rd Brake Light w/ Turn Signals -Pedestal Mount, cont.**

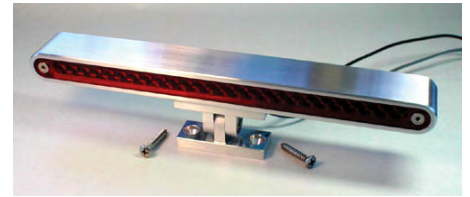

**WASL61SM .....ALL**

8-7/8" wide, 3/4" high (body), 1-1/8" deep and only 2" tall including the swivel base. 30 super bright red LED's.

2 groups of 15-15 provide (2)-15 LED turn signal/brake lights. Or add our LED Conversion Kits to get taillight and turn/brake or wire them all as one 3rd brake light. -0.15

**\$169.00 EA** ⚠️

**LED Tail Lights-Aux Lights**



**5943455AL .....51-52**

Led Lit Reflector Below Tail Light Amber 2.679 -0 **\$15.00 EA** ⚠️



**5943455RL .....51-52**

Led Lit Reflector Below Tail Light Red 2.679 -0.2 **\$14.99 EA** ⚠️

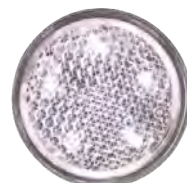

**5943455WL .....51-52**

Led Lit Reflector Below Tail Light White 2.679 -0 **\$15.00 EA** ⚠️

**5606ALED .....ALL**

5 Led Amber Auxiliary Light 2.679 -0.2 **\$15.50 EA** ⚠️

**5606PAD .....ALL**

Auxiliary Light Rubber Pad 2.679 -0.15 **\$1.00 EA** ⚠️

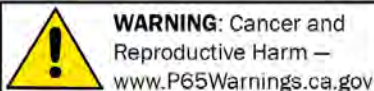

NOTE: Any chemicals will be shipped domestic ground only (Lower 48 states only). No international shipping.



**LED Tail Lights-Aux Lights, cont.**



**5606RLED** .....ALL  
5 Led Red Auxiliary Light 2.679 -0.2  
..... **\$18.25 EA** ⚠



**5606WLED** .....ALL  
5 Led White Auxiliary Light 2.679 -0.2  
..... **\$18.25 EA** ⚠

**Bulbs -LED 6 & 12 Volt**

Note: LEDs are very directional and need to be angled correctly to be bright. Minimal current draw.



**145416ALED6R** .....ALL  
6 Volt Red, offset pin. Replaces bulb #1154. 8.991 -0.2 ..... **\$11.00 EA** ⚠



**145416ALED6W** .....ALL  
6 Volt White, offset pin. Replaces bulb #1154. 8.991 -0.2 ..... **\$15.00 EA** ⚠



**145416J** .....ALL  
12V Amber, offset pins. Replaces bulb #1157. Use LED flasher #3713382L. 8.991 -0.3 ..... **\$9.50 EA** ⚠

**Bulbs -LED 6 & 12 Volt, cont.**



**145416K** .....ALL  
12v Amber, straight pins. Replaces bulb #1156. Use LED flasher #3713382L. 8.991 -0.15 ..... **\$12.25 EA** ⚠



**145416LED6A** .....ALL  
6V Amber, straight pins. single contact Replaces bulb #1156. 8.991 -0.15 ..... **\$15.00 EA** ⚠



**145416LED6R** .....ALL  
6 Volt Red, straight pin. Replaces bulb #1156. 8.991 -0.15 ..... **\$15.00 EA** ⚠



**145416LED6W** .....ALL  
6 Volt White, straight pin. Replaces bulb #1156. 8.991 -0.2 ..... **\$15.00 EA** ⚠



**145416M** .....ALL  
12 Volt Red, straight pin (single contact). Replaces bulb #1156. Use LED flasher #3713382L. 8.991 -0.3 ..... **\$23.25 EA** ⚠

**145416N** .....ALL  
12v Amber, straight pins. Replaces bulb #1156. Use LED flasher #3713382L. 8.991 -0.15 ..... **\$14.99 EA** ⚠

**Blue Dots**



**920626A** .....ALL  
Glass w/ chrome ring (you install). 2.682 -0.15 ..... **\$7.00 PR** ⚠



**920627A** .....ALL  
Chrome with amber Bowtie cut out. 2.682 -0.15 ..... **\$22.19 PR** ⚠



**920627B** .....ALL  
Chrome with blue Bowtie cut out. 2.682 -0.15 ..... **\$22.25 PR** ⚠

# Section 120: Fuel System, Gas Tanks, Gas Tank Sending Units, Fuel Pumps, Carburetors, Air Cleaners & Intake Manifolds

## Air Filter Element



**AIR95F** .....ALL  
Replacement Air Filter For AIR95 3.410 -0.15  
..... **\$16.75 EA** ⚠

Note: Oversize shipping charges apply on all Gas Tanks. Please call for rate.

## Gas Tanks Steel Buick



**21666** .....41-54  
Buick steel gas tank 31-1/2" x 27-1/2" x 7-1/2" 17 Gallons -0.15 .. **\$260.00** ⚠

## Gas Tanks Steel Cadillac



**21667** .....41-47  
Cadillac steel gas tank 30" x 29" x 8" -0.15  
..... **\$349.00** ⚠



**21669** .....48-49  
Cadillac steel gas tank 30x29x8 -0.15  
..... **\$349.00** ⚠



**21670** .....50-53  
Cadillac steel gas tank -0 **\$349.00** ⚠

## Gas Tanks Steel Buick



**21673** .....54-54  
Cadillac steel gas tank -0.15 . **\$349.00**  
⚠



**21676** .....56  
Cadillac gas tank -0 ..... **\$349.00** ⚠



**21678** .....57-58  
1957 Cadillac gas tank also 1958 commercial body (Limo, Hearse) 34x27x8 -0.15 ..... **\$499.00** ⚠



**21681** .....58  
1958 Cadillac gas tank, also fits 1959-68 commercial body (Limo, Hearse) 30.5" x 29.5" x 7.5" -0 ..... **\$499.00** ⚠



**21684** .....59-68  
1959-62 Cadillac gas tank, also fits 1963-68 1963-1968 Cadillac. It holds 4 gallons less than the original for 1963-1968 but this will fit and bolt correctly without any modifications. There will be a 4" void in the underbody cavity of your car that will affect nothing. -0 **\$249.50** ⚠

## Gas Tanks - Stainless Steel - Chevy Cars

**593537** .....37  
Exc 3-passenger Coupe, Sedan Delivery top fill. 3.001-0 ..... **\$887.49 EA** ⚠

## Gas Tanks - Stainless Steel - Chevy Cars, cont.



**3653589** .....  
**37-40**  
Fits 3-passenger Coupe, Sedan Delivery. 40-1/4" x 19-3/4" 5-3/4" tall. 3.001-0  
..... **\$887.50 EA** ⚠

**3653518** .....40  
Exc 3-passenger Coupe, Sedan Delivery. 3.001-0 ..... **\$887.49 EA** ⚠

**3658078** .....41-48  
Fits 3-passenger Coupe & Sedan Delivery. 18 gal. 3.001-0 **\$887.50 EA** ⚠

**3692400** .....47-53  
Stainless steel w/ anti slosh baffle. Fits 47-48 1/2Ton truck & 47-54 1/2Ton Panel. Holds 13.5 gallons. 23-3/4" L x 12-1/2" W x 13" H. 3.001-0  
..... **\$887.49 EA** ⚠

**3694851** .....49-52  
Exc Wagon, Sedan Delivery. 3.001-0  
..... **\$887.49 EA** ⚠

**3698467** .....53-54  
Exc Wagon, Sedan Delivery. 3.001-0  
..... **\$887.49 EA** ⚠



**3702862SS** .....53-54  
Die stamped stainless steel. 3/8" pickup tube with reducer to 5/16" for either 6 or 8 cyl use. Fits Cars (exc. Wagon & Sedan Delivery). Painted silver. 3.001-0.15  
..... **\$269.50 EA** ⚠

**TAI556-SS** .....55-56  
Chevy Car Stainless Steel Gas Tank -0.15  
..... **\$260.00 EA** ⚠

**TAI570-SS** .....57  
Chevy Car Stainless Steel Gas Tank -0.15  
..... **\$260.00 EA** ⚠

## Gas Tanks - Chevy Cars - Steel for Fuel Injection



**3847320F** .....41-48  
Steel tank with provision for fuel injection pump. 16 Gal. 27.5in. x 19.5in. x 7.5in. 3.001-0.15 ..... **\$215.50 EA** ⚠

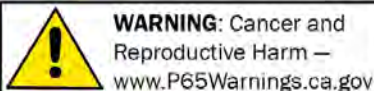

NOTE: Any chemicals will be shipped domestic ground only (Lower 48 states only). No international shipping.

(800) 952-1752 • www.streetrodhq.com

# Section 120: Fuel System, Gas Tanks, Gas Tank Sending Units, Fuel Pumps, Carburetors, Air Cleaners & Intake Manifolds

## Gas Tanks - Chevy Cars - Steel for Fuel Injection, cont.



shown painted for display purposes

**3694851F** .....49-52  
Steel tank with provision for fuel injection pump.16 Gal. 27.5in. x 19.5in. x 7.5in.  
3.001-0.15 ..... **\$210.50 EA** ⚠



**3702862F** .....53-54  
Steel tank with provision for fuel injection pump. 16 Gal. 27.5in. x 19.5in. x 7.5in.  
3.001-0.15 ..... **\$215.50 EA** ⚠

**TAI556-CG** .....55-56  
Chevy Car Gas Tank With Fuel Tray And Recess -0.15 ..... **\$220.00 EA** ⚠

**TAI570-CG** ..... 57  
Chevy Car Gas Tank With Fuel Tray And Recess -0.15 ..... **\$220.00 EA** ⚠

## Gas Tanks - Polyethylene-Chevy Cars

High-Density Polyethylene tanks are built with heavy wall construction. Fits into original location.

Tanks include:

Patented baffle/ tunnel to minimize sloshing  
Pickup tube & vent (top mounted)

Necks located in stock location (no trimming needed)

Fuel-Proof connecting hose

Accepts all 5-hole senders (see sender part #1516250)

(In-tank fuel pumps also available)

Straps



**593537P** ..... 37  
With fill hose, baffle, tunnel & roll over vent valve (exc 3-passenger Coupe & Sedan Delivery), top fill. Requires sending unit #1516250. 3.001-0.15 ..... **\$245.25 EA** ⚠

## Gas Tanks - Polyethylene-Chevy Cars, cont.



**3650116P** .....38-39  
Neck on end (exc 3-passenger Coupe & Sedan Delivery). Requires sending unit #1516250. 3.001-0.15 ..... **\$245.25 EA** ⚠



**3847302PB** .....41-48  
18 gal w/ RIGHT SIDE fill hose, baffle tunnel & roll over vent valve (exc. 3-passenger Coupe & Sedan Delivery).. Requires sending unit #1516250. Tank size 34-1/2" x 18" x 8-1/2" w/o tire well.  
3.001-0.15 ..... **\$260.25 EA** ⚠



**3847320P** .....41-48  
16 gal w/ RIGHT SIDE fill hose, baffle tunnel & roll over vent valve (exc. 3-Passenger Coupe & Sedan Delivery). Requires sending unit #1516250. 28-1/2" x 18" x 8-1/2". 3.001-0.15 ..... **\$250.29 EA** ⚠

**3847320PB** ..... 41-48  
16 gal w/ LEFT SIDE fill hose, baffle tunnel & roll over vent valve (exc. 3-passenger Coupe & Sedan Delivery). Requires sending unit #1516250. 28-1/2" x 18" x 8-1/2". 3.001-0.15 ..... **\$250.00 EA** ⚠

**3847320PL** ..... 41-48  
18 gal w/ LEFT SIDE fill hose, baffle tunnel & roll over vent valve (exc. 3-passenger Coupe & Sedan Delivery). Requires sending unit #1516250. Tank size 34-1/2" x 18" x 8-1/2" w/o tire well.  
3.001-0.15 ..... **\$260.00 EA** ⚠

## Gas Tanks - Polyethylene-Chevy Cars, cont.



**3694851P** .....49-52  
With fill hose drivers side fill w/ baffle tunnel & roll over vent valve (exc 3-Pass Coupe, Sedan Delivery & Wagon). Requires sending unit #1516250.  
3.001-0.15 ..... **\$245.00 EA** ⚠



**3702862P** .....53-54  
With fill hose, baffle tunnel & roll over vent valve (exc Sedan Delivery & Wagon).  
3.001-0.15 ..... **\$270.00 EA** ⚠

## Gas Tanks - Steel - Chevy Cars



**TAI556-A** .....55-56  
Chevy Car Alloy Coated Steel Gas Tank -0.15 ..... **\$150.00 EA** ⚠



**TAI570-A** ..... 57  
Chevy Car Alloy Coated Steel Gas Tank -0.15 ..... **\$150.00 EA** ⚠

## Gas Tanks - Steel Chevy Trucks



**3847690** .....47-53  
Under bed, frame rail mount. Bed fill tank with baffles. 19 gallons. 3.001-0.15 ..... **\$368.50 EA** ⚠

Returns require a return authorization number—Please call first. · Note: Product pricing and availability subject to change.



**WARNING:** Cancer and Reproductive Harm —  
www.P65Warnings.ca.gov

# Section 120: Fuel System, Gas Tanks, Gas Tank Sending Units, Fuel Pumps, Carburetors, Air Cleaners & Intake Manifolds

## Gas Tanks - Steel Chevy Trucks, cont.

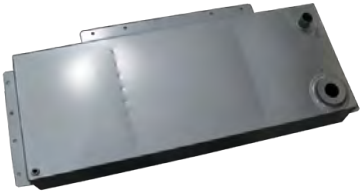

**3708964** ..... **54-55**  
Under bed, frame rail mount. Bed fill tank with baffles. 19 gallons. -0.15  
..... **\$374.00 EA** ⚠

## Gas Tank - Stainless Steel - Ford Cars



**TAI37SS** ..... **37**  
Ford Car Stainless Steel Gas Tank -0.15  
..... **\$440.00 EA** ⚠  
**TAI40SS** ..... **38-40**  
Ford Car Stainless Steel Gas Tank -0.15  
..... **\$440.00 EA** ⚠



**TAITF31C-SS** ..... **55**  
Ford Passenger Car Stainless Steel Gas Tank -0.15 ..... **\$315.00 EA** ⚠



**TAITF31D-SS** ..... **56**  
Ford Passenger Car Stainless Steel Gas Tank -0.15 ..... **\$315.00 EA** ⚠

## Gas Tank - Steel - Ford Cars



**TAI37G** ..... **37**  
Ford Car Alloy Coated Steel Gas Tank -0.15 ..... **\$225.00 EA** ⚠

## Gas Tank - Steel - Ford Cars, cont.



**TAI40G** ..... **38-41**  
1938-40 Ford Car & 38-41 Ford Pickup Alloy Coated Steel Gas Tank -0.15  
..... **\$225.00 EA** ⚠



**TAI48G** ..... **41-48**  
Ford 1941-1948 & Mercury 1939-1948 Alloy Coated Steel Gas Tank -0.15  
..... **\$245.00 EA** ⚠

**TAI49M-G** ..... **49-51**  
Mercury Car Alloy Coated Steel Gas Tank -0.15 ..... **\$230.00 EA** ⚠



**TAI51F** ..... **49-51**  
Ford Car Alloy Coated Steel Gas Tank -0.15  
..... **\$235.00 EA** ⚠



**21690** ..... **56**  
Ford Thunderbird stainless steel gas tank. 29"22"7.5" 17.5 gallons. -0  
..... **\$199.00** ⚠



**TAITF31D** ..... **56**  
Ford Passenger Car Alloy Coated Steel Gas Tank -0.15 ..... **\$210.00 EA** ⚠

## Gas Tank - Steel - Ford Cars, cont.



**21691** ..... **57**  
Ford Thunderbird steel gas tank. 28-7/8" x 22-1/8" x 8-3/4" 20 gallons. -0  
..... **\$189.00** ⚠



**21695** ..... **58-60**  
Ford Thunderbird gas tank 38-1/8" x 20-1/4" x 9" 20 gallons. -0.15  
..... **\$199.00** ⚠



**21696** ..... **61**  
Ford Thunderbird gas tank 33-7/8" x 23-5/8" x 8-3/4" 20 gallons. -0  
..... **\$329.00** ⚠



**21697** ..... **62-63**  
Ford Thunderbird gas tank 33-7/8" x 23-5/8" x 8-3/4" 20 gallons. -0  
..... **\$189.00** ⚠

**B7A9002B** ..... **57-58**  
20 gal. zinc finished steel. Fits all except Sedan Delivery, Station Wagon, Retractable & Ranchero.  
-0.15 ..... **\$250.00 EA** ⚠

**B7AZ9002B** ..... **57-58**  
20 gallon capacity Ni-Terne Steel with filler neck, Fits all except Sedan Delivery, Station Wagon, Retractable & Ranchero. -0.15 ..... **\$220.25 EA** ⚠

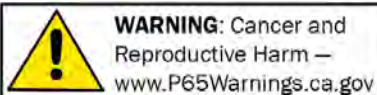

NOTE: Any chemicals will be shipped domestic ground only (Lower 48 states only). No international shipping.

**(800) 952-1752 • www.streetrodhq.com**

**Section 120: Fuel System, Gas Tanks, Gas Tank Sending Units, Fuel Pumps, Carburetors, Air Cleaners & Intake Manifolds**

**Gas Tank - Steel - Ford Cars, cont.**



**B8A9002A** .....57-59  
20 gal. steel gas tank, Ranchero, Wagon & Sedan Delivery. -0 .. \$450.25 EA ⚠  
**B9A9002A1** .....57-59  
Zinc finished steel. An exact reproduction of original factory tank. Fairlane (Retractable Only). -0.15 ... \$289.00 EA ⚠



**B9A9002A** ..... 59  
20 gal. (exc. Retractable, Ranchero & Wagon). -0.15 ..... \$200.00 EA ⚠  
**COAZ9002A** .....60-64  
Galaxie gas tank. -0.15 \$249.00 EA ⚠

**Gas Tanks - Polyethylene-Ford Cars**



**TAI37P** ..... 37  
Passenger cars. 36" x 15" x 10", 17 gallons. -0.15 ..... \$250.00 EA ⚠



**TAI40P** .....38-40  
Passenger cars. 36" x 15" x 10", 17 gallons. -0.15 ..... \$250.00 EA ⚠



**TAI48P** .....39-48  
Fits 41-48 Ford & 39-48 Mercs. 32-1/4" x 18" x 8-1/2", 18 gallons. -0.15 ..... \$250.25 EA ⚠

**Gas Tanks - Polyethylene-Ford Cars**



**TAI51P** .....49-51  
Passenger cars. 24-1/2" x 22-1/2" x 9-1/2", 17 gallons. Great for Universal applications too!. -0.15 \$245.00 EA ⚠

**Gas Tanks Ford Trucks**



**TAIF100** .....53-55  
F-100. 36" x 10-1/2" x 11", 16 gallons. Polyethylene -0.15 ..... \$245.00 EA ⚠



**TAIF100-G** .....53-55  
Ford F-100 Alloy Coated Steel Gas Tank -0.15 ..... \$225.00 EA ⚠

**Gas Tanks - Steel for Dodge & Plymouth Cars**



**48DP-A** .....41-48  
Made in the USA from Aluminized Steel to Protect Against Corrosion.  
- Bolt-on Neck, - Angled Fuel-Proof Connecting Hose, - Accepts All Popular Aftermarket Sending Units (Sender not included).  
- Baffled, - 3/8" ID Nylon Pickup Tube, - Electronically Seam Welded, - Leak tested. -0.15 ..... \$250.50 EA ⚠

**Gas Tank - Steel - Dodge Truck**



**TAI39DP-T** .....39-47  
Dodge Truck Fuel Tank - Steel -0.15 ..... \$260.50 EA ⚠

**Gas Tanks - Polyethylene-Dodge & Plymouth Cars**



**TAI37M** .....37-39  
37-39 Passenger cars. 37" x 18" x 7", 16 gallons. -0.15 ..... \$250.00 EA ⚠

**Gas Tanks Stainless Steel Lincoln**

**21700** .....40-48  
Lincoln stainless steel gas tank. Fits like original. 22 gallons. -0 ..... \$912.49 ⚠

**Gas Tanks - Polyethylene-Universal Truck**

Note: In-Tank electric fuel pumps for poly tanks above are listed after gas tanks.



**605238** .....ALL  
Polyethylene w/ straps. Fits under bed. Universal mount with 3in. neck. 22in. x 17in. x 9.5in. Holds 14 gallons. 3.001-0.15 ..... \$240.25 EA ⚠

**Gas Tanks - Universal Apps**

Note: Oversize shipping applies on all gas tanks. Please call for rates.



**605239** .....ALL  
Fits under bed. Universal mount. 27.75in. x 17.75in. x 8.5in. Holds 16 gallons (strap included). -0.15 ..... \$225.50 EA ⚠

# Section 120: Fuel System, Gas Tanks, Gas Tank Sending Units, Fuel Pumps, Carburetors, Air Cleaners & Intake Manifolds

## Gas Tanks - Universal Apps, cont.

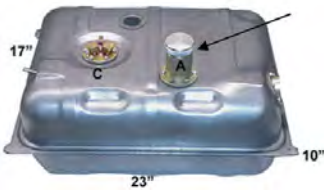

**605239C** .....ALL  
 Top Fill Neck, die-stamped steel under bed/ universal mount tank. 3in. tall neck, billet cap (w/o ring). Baffled and vented. 23in. x 17in. x 10in. w/ 3/4in. flange around. 15 gallons. -0.15 .. **\$220.50 EA**



**605239H** .....ALL  
 Side Fill Neck, die-stamped steel, under bed/ universal mount tank. 2.5in. tall neck w/ 6in. hose. Baffled and vented. 23in. x 17in. x 10in. w/ 3/4in. flange around. 15 gallons. No straps. -0.15 .. **\$220.50 EA**



**605239U1** .....ALL  
 Top Fill Neck, die-stamped steel universal, under bed tank. 2.5 INCH TALL NECK w/ 6in. hose. Baffled and vented. 36in. x 11in. x 10-1/2in. tall w/ 3/4in. flange around. 16 gallons. -0.15 .. **\$215.39 EA**

## Gas Tank Straps



**21672** .....50-53  
 Cadillac tank straps includes pad and bolts -0 ..... **\$40.00** ⚠

## Gas Tank Straps, cont.



**21675** .....54-55  
 Cadillac tank straps includes pad and bolts -0 ..... **\$40.00** ⚠



**21694** .....55-56  
 Ford Thunderbird stainless steel gas tank straps and generic bolts. -0 .. **\$40.00** ⚠



**21677** .....56  
 Cadillac tank straps includes pad and bolts -0 ..... **\$49.00** ⚠



**21680** .....57  
 Cadillac tank straps includes pad and bolts -0 ..... **\$40.00** ⚠



**21693** .....57-59  
 Ford stainless steel straps with pad and generic bolts.  
 Fits: 1957 Thunderbird, 1959 Fairlane, Galaxie, Sunlier, Custom 300. Will not fit retractable. -0.15 ..... **\$40.00** ⚠



**21683** .....58  
 Cadillac tank straps includes pad and bolts -0.15 ..... **\$40.00** ⚠

## Gas Tank Straps, cont.



**21698** .....58-60  
 Ford stainless steel straps with pad and generic bolts. -0 ..... **\$40.00** ⚠



**21687** .....59-68  
 Cadillac tank straps includes pad and bolts -0 ..... **\$40.00** ⚠



**3658213A** .....ALL  
 Universal, no hardware included. 42" L x 1-3/8" W. 3.022 -0.15 ... **\$17.50 PR** ⚠

**B7A9029** .....57-58  
 Stainless steel straps w/ pad & generic bolts. Fairlane, Sunliner, Victoria & '57 Custom, '58 Custom 300 (Exc. Retractable). -0.15 .... **\$40.00 PR** ⚠

**B7A9029R** .....57-59  
 Stainless steel straps w/ pad & generic bolts. Fairlane -Retractible Only. -0.15 ..... **\$40.00 PR** ⚠

**C0A9029** .....60-64  
 Ford, stainless steel straps. Except station wagon -0.15 ..... **\$40.00 PR** ⚠

## Fuel Stabilizers

Keep fuel fresh. Removes water, cleans carburetors & fuel injectors. Protects engine from gum, varnish, rust, and corrosion. Eliminates need to drain fuel before storage. Special dispenser bottles measure exactly without waste. Contains NO alcohol.



**111801** .....ALL  
 STA-BIL stabilizer. 8 oz bottle treats 20 gallons, for one year. 3.001 -0 ..... **\$8.25 EA** ⚠

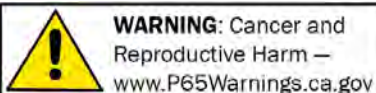

NOTE: Any chemicals will be shipped domestic ground only (Lower 48 states only). No international shipping.

**(800) 952-1752 • www.streetrodhq.com**

# Section 120: Fuel System, Gas Tanks, Gas Tank Sending Units, Fuel Pumps, Carburetors, Air Cleaners & Intake Manifolds

## Fuel Stabilizers, cont.



**111801B** .....ALL  
 STA-BIL fuel stabilizer. 32 oz bottle treats 80 gallons, for one year. 3.001 -0.15  
 ..... \$21.00 EA ⚠

## Gas Tank Restoration Kit



**PORTANK** .....ALL  
 Portank, Restore your tanks. Cleaner, metal prep, sealer (Slosh) and instructions. 3.001 -0.15 . \$84.50 KIT ⚠

## Gas Tank Sealer



**3657942C** .....ALL  
 Gas tank sealer slosh, seals gas tank. Alcohol and Ethanol proof. Not for use with (MEK) Methyl Ethyl Ketone. 3.001 -0.15  
 ..... \$32.25 QT ⚠

## Gas Tank Cleaner



**PORCLEAN** . . . .ALL  
 Porclean, 1 quart. 3.001 -0.15  
 ..... \$11.69 EA ⚠

## Metal Prep



**PORMETAL** . . . .ALL  
 Etches Metal and Leaves a Zinc Phosphate Coating. Provides the best adhesion for POR-15 on any metal surface. Water based,

OSHA approved biodegradable solution. 3.001 -0.15

..... \$16.99 QT ⚠

## Fuel Sending Unit Ohm Converter



**SN34** .....ALL  
 Convert any ohm range fuel level sender to work with any ohm range fuel gauge! -0.15  
 ..... \$136.00 EA ⚠

## Gas Tank Sending Units



**21668** .....41-49  
 Cadillac stainless steel sending unit, with gasket. (Does not fit La Salle) -0.2  
 ..... \$89.00 ⚠



**1516280** .....41-52  
 With gasket, correct ohms for Chev gauges 0-30 (6v or 12v). Exc 49-52 SDL & WGN. 3.107 -0.15  
 ..... \$45.00 EA ⚠



**1518225K** .....41-54  
 With gasket and screws. Correct ohms for Chev gauges. 6v or 12v passenger cars (exc. SDL & WGN). Note: FOR K SERIES TANKS STEEL 18 GAL. 3.107 -0.15  
 ..... \$50.00 EA ⚠



**1518032** .....49-54  
 With gasket, correct ohms for Chev gauges 0-30 (6v or 12v). SDL & WGN only. 3.107 -0.15  
 ..... \$40.00 EA ⚠

## Gas Tank Sending Units, cont.



**21671** .....50-56  
 Cadillac stainless steel sending unit with gasket. 6 or 12 volt. Fits passenger cars. -0.2  
 ..... \$89.00 ⚠



**1518225** .....53-54  
 With gasket, correct ohms for Chev gauges 0-30 (6v or 12v). Pass exc. SDL & WGN. 3.107 -0.15  
 ..... \$40.00 EA ⚠



**1517952** .....54-55  
 0-30 ohms for Chevy gauges (6v or 12v). Brass float. 3.107 -0.15  
 ..... \$40.00 EA ⚠

**21674** .....54-55  
 Cadillac stainless steel sending unit with gasket -0  
 ..... \$45.00 ⚠



**21689** .....55-56  
 Ford / Mercury gas tank sending unit. 10-70 OHMS (When ordering, please specify year.) -0.15  
 ..... \$45.00 ⚠



**21679** ..... 57  
 1957 Cadillac sending unit also fits 1958 commercial body. -0  
 ..... \$89.00 ⚠

# Section 120: Fuel System, Gas Tanks, Gas Tank Sending Units, Fuel Pumps, Carburetors, Air Cleaners & Intake Manifolds

## Gas Tank Sending Units, cont.



**21682** ..... 58  
 1958 Cadillac sending unit also fits  
 1959-68 commercial body. -0.2  
 ..... \$89.00 ⚠



**21685** ..... 59-68  
 Cadillac sending unit single 5/16" line -0  
 ..... \$89.00 ⚠



**21686** ..... 59-68  
 Cadillac sending unit dual 5/16" line -0.4  
 ..... \$280.00 ⚠



**21699** ..... 61-63  
 Ford Thunderbird sending unit with  
 gasket -0.15 ..... \$45.00 ⚠



**TS22SU** ..... 61-63  
 Ford Galaxy sending unit with gasket.  
 73-10ohm -0.15 ..... \$48.99 ⚠



**TAI-GML** ..... 65  
 GM 1965 & Up Fuel Sending Unit - 0-90  
 Ohm -0.15 ..... \$35.00 EA ⚠

## Gas Tank Sending Units, cont.

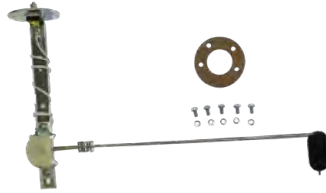

**1516250** ..... ALL  
 W/ screws, gasket & instructions, correct  
 ohms (0-30) for Chevy gauges (6v or 12v).  
 Adjustable float height. 3.107 -0.15  
 ..... \$25.00 EA ⚠



**AUM1-SENDER** ..... ALL  
 Sending unit for 240 Ohm Empty / 33  
 Ohm Full Gauge models. -0.15  
 ..... \$46.50 EA ⚠



**TAI-ORG.** ..... ALL  
 Early Ford & Mopar Up To 1986 Fuel  
 Sending Unit - 73-10 Ohm -0.15  
 ..... \$35.00 EA ⚠



**TAI-VDO** ..... ALL  
 VDO Fuel Sending Unit - 10-180 Ohm -0.15  
 ..... \$35.09 EA ⚠

**B7A9275F** ..... 57-59  
 Ford, complete unit w/ float & gasket, use  
 w/ original gauges, 6v or 12V. (exc.  
 Retractable, Ranchero & Wagon). -0.15  
 ..... \$60.00 EA ⚠

**C2AZ9275D** ..... 60-64  
 Ford, complete unit w/ float & gasket (exc.  
 Station Wagon). -0.15 ..... \$40.00 EA ⚠

## Fuel Pump - Electric (In-Tank) Steel Tanks

High pressure In-Tank fuel pump kits.  
 Adjustable from 7 inch to 10.5 inch deep. No  
 welding required, components bolt together.  
 Constructed with stainless steel reservoir tray,  
 sealed electrical fitting, supply line, return line,  
 vent fitting & In-Tank wiring harness.

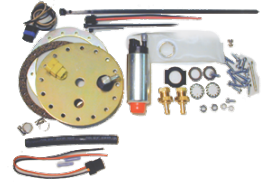

**5591457B** ..... ALL  
 Fits steel tank-deluxe 190 liter per hour  
 pump. 54 gph (gallons per hour) @ 50 psi;  
 32 gph @ 50 psi; 48 gph @ 60 psi.  
 3.900 -0.15 ..... \$210.25 KIT ⚠

**5591457C** ..... ALL  
 Fits steel tank-high flow 250 liter per hour  
 pump. 68 gph (gallons per hour) @ 40  
 psi; 65 gph @ 50 psi; 62 gph @ 60 psi.  
 3.900 -0.15 ..... \$220.25 KIT ⚠

## Fuel Pump - Electric (In-Tank) Poly Tanks

High pressure In-Tank fuel pump kits.  
 Adjustable from 7 inch to 10.5 inch deep. No  
 welding required, components bolt together.  
 Constructed with stainless steel reservoir tray,  
 sealed electrical fitting, supply line, return line,  
 vent fitting & In-Tank wiring harness.

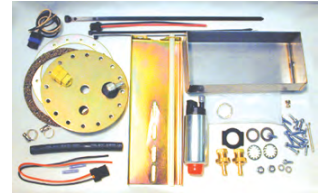

**5591457E** ..... ALL  
 Fits polyethylene tank-deluxe 190 liter per  
 hour pump. 54 gph (gallons per hour) @  
 40 psi; 32 gph @ 50 psi; 48 gph @ 60 psi.  
 3.900 -0.15 ..... \$225.25 KIT ⚠

**5591457F** ..... ALL  
 Fits polyethylene tank-high flow 250 liter  
 per hour pump. 68 gph (gallons per hour)  
 @ 40 psi; 65 gph @ 50 psi; 62 gph @ 60  
 psi. 3.900 -0.15 ..... \$235.25 KIT ⚠

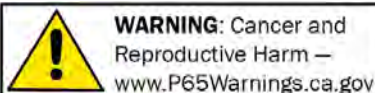

NOTE: Any chemicals will be shipped domestic ground only (Lower 48 states only). No international shipping.

(800) 952-1752 • [www.streetrodhq.com](http://www.streetrodhq.com)



**In Tank Fuel Pickup Unit**



**TANKPU . . . . .ALL**  
Ease the install of a new fuel injection setup. Can be used for carbureted systems also. Includes pump wiring, no-leak mounting gasket, stainless steel

self-tapping mounting screws and lock washers.

NOTE: Use with 3847320K 41-48 gas tank for fuel injection. -0.15

..... **\$53.25 KIT** ⚠

**Fuel Pump -Electric**

**5592627E . . . . .ALL**

Fuel will flow through pump when turned off so pump can be used just to prime or full time. Inline, 6 volt. (30 GPH, 4-6 PSI).

3.900 -0.15 ..... **\$127.00 EA** ⚠



**5593256E . . . . .ALL**

Fuel will flow through pump when turned off so pump can be used just to prime or full time. Inline, 12 volt. (30 GPH, 4-6 PSI).

3.900 -0.15 ..... **\$50.00 EA** ⚠



**5593256F . . . . .ALL**

Intank 12v electric fuel pump rated at 15 GPH and max 3 PSI. 3.900 -0.15

..... **\$68.00 EA** ⚠

**5593256G . . . . .ALL**

This is an Intank 12v electric fuel pump rated at 20-35 GPH and 4-6 PSI.

3.900 -0.15 ..... **\$68.00 EA** ⚠



**5593256H . . . . .ALL**

Intank 12v electric fuel pump rated at 20-35 GPH and 3-5 PSI. 3.900 -0.15

..... **\$68.00 EA** ⚠

**GM LS Engine Fuel Line Kit**



**LSLINEKIT . . . . .ALL**

This fuel line kit includes 25 feet of line and all the fittings that you need for your LS engine swap using our fuel pumps.

This kit is designed for LS engines that have a single fuel inlet fitting. The regulator in this kit is not recommended with fuel pumps that flow over 255 lph. \*\*Please note: the LSLINEKIT will not work with the following tanks.

605239, TAI48G, 3847320F, 3694851F, 3702862F -0.15 ..... **\$235.00 EA** ⚠



**LSLINEKIT45 . . . . .ALL**

This fuel line kit includes 25 feet of line and all the fittings that you need for your LS engine swap using our fuel pumps.

This kit is designed for LS engines that have a single fuel inlet fitting. The regulator in this kit is not recommended with fuel pumps that flow over 255 lph. \*\*Please note: the LSLINEKIT45 is for the following fuel tanks.

605239, TAI48G, 3847320F, 3694851F, 3702862F -0.15 ..... **\$247.00 EA** ⚠

**Fuel Regulator**



**R5857 . . . . .ALL**

Chrome Universal Fuel Regulator with 5/16" & 3/8" Connectors. -0.15

..... **\$39.00 EA** ⚠

**Custom Fuel Door Kits**

Install these unique lids in steel or fiberglass panels with a curved or flat surface, left or right side on fenders, quarter panels or even the cab corner on a 1950 pickup. Spouts at 45 or 90 degree angles from the lid door. Kit includes housing, hinge, door, latch, fill through gas cap (very cool), 4" long spout- 2" dia & pictured instructions. Constructed from 18 gauge mild steel. Push the lid and door pops open.

The screw on gas caps which come with each lid kit are designed to insert the fuel nozzle without removing the cap. This makes filling up easy and keeps the gas lid door size to a minimum.

**Fuel Door Kit - 45 Degree Quarter Panel Series**

The following are slight curved mount.

**HAG450VQP . . . . .ALL**

Oval. Passenger side (hinge on right).

12.944 -0.15 ..... **\$135.00 EA** ⚠

**HAG45RGQ . . . . .ALL**

Rectangular. Drivers side (hinge on left).

12.944 -0.15 ..... **\$135.00 EA** ⚠



**HAG45RQP . . . . .ALL**

Rectangular. Passenger side (hinge on right).

12.944 -0.15 ..... **\$135.25 EA** ⚠



**HAG45RQ . . . . .ALL**

Round. Drivers side (hinge on left).

12.944 -0.15 ..... **\$135.25 EA** ⚠

**HAG45RQP . . . . .ALL**

Round. Passenger side (hinge on right).

12.944 -0.15 ..... **\$135.00 EA** ⚠

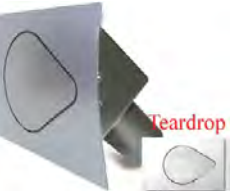

**HAG45TDQ . . . . .ALL**

Teardrop. Drivers side (hinge on left).

12.944 -0.15 ..... **\$135.00 EA** ⚠

# Section 120: Fuel System, Gas Tanks, Gas Tank Sending Units, Fuel Pumps, Carburetors, Air Cleaners & Intake Manifolds

## Fuel Door Kit - 45 Degree Quarter Panel Series, cont.

**HAG45TDQP**..... ALL  
Teardrop. Passenger side (hinge on right).  
12.944 -0.15 ..... \$135.25 EA ⚠

## Fuel Door Kit - 45 Degree Series



**HAG45RC**.....ALL  
Round, curved mount. Drivers side.  
12.944 -0.15 ..... \$135.00 EA ⚠

**HAG45RCP**.....ALL  
Round, curved mount. Passenger side.  
12.944 -0.15 ..... \$135.25 EA ⚠



**HAG45RF**.....ALL  
Round, flat mount. Drivers side. 12.944 -0.15  
..... \$135.25 EA ⚠

**HAG45RFP**.....ALL  
Round, flat mount. Passenger side.  
12.944 -0.15 ..... \$135.25 EA ⚠



**HAG45SC**.....ALL  
Square, curved mount. Drivers side.  
12.944 -0.15 ..... \$135.00 EA ⚠

**HAG45SFP**..... ALL  
Square, flat mount. Passenger side.  
12.944 -0.15 ..... \$135.00 EA ⚠

## Fuel Door Kit - 90 Degree Series

**HAG90BTC**.....ALL  
Bowtie, curved mount. 12.944 -0.15  
..... \$135.00 EA ⚠

**HAG90BTF**..... ALL  
Bowtie, flat mount. 12.944 -0.15  
..... \$135.00 EA ⚠



**HAG90OVC**.....ALL  
Oval, curved mount. 12.944 -0.15  
..... \$135.00 EA ⚠

## Fuel Door Kit - 90 Degree Series, cont.



**HAG90RC**.....ALL  
Round, curved mount. 12.944 -0.15  
..... \$135.25 EA ⚠



**HAG90RF**.....ALL  
Round, flat mount. 12.944 -0.15  
..... \$135.00 EA ⚠



**HAG90RGC**.....ALL  
Rectangular, curved mount. 12.944 -0.15  
..... \$135.00 EA ⚠



**HAG90RGF**.....ALL  
Rectangular, flat mount. 12.944 -0.15  
..... \$135.25 EA ⚠



**HAG90SC**.....ALL  
Square, curved mount. 12.944 -0.15  
..... \$135.00 EA ⚠

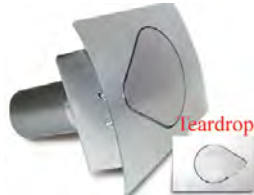

**HAG90TDC**.....ALL  
Teardrop, curved mount. 12.944 -0.15  
..... \$135.00 EA ⚠

## Fuel Door Kit - 90 Degree Series, cont.



**HAG90TDF**.....ALL  
Teardrop, flat mount. 12.944 -0.15  
..... \$135.00 EA ⚠

## Fuel Doors



**ALUMGASDR01**.....ALL  
Rectangular, Ball Milled. Polished billet aluminum. 4-1/4in. x 5-1/2in. 12.944 -0.15  
..... \$109.50 EA ⚠



**ALUMGASDR02**.....ALL  
Rectangular, Smooth. Polished billet aluminum. 4-1/4in. x 5-1/2in. Now with blind mounting holes, no holes show on the front side. 12.944 -0.15  
..... \$94.00 EA ⚠



**ALUMGASDR04**.....ALL  
Oval, Smooth. Polished billet aluminum. 4-1/4in. x 6-1/2in. 12.944 -0.15  
..... \$100.00 EA ⚠

## Gas Caps



**GAS-CAP-STNLS**.....ALL  
Stainless steel, flush cap with retaining chain & key. 3.028 -0.15 .. \$37.00 EA ⚠

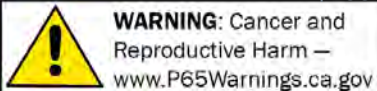

**WARNING:** Cancer and Reproductive Harm — www.P65Warnings.ca.gov

NOTE: Any chemicals will be shipped domestic ground only (Lower 48 states only). No international shipping.

(800) 952-1752 • www.streetrodhq.com

# Section 120: Fuel System, Gas Tanks, Gas Tank Sending Units, Fuel Pumps, Carburetors, Air Cleaners & Intake Manifolds

## Gas Caps, cont.



**KUSC-312521** .....ALL  
Polished Billet Aluminum. 2-1/2" dia. Twist to pop open. -0.15 ..... **\$131.00 EA** ⚠



**TAIAIR** .....ALL  
Polished Aluminum Aircraft Style Gas Cap and Neck  
O-Ring Sealed  
Stainless Chain Tethered Fuel Cap  
Cam Lock Cap is removed by twisting the center tab a quarter of a turn.  
3-3/4" Diameter Outside Diameter Flange  
2-5/8" Overall Length  
5 Bolt Pattern 1/8" Thick Mounting Flange  
2" OD Hose Connection  
Mounting hardware included -0.15  
..... **\$85.25 EA** ⚠



**TAITAC** .....ALL  
Polished aluminum vented cap 3-1/4" diameter. 2-3/4" Bolt Circle Filler Neck with a 3-1/4" Outer Flange  
2" Long Filler Neck with a 2" OD Hose Connection  
Cap will stick up 5/8" when installed -0.15  
..... **\$60.00 EA** ⚠

## Fuel Filler Concealment Kit



**LHRSC** .....ALL  
Hide your fill neck in the bed. Motor lifts a bed wood panel for easy access. All stainless & aluminum hardware, hinges, motor & switch included. 17.438-0  
..... **\$650.25 SET** ⚠

## Fuel Fill Bowl



**605238A** .....ALL  
Flush bed mount, stainless fuel fill bowl for under bed gas tank. 3.001-0.15  
..... **\$33.00 EA** ⚠

## Grommet-Fuel Fill Bowl



**605238C** .....ALL  
Grommet for flush bed mounted fuel fill bowl. 3.001-0.15 ..... **\$7.00 EA** ⚠

## Gas Tank Filler Flange



**3658523S** ....ALL  
Stainless steel filler neck accepts locking or stock gas caps.  
6 inch length, fits 2 inch I.D. hose.  
3.003-0.15  
..... **\$143.00 EA** ⚠

## Induction Systems - Ford

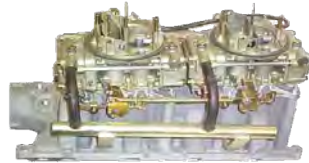

**C1AZ9424ADQ289** .....ALL  
Dual quad manifold w/ 390 CFM Holley carburetors - 289ci & 302ci -0  
..... **\$1,795.00 SET** ⚠



**C1AZ9424ALR24** .....ALL  
Dual quad Low rise Ford manifold w/ New 600 CFM BJ-BK Holley carburetors - 390ci & 427ci -0 ..... **\$2,250.00 SET** ⚠

## Induction Systems - Ford, cont.



**C1AZ9424ATP289** .....ALL  
Tri- Power manifold w/ new 290 CFM Holley carburetors - 289ci & 302ci -0.15  
..... **\$3,500.00 SET** ⚠



**C1AZ9424ATP390** .....ALL  
Tri-power manifold w/ new Holley Carburetors - 390, 406. -0  
..... **\$2,395.00 EA** ⚠

## LS Valley Cover



**BIS95050** .....ALL  
Valley cover for use on LS2, LS3, LS7 & LSX using a carbureted manifold. -0.15  
..... **\$175.00 EA** ⚠

## Intake Manifold - Chevy Big Block



**PP-53000** .....65-90  
RPM range Idle to 6000. Polished. The Power+Plus Cyclone Manifold is a direct replacement manifold for the stock manifold on Chevy big block engines with general duty oval port heads. -0.15  
..... **\$205.00 EA** ⚠



# Section 120: Fuel System, Gas Tanks, Gas Tank Sending Units, Fuel Pumps, Carburetors, Air Cleaners & Intake Manifolds

## Intake Manifold - Chevy Big Block, cont.



**PP-53025**.....**65-90**  
RPM range 1500 to 6500. Polished. Now available for the big block Chevy engine is this terrific Crosswind design manifold. It features oval ports, nitrous bosses, dual distributor hold downs and four corner water ports. This is the ultimate street manifold for 396, 427, 454 or 502 big block engines. It features a raised plenum area that allows air to pass under the plenum, producing a cooler intake charge with a resultant increase in power and torque output. -0.15 .. **\$323.50 EA** ⚠

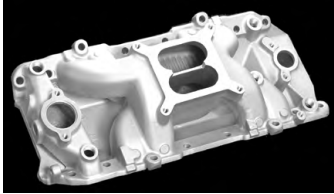

**PP-53026**.....**65-90**  
RPM range 1500 to 6500. Satin. Now available for the big block Chevy engine is this terrific Crosswind design manifold. It features oval ports, nitrous bosses, dual distributor hold downs and four corner water ports. This is the ultimate street manifold for 396, 427, 454 or 502 big block engines. It features a raised plenum area that allows air to pass under the plenum, producing a cooler intake charge with a resultant increase in power and torque output. -0.15 .. **\$254.00 EA** ⚠

## Intake Manifold - Chevy Small Block



**PP-52001**.....**57-95**  
Cyclone, Satin.  
RPM range Idle to 5500

The 52000 Power+Plus Cyclone Manifold is a direct replacement for the stock manifold on 1957-95 Small Block Chevy non-EGR engines. Includes special adapter bushings to fit '87-'95 engines.

Use the stock Quadra-Jet carb or 500-650 cfm vacuum secondary carburetor. Kit includes adapter plate to permit use of certain square bore style carburetors. -0.15

..... **\$130.50 EA** ⚠



**PP-52010**.....**57-95**  
RPM range Idle to 5500. Polished. This is our top-of-the-line medium profile street performance manifold. It is similar to our 52000/52001 Cyclone, although slightly taller, but with several important modifications. First, it has a square bore carb flange instead of a spread bore. The square bore flange permits direct bolt-on of all popular Holley, Edelbrock, Carter, and Demon carburetors. This manifold is also the only SB Chevy manifold available that features a built-in rear water crossover passage. This manifold is also supplied with a quality intake gasket set, 12-point stainless steel attachment bolts, stainless washers, and a full complement of aluminum pipe plugs to plug unused tapped holes. We even include a tube of Permatex Ultra-Black silicone sealer for use on the two ends of the manifold where it seals to the block. -0 .... **CALL** ⚠

## Intake Manifold - Chevy Small Block



**PP-52026**.....**57-95**  
RPM range 1500 to 6500. Satin. The new CrossWind Manifold is a special version of the 52020/52021. While it is the exact same height, it features an open area under the plenum chamber. This provides for a flow of cooling air which keeps the temperature of the air/fuel charge lower thus producing more power and torque. The interior plenum and port design are identical to the 52020/52021 and will provide somewhat better overall power than the 52020/52021 due to the special air gap style design. -0.15

..... **\$210.00 EA** ⚠

## Intake Manifold - Chevy Vortec



**PP-52006**.....**96-01**  
RPM range idle to 5500. Polished. This manifold is based on our most popular manifold, the Performance Street #52000/52001. It is designed to fit engine swaps using the 1996 and later Vortec (Gen 1+) cast iron heads or the Edelbrock E-Tec aluminum heads. These cylinder heads are very popular in street rods, engine swaps, or the industrial market. This manifold can be used on any Chevy V-8 engine utilizing the late Vortec head. -0.15 ..... **\$181.75 EA** ⚠

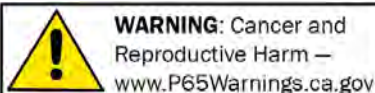

NOTE: Any chemicals will be shipped domestic ground only (Lower 48 states only). No international shipping.

**(800) 952-1752 • www.streetrodhq.com**

**Intake Manifold - Chevy Vortec, cont.**



**PP-52007** .....**96-01**  
 RPM range idle to 5500. Satin. This manifold is based on our most popular manifold, the Performance Street #52000/52001. It is designed to fit engine swaps using the 1996 and later Vortec (Gen 1+) cast iron heads or the Edelbrock E-Tec aluminum heads. These cylinder heads are very popular in street rods, engine swaps, or the industrial market. This manifold can be used on any Chevy V-8 engine utilizing the late Vortec head. -.15  
 ..... **\$141.25 EA** ⚠



**PP-52028** .....**ALL**  
 RPM range 1500 to 6500. Satin. The Power+Plus CrossWind for the Vortec features the same plenum and runner design as our popular 52020/52021 and 52025/52026 manifolds. In this design the manifold is made wider to accommodate the Vortec design heads and also features the Vortec port configuration. The manifold also has a square bore carb pad to utilize the standard Holley, Carter and Edelbrock carburetors. This manifold is intended for use on up through 95 blocks using the 1996 and later Vortec (Gen 1+) heads or Edelbrock E-Tec heads. It can also be used on 96 and later Vortec engines with some minor modifications. -.15  
 ..... **\$185.25 EA** ⚠

**Intake Manifold - Ford Small Block**



**PP-54000** .....**ALL**  
 RPM range 1500 to 6500. The Polished Power+Plus Typhoon Manifold for all 289/302W/5.0L small block Ford engines is a dual plane 180° medium high rise design that delivers outstanding street or race performance across nearly the entire power band while retaining good throttle response at any speed. -.15  
 ..... **\$238.00 EA** ⚠



**PP-54001** .....**ALL**  
 RPM range 1500 to 6500. The Satin Power+Plus Typhoon Manifold for all 289/302W/5.0L small block Ford engines is a dual plane 180° medium high rise design that delivers outstanding street or race performance across nearly the entire power band while retaining good throttle response at any speed. -.15  
 ..... **\$152.75 EA** ⚠



**PP-54026** .....**ALL**  
 RPM range 1500 to 6500. The CrossWind design incorporates an open area under the plenum to allow a full flow of cooling air to pass through. This is similar to features found on single plane racing manifolds and this design can provide more power and torque due to a cooler, more dense intake charge. -.15  
 ..... **\$191.75 EA** ⚠

**Intake Manifold - Mopar**



**PP-55025** .....**ALL**  
 RPM range 1500 to 6500. Polished. This CrossWind manifold is designed so that the same model fits both 318-340-360 engines and the late Magnum V8s. The manifold features an air space under the plenum chamber which allows air to pass through keeping the incoming fuel/air charge cooler than is possible with a conventional design manifold. -.15  
 ..... **\$260.75 EA** ⚠



**PP-55026** .....**ALL**  
 RPM range 1500 to 6500. Satin. This CrossWind manifold is designed so that the same model fits both 318-340-360 engines and the late Magnum V8s. The manifold features an air space under the plenum chamber which allows air to pass through keeping the incoming fuel/air charge cooler than is possible with a conventional design manifold. -.15  
 ..... **\$200.00 EA** ⚠

**Intake Manifold - Pontiac**



**PP-56025** .....**.65-79**  
 RPM range 1500 to 6500. Polished. This is an outstanding high performance street manifold with all the latest manifold design refinements. It features a full open design under the plenum for maximum air circulation to help keep the incoming charge cool for premium power production. It features a spread bore carb flange for those of you who want to run the original Rochester carburetor and we also include a square bore adapter plate and gasket for those who desire a square bore (Holley, Edelbrock, Carter) carburetor. -.15  
 ..... **\$297.75 EA** ⚠

# Section 120: Fuel System, Gas Tanks, Gas Tank Sending Units, Fuel Pumps, Carburetors, Air Cleaners & Intake Manifolds

## Intake Manifold - Ford



**C1AZ9424BT14** .....ALL  
 "Blue Thunder" four barrel. Aluminum intake - 289ci & 302ci -0  
 ..... \$455.00 EA ⚠



**C1AZ9424BT24** .....ALL  
 "Blue Thunder" medium rise dual quad intake - 427ci -0  
 ..... \$1,215.49 EA ⚠



**C1AZ9424C289** .....ALL  
 "Cobra" four barrel. Hi-Rise - 289ci & 302ci -0  
 ..... CALL ⚠  
**C1AZ9424DQ289** .....ALL  
 Hi-Rise dual quad - 289ci & 302ci -0  
 ..... \$475.00 EA ⚠



**C1AZ9424HR14** .....ALL  
 4-bbl. Hi-Rise Replacement for "C4AE-9425-E" - 427ci -0  
 ..... \$595.00 EA ⚠



**C1AZ9424HRTW** .....ALL  
 Hi-Rise tunnel wedge - 427ci -0  
 ..... \$1,850.00 EA ⚠

## Intake Manifold - Ford, cont.



**C1AZ9424LR24** .....ALL  
 Low Rise dual quad intake - 427ci -0  
 ..... \$780.00 EA ⚠



**C1AZ9424MR14** .....ALL  
 "Blue Thunder" medium rise four bbl. Intake - 427ci -0  
 ..... \$575.00 EA ⚠



**C1AZ9424MRTW** .....ALL  
 Medium Rise tunnel wedge - 427ci -0  
 ..... \$975.00 EA ⚠



**C1AZ9424TP390** .....ALL  
 Tri-Power intake - 390 & 406 -0  
 ..... \$825.00 EA ⚠

## Fenton Intake - Dual Carb - Chevrolet



**3687540B** .....50-62  
 Install kit for Fenton intake manifold. Includes bellcrank, throttle rod & spring.  
 3.579-0.15 ..... \$40.09 EA ⚠

## Fenton Intake - Dual Carb - Chevrolet, cont.



**3836071E** .....50-62  
 2 carb intake kit. Includes linkage and fuel kit to install from existing fuel line. For 235ci & 261ci (261ci uses 235ci carbs, w/ 2-15/16" bolt spacing). No grinding required to fit headers. 3.265-0.15  
 ..... \$255.75 EA ⚠

## Offenhauser Intake - Dual Carb - Chevrolet



**3836071B** .....37-53  
 Dual carb. Fits 216ci. Uses 216ci carbs with 2-5/8in. bolt spacing. Linkage included (carb only!). 3.265-0.15  
 ..... \$300.00 SET ⚠

**3836071A** .....50-62  
 Dual carb. Fits 235ci. 261ci uses 235ci carbs with 2-15/16in. bolt spacing. Linkage included (carb only!). 3.265-0.15  
 ..... \$428.75 SET ⚠

## Offenhauser Intake - Triple Carb - Chevrolet



**3836071D** .....37-53  
 Triple carb. Fits 216ci. Uses 216ci carbs with 2-5/8in. bolt spacing. Linkage included (carb only). 3.265-0.15  
 ..... \$310.00 SET ⚠

**3836071C** .....50-62  
 Triple carb. Fits 235ci. 261ci uses 235ci carbs with 2-15/16in. bolt spacing. Linkage included (carb-only). 3.265-0.15  
 ..... \$330.00 SET ⚠

## Heat Kits



**838574B** .....37-53  
 Heat kit. Split headers to intake. 216ci only. 3.640-0.3  
 ..... \$44.25 EA ⚠

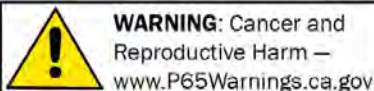

NOTE: Any chemicals will be shipped domestic ground only (Lower 48 states only). No international shipping.

**Section 120: Fuel System, Gas Tanks, Gas Tank Sending Units, Fuel Pumps, Carburetors, Air Cleaners & Intake Manifolds**

**Heat Kits, cont.**



**838573B** .....50-62  
Heat kit. Split headers to intake. 235ci only. 3.640 -0.3 ..... **\$44.25 EA** ⚠

**Carburetor - Ford**

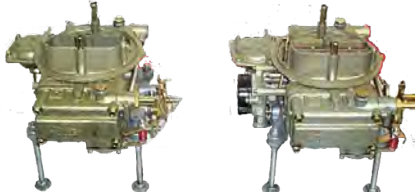

**C1AZ951042724** .....ALL  
2804-2805 Dual Quad Holley carburetors "C3AE-9510-BJ-BK" - 427 -0 ..... **\$1,550.00 SET** ⚠



**C1AZ9510CLC** .....ALL  
New, 3255-1 Lemans carburetor "C5AF-9510-BV" - 427 Cobra NEW -0.15 ..... **\$1,195.00 EA** ⚠



**C1AZ9510SCLC** .....ALL  
3259-1, 289 Shelby Cobra Lemans carburetor "S2MS-A-9510-A" -0 ..... **\$995.00 EA** ⚠



**C1AZ9510TP289** .....ALL  
New, 2881-2882 Tri Power carburetors - 289, 302 & 351 NEW -0 ..... **\$1,395.00 SET** ⚠

**Carburetor - Ford, cont.**



**C1AZ9510TP390** .....ALL  
NEW, 2436-2437 Tri Power carburetors - 390 & 406 -0 ..... **\$1,304.29 SET** ⚠



**C1AZ9A507LBK** .....ALL  
Lemans bowl kits for 289-427 Holley carburetor. -0 ..... **\$118.79 EA** ⚠

**Fuel Log - Ford**



**C1AZ9D280A** .....61-66  
Dual-quad, 390, 406 & 427. Made in USA. Includes 45 degree fitting to fuel line. -0.15 ..... **\$59.50 EA** ⚠



**C1AZ9D280T** .....61-66  
Tri-power - Made in USA. 390, 406 & 427. Includes 45 degree fitting to fuel line. -0.15 ..... **\$59.50 EA** ⚠



**C1AE9D280A** .....63-69  
Tri-power - 390, 406, 427. Includes 45 degree fitting to fuel line. -0.15 ..... **\$59.50 EA** ⚠



**C1AZ9D280** .....63-69  
Dual-quad - 289 & 302. Made in USA. Includes 45 degree fitting to fuel line. -0.15 ..... **\$59.50 EA** ⚠

**Carburetor Spacers**



**R9134** .....ALL  
1" Phenolic Carburetor Spacer with 4-Hole Design (Gaskets Included). -0.15 ..... **\$19.77 EA** ⚠



**R9135** .....ALL  
2" Phenolic Carburetor Spacer with 4-Hole Design (Gaskets Included). -0.15 ..... **\$21.00 EA** ⚠



**R9136** .....ALL  
1" Phenolic Carburetor Spacer with Open Center Design (Gaskets Included). -0.15 ..... **\$19.10 EA** ⚠



**R9137** .....ALL  
2" Phenolic Carburetor Spacer with Open Center Design (Gaskets Included). -0.15 ..... **\$20.50 EA** ⚠



**R9139** .....ALL  
1/2" Phenolic Carburetor Spacer with Open Center Design (Gaskets Included). -0.15 ..... **\$14.75 EA** ⚠

Returns require a return authorization number—Please call first. · Note: Product pricing and availability subject to change.

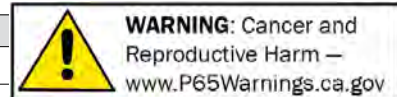

# Section 120: Fuel System, Gas Tanks, Gas Tank Sending Units, Fuel Pumps, Carburetors, Air Cleaners & Intake Manifolds

## Spacer -Carb/ Air Cleaner (Billet Specialties)



**BIS15500-905**.....ALL  
Billet aluminum. 2-1/2" height. Includes fasteners. 3.410 -0.15 ..... **\$57.75 EA** ⚠

## Intake Manifold Gaskets

Feature quality gasket material with silicone beading around the intake ports for additional sealing performance.

(sets do not include end rail gaskets).

## Intake Manifold Gaskets - Chevy Small Block



**PP-52601**.....ALL  
Port Size 1.28" x 2.09" -0.15  
..... **\$14.29 EA** ⚠

**PP-52605**.....ALL  
For Vortec Heads W/ Tapered Ports -0.15  
..... **\$17.50 EA** ⚠

## Intake Manifold Gaskets - Chevy Big Block



**PP-53600** ....ALL  
BB Chevy Oval Ports -0.15  
..... **\$12.25 EA** ⚠

**PP-53601** ....ALL  
BB Chevy Rectangular Ports -0.15  
..... **\$11.00 EA** ⚠

## Intake Manifold Gaskets - Ford Small Block



**PP-54600** ....ALL  
FORD SB (289/302/351/5.0L) -0.15  
..... **\$11.00 EA** ⚠

## Intake Manifold Fitting



**R9515X** .....ALL  
Aluminum Intake Manifold Fitting - 1/2" NPT to 5/8" Barb. -0.15 ..... **\$6.19 EA** ⚠

## Fuel Rail



**GOT103150**... .ALL  
Chrome Plated Universal Fuel Rail  
ó Fits Holley and Demon double pump carburetors and Edelbrock Dual Quad Fuel Systems Completely universal, regardless

of spacers and gaskets One part number fits all! Silver adaptor fits Demon, black adaptor fits Holley, gold adaptor fits Edelbrock. -0.15

..... **\$206.75 SET** ⚠

## Fuel Line Kit



**GOT101110**... .ALL  
Universal fuel line kit for single inlet 2 barrel Holley, 4 barrel Edelbrock or any single inlet carburetor w/ 5/8" -18 or 5/8" -20 thread. -0.15

..... **\$65.75 SET** ⚠



**R2198**.....ALL  
Fuel line. Holley carbs. Chrome, Model 3310. 3/8" tube, 8-21/32" centers. -0.15  
..... **\$15.50 EA** ⚠

## Fuel Filter (Billet Specialties)

Billet Specialties Smooth & Ribbed, polished billet aluminum fuel filters. Choose from -6AN or barbed ends for 3/8" hose.



**BIS42120**.....ALL  
Smooth, polished billet aluminum fuel filter. Barbed ends for 3/8in. hose. 3.890 -0.15 ..... **\$34.39 EA** ⚠



**BIS42220**.....ALL  
Smooth, polished billet aluminum fuel filter for use with -6AN fittings. 3.890 -0.15  
..... **\$34.39 EA** ⚠



**BIS42320**.....ALL  
Ribbed, polished billet aluminum fuel filter. Barbed ends for 3/8in. hose. 3.890 -0.15  
..... **\$34.39 EA** ⚠



**BIS42420**.....ALL  
Ribbed, polished billet aluminum fuel filter for use with -6AN fittings. 3.890 -0.15  
..... **\$34.39 EA** ⚠



**BIS42520**.....ALL  
Filter bracket. Smooth, polished billet aluminum for Billet Specialties fuel filters. 3.890 -0.15 ..... **\$14.89 EA** ⚠



**WARNING:** Cancer and Reproductive Harm — [www.P65Warnings.ca.gov](http://www.P65Warnings.ca.gov)

NOTE: Any chemicals will be shipped domestic ground only (Lower 48 states only). No international shipping.

**(800) 952-1752 • www.streetrodhq.com**



**Fuel Filters**

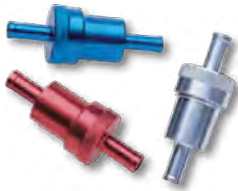

**PP-1020** .....ALL  
 Choose Blue, Red or Brite Aluminum and 2 hose end sizes: 5/16" or 3/8". Washable/replaceable sintered bronze element. -0  
 .....starting at **\$10.50 EA** ⚠



**R9177** .....ALL  
 Chrome Fuel Filter - 3/8" Inlet & Outlet. -0.15 ..... **\$5.50 EA** ⚠



**R9212** .....ALL  
 Chrome Fuel Filter - 5/16" Inlet & Outlet. -0.4 ..... **\$30.00 EA** ⚠



**R9245** .....ALL  
 Chrome/Clear Fuel Filter - 3/8" Inlet & Outlet. -0.2 ..... **\$15.00 EA** ⚠

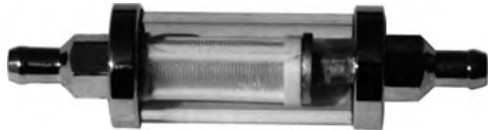

**R9247** .....ALL  
 Chrome/Clear Fuel Filter - 5/16" Inlet & Outlet. -0.15 ..... **\$8.75 EA** ⚠



**R9248** .....ALL  
 Fuel Filter Replacement Kit. -0.15 ..... **\$3.50 EA** ⚠

**Fuel Filters, cont.**



**R9407** .....ALL  
 Chrome Steel Fuel Filter with Bronze Element - 3/8" Inlet/Outlet. -0.15 ..... **\$9.25 EA** ⚠

**Fuel Hose Clamps (Billet Specialties)**

Finish off your engine bay with these beautifully machined clamps. Machined from billet aluminum with a polished finish.



**BIS67025** .....ALL  
 For 5/16in. braided fuel line. Machined from billet aluminum with a polished finish. 1.166 -0 ..... **\$12.00 EA** ⚠

**BIS67225** .....ALL  
 For 3/8in. rubber fuel line. Machined from billet aluminum with a polished finish. 1.166 -0 ..... **\$11.09 EA** ⚠

**BIS67325** .....ALL  
 For 3/8in. braided fuel line. Machined from billet aluminum with a polished finish. 1.166 -0 ..... **\$12.00 EA** ⚠

**Hose Separators - Billet Specialties**



**BIS68020** .....ALL  
 .440 x .540 polished aluminum. 8.950 -0.15 ..... **\$14.00 EA** ⚠

**BIS68025** .....ALL  
 .440 x .630 polished aluminum. 8.950 -0.15 ..... **\$14.00 EA** ⚠

**BIS68120** .....ALL  
 .500 x .500 polished aluminum. 8.950 -0 ..... **\$12.99 EA** ⚠

**BIS68125** .....ALL  
 .540 x .630 polished aluminum. 8.950 -0.15 ..... **\$14.00 EA** ⚠

**BIS68220** .....ALL  
 .562 x .562 polished aluminum. 8.950 -0 ..... **\$12.99 EA** ⚠

**Hose Separators - Billet Specialties, cont.**

**BIS68225** ..... ALL  
 .562 x .625 polished aluminum. 8.950 -0.15 ..... **\$14.00 EA** ⚠

**BIS68320** ..... ALL  
 .625 x .625 polished aluminum. 8.950 -0.15 ..... **\$14.00 EA** ⚠

**BIS68325** ..... ALL  
 .625 x .781 polished aluminum. 8.950 -0 ..... **\$12.99 EA** ⚠

**BIS68420** ..... ALL  
 .734 x .890 polished aluminum. 8.950 -0 ..... **\$12.99 EA** ⚠

**BIS68425** ..... ALL  
 .734 x .969 polished aluminum. 8.950 -0 ..... **\$12.99 EA** ⚠

**BIS68520** ..... ALL  
 .781 x .781 polished aluminum. 8.950 -0 ..... **\$12.99 EA** ⚠

**BIS68525** ..... ALL  
 .781 x .906 polished aluminum. 8.950 -0.15 ..... **\$14.00 EA** ⚠

**BIS68625** ..... ALL  
 .890 x .969 polished aluminum. 8.950 -0.15 ..... **\$14.00 EA** ⚠

**BIS68720** ..... ALL  
 .906 x .906 polished aluminum. 8.950 -0 ..... **\$12.99 EA** ⚠

**BIS68725** ..... ALL  
 .906 x 1.015 polished aluminum. 8.950 -0.15 ..... **\$14.00 EA** ⚠

**BIS68729** ..... ALL  
 .906 x 1.125 polished aluminum. 8.950 -0.15 ..... **\$14.00 EA** ⚠

**BIS68820** ..... ALL  
 .906 x 1.125 polished aluminum. 8.950 -0 ..... **\$12.99 EA** ⚠

**Fuel Pump Block Off (Billet Specialties) -Chevy**

Ball milled, Polished billet aluminum with stainless hardware for Chevy & Chrysler Small & Big Blocks. Includes stainless hardware.



**BIS41120** .....ALL  
 Small block, ball milled block off plate. Polished billet aluminum with stainless hardware. 3.932 -0.15 ..... **\$16.75 EA** ⚠

# Section 120: Fuel System, Gas Tanks, Gas Tank Sending Units, Fuel Pumps, Carburetors, Air Cleaners & Intake Manifolds

## Fuel Pump Block Off (Billet Specialties) -Chevy, cont.



**BIS41220**.....ALL  
Big block, ball milled block off plate. Polished billet aluminum with stainless hardware. 3.932-0.15 ..... **\$16.75 EA** ⚠

## Fuel Pump Block Off (Billet Specialties) -Chrysler



**BIS41820**.....ALL  
Small block, ball milled block off plate. Polished billet aluminum with stainless hardware. -0.15 ..... **\$16.00 EA** ⚠



**BIS41825**.....ALL  
Big block, ball milled block off plate. Polished billet aluminum with stainless hardware. -0.15 ..... **\$16.00 EA** ⚠

## Fuel Pump Block Off (RPC) -Chevy



**R6257**.....ALL  
Polished Aluminum SB Chevy Fuel Pump Block-Off Plate. -0.15 ..... **\$14.50 EA** ⚠



**R6258**.....ALL  
Polished Aluminum BB Chevy Fuel Pump Block-Off Plate. -0.15 ..... **\$12.49 EA** ⚠

## Throttle Cables (Lokar)

Lokar cables are designed with a specially extruded liner for extended life of the cable. Cables are equipped with aluminum fitting and aluminum ferrule to eliminate fraying. Adapts to factory and aftermarket pedals.



**TC-1000HT**.....ALL  
Hi-Tech. 24in. w/ braided stainless steel sleeve. 3.450-0.15 ..... **\$61.50 EA** ⚠

**TC-1000HT36**.....ALL  
Hi-Tech. 36in. w/ braided stainless steel sleeve. 3.450-0.15 ..... **\$66.00 EA** ⚠



**TC-1000TP**.....ALL  
For Tuned port inject. Hi-Tech, 24in. braided stainless steel sleeve. 3.450-0.15 ..... **\$59.69 EA** ⚠



**TC-1000U**.....ALL  
Universal. 24in. w/ black sleeve. 3.450-0.15 ..... **\$47.50 EA** ⚠

**TC-1000U36**.....ALL  
Universal. 36in. w/ black sleeve. 3.450-0.15 ..... **\$60.75 EA** ⚠

## Throttle Cables



**R6054**.....ALL  
Braided Stainless Universal Throttle Assembly - 24" Housing with Cable. -0.15 ..... **\$45.50 EA** ⚠

**R6054X**.....ALL  
Braided Stainless Universal Throttle Assembly - 36" Housing with Cable. -0.15 ..... **\$45.50 EA** ⚠

## Throttle Cable Brackets



**R9620**.....ALL  
Chrome 2bbl/4bbl Adjustable Throttle Cable Bracket with Automatic Trans Kickdown. -0.15 ..... **\$13.00 EA** ⚠



**SRK-4000**.....ALL  
Stainless bracket & GM designed dual stainless springs are used to mount Lokar's throttle cable & kick down assemblies. Includes tension screw to prevent bracket from movement under extreme pressure on a kick down cable. 3.450-0.15 ..... **\$32.50 EA** ⚠

## Throttle Return Spring



**R6052**.....ALL  
Chrome Universal Dual Throttle Return Spring Kit. -0.15 ..... **\$7.25 EA** ⚠

**R6052X**.....ALL  
Stainless Universal Dual Throttle Return Spring Kit. -0.15 ..... **\$8.50 EA** ⚠



NOTE: Any chemicals will be shipped domestic ground only (Lower 48 states only). No international shipping.

**(800) 952-1752 • www.streetrodhq.com**

# Section 120: Fuel System, Gas Tanks, Gas Tank Sending Units, Fuel Pumps, Carburetors, Air Cleaners & Intake Manifolds

## Tune Port Bracket (Lokar)

Billet aluminum bracket mounts to the side of the Tune-Port plenum. Bracket is available with a single stud for throttle only or double stud for throttle & kickdown cable.



**TCB-40TP1** .....ALL  
Single stud. 3.700 -0.15 .. \$48.95 EA  
⚠



**TCB-40TP2** .....ALL  
Double stud. 3.700 -0.15 . \$48.95 EA  
⚠

## Air Cleaner Assembly Oval (Billet Specialties) - Streamline Series



**BIS15324** .....ALL  
Black Finish. Small Oval. 3.410 -0.15  
..... \$195.00 EA ⚠



**BIS15324RTF** .....ALL  
We Prepped It... You Paint It. Small Oval  
3.410 -0.15 ..... \$195.00 EA ⚠



**BIS15424** .....ALL  
Black Finish. Large Oval. 3.410 -0.15  
..... \$210.00 EA ⚠

## Air Cleaner Assembly Oval (Billet Specialties) - Streamline Series, cont.



**BIS15424RTF** .....ALL  
We Prepped It... You Paint It. Large Oval  
3.410 -0.15 ..... \$210.00 EA ⚠

## Air Cleaner Assembly Round (Billet Specialties) - Streamline Series



**BIS15824** .....ALL  
14" Round. 3.410 -0.15 . \$265.00 EA ⚠



**BIS15824RTF** .....ALL  
14" Round. 3.410 -0.15 . \$265.00 EA ⚠

## Air Cleaner Assembly Oval (Billet Specialties)

Note: Billet Specialties air cleaners finish off your motor like no other. Fits standard 4-barrel carbs. CNC machined from 6061 T-6 billet aluminum with a polished finish. Comes with filter element which can be purchased at most automotive stores. Dual Quad air filters also available. Don't forget to pick out matching engine accessories: Valve Covers, Breathers & Wire Looms Sect 20; Radiator Caps Sect 30.

Note: Small air cleaner size: 11-7/8" L x 8-3/8" W x 3" H.

Note: Large air cleaner size: 15" L x 8-1/2" W x 3" H.



**BIS15327** .....ALL  
Cross Flags, polished top plate. Small oval.  
3.410 -0.15 ..... \$132.00 EA ⚠

## Air Cleaner Assembly Oval (Billet Specialties), cont.



**BIS15329** .....ALL  
Smooth, polished top plate. Small oval.  
3.410 -0.15 ..... \$126.00 EA ⚠



**BIS15420** .....ALL  
Ball milled, polished top plate. Large oval.  
3.410 -0.15 ..... \$137.25 EA ⚠



**BIS15427** .....ALL  
Cross Flags, polished top plate. Large oval.  
3.410 -0.15 ..... \$143.00 EA ⚠



**BIS15429** .....ALL  
Smooth, polished top plate. Large oval.  
3.410 -0.15 ..... \$137.00 EA ⚠



**BIS15630** .....ALL  
Ribbed, polished top plate. Small oval with raised ball-milled ribs. 3.410 -0.15  
..... \$160.25 EA ⚠

**Section 120: Fuel System, Gas Tanks, Gas Tank Sending Units, Fuel Pumps, Carburetors, Air Cleaners & Intake Manifolds**

**Air Cleaner Assembly Oval (Billet Specialties), cont.**



**BIS15640**.....ALL  
Ribbed, polished top plate. Large oval with raised ball-milled ribs. 3.410 -0.15  
..... \$171.00 EA ⚠

**Air Cleaner Assembly Triangle (Billet Specialties)**



**BIS15729**.....ALL  
Triangle, smooth. K&N filter included. 14-7/8"L X 13-1/2"W X 3-1/8"H. 3.410 -0.15  
..... \$254.25 EA ⚠

**Air Cleaner Assembly Round (Billet Specialties)**



**BIS15229**.....ALL  
Smooth, polished top plate. 10 inch, round. 3.410 -0.15  
..... \$116.25 EA ⚠



**BIS15820**.....ALL  
Ball milled, polished top plate. 14 inch, round. Features 1 inch drop base for extra hood clearance. 3.410 -0.15  
..... \$170.00 EA ⚠

**Air Cleaner Assembly Round (Billet Specialties), cont.**



**BIS15829**.....ALL  
Smooth, polished top plate. 14 inch, round. Features 1 inch drop base for extra hood clearance. 3.410 -0.15  
..... \$170.00 EA ⚠

**Air Cleaner Assembly**



**R7148**.....ALL  
Chrome 14" x 3" Triangular Style Air Cleaner Set - Paper Element & Flat Base -0.15  
..... \$40.79 EA ⚠

**Air Cleaner Assembly - "Shotgun"**



**R5234**.....ALL  
Finned "Shotgun" style intake scoop for dual quad or single quad applications. Includes bases, filters, scoop & mounting hardware. -0.15  
..... \$280.00 SET ⚠

**Air Scoop**



**R5239**.....ALL  
Polished Aluminum "Finned" Street Scoop with Paper Element - Dual Quad (Round Flaps). -0.15  
..... \$286.00 EA ⚠



**R5350**.....ALL  
Polished Aluminum "Finned" Street Scoop with Paper Element - Dual Quad (Square Flaps). -0.15  
..... \$306.25 EA ⚠

**Air Scoop, cont.**



**R5351**.....ALL  
Polished Aluminum "Plain" Street Scoop with Paper Element - Dual Quad (Square Flaps). -0.15  
..... \$306.25 EA ⚠

**Air Cleaner - Olds/ Cadillac**



**8500-TNS**.....ALL  
Based on the original 50s Olds & Caddy air cleaners, this retro style, all steel air cleaner will look at home on any street rod or "period perfect" car. Measuring 18-1/4" wide, it uses the same external dimensions as the original Olds oil-bath unit but uses an off-the-shelf 14" dia., 4" tall paper filter element. Powder coated in a tough, semi-gloss black finish. 3.410 -0.15  
..... \$129.00 EA ⚠



**8500C**.....ALL  
Based on the original 50s Olds & Caddy air cleaners, this retro style, all steel air cleaner will look at home on any street rod or "period perfect" car. Measuring 18-1/4" wide, it uses the same external dimensions as the original Olds oil-bath unit but uses an off-the-shelf 14" dia., 4" tall paper filter element. Chrome finish. 3.410 -0.15  
..... \$199.00 EA ⚠

**Air Cleaner Assembly -Single Barrel Carb**



**1528725L**....ALL  
Louvered. Complete w/ 4in. filter and base clamp. 3.410 -0.15  
..... \$12.75 EA ⚠

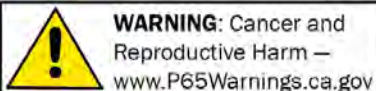

NOTE: Any chemicals will be shipped domestic ground only (Lower 48 states only). No international shipping.

# Section 120: Fuel System, Gas Tanks, Gas Tank Sending Units, Fuel Pumps, Carburetors, Air Cleaners & Intake Manifolds

## Air Cleaner Assembly -Single Barrel Carb, cont.



**1528725ML . . .ALL**  
Complete with 4in. filter, chrome louvered housing, base clamp & 3 prong spinner. Smooth housing. 2-5/8in. neck. 3.410 -0.15



**1528725MS . . .ALL**  
Complete with 4in. filter, base clamp & 3 prong spinner. Smooth housing. 2-5/8in. neck. 3.410 -0.15



**1528725S . . .ALL**  
Smooth. Complete w/ 4in. filter and base clamp. 3.410 -0.15



**AIR95 . . . . .ALL**  
Stellings & Hellings 9-1/2" dia. Stainless steel. Complete w/ filter and base clamp. Fits carbs with 2-1/4" top. 3.410 -0.15

## Air Cleaner Assembly Adapter



**1528725A . . . . .ALL**  
2-5/8in. to 2-5/16in to fit air cleaners. 3.410 -0.2

## Air Filter Element



**1528725E . . . . .ALL**  
4 in. replacement for air cleaner assemblies (#1528725S, 1528725L, 1528725ML and 1528725MS). 3.410 -0.2

## Air Cleaner Clamp



**1528725C . . . . .ALL**  
Replacement for base of 4in. air cleaner (#1528725S & #1528725L). 3.410 -0.15

## Air Cleaner

**OTB-4750 . . . . .ALL**  
Finned Unpolished Fits 2-1/4" Rochester, Carter, Zenith Carbs -0 .. \$145.25 EA

**OTB-4750P . . . . .ALL**  
Finned Polished Fits 2-1/4" Rochester, Carter, Zenith Carbs -0 .. \$169.50 EA

**OTB-4760 . . . . .ALL**  
Mini Mohawk Unpolished Fits 2-1/4" Rochester, Carter, Zenith Carbs -0 .. \$145.25 EA

**OTB-4760P . . . . .ALL**  
Ribbed Edge Polished Fits 2-1/4" Rochester, Carter, Zenith Carbs -0 .. \$169.00 EA

**OTB-4770 . . . . .ALL**  
Mini Mohawk Unpolished Fits 2-1/4" Rochester, Carter, Zenith Carbs -0 .. \$145.25 EA

**OTB-4770P . . . . .ALL**  
Mini Mohawk Polished Fits 2-1/4" Rochester, Carter, Zenith Carbs -0 .. \$169.50 EA



**OTB-S4 . . . . .ALL**  
Finned with domed top. Includes 2" tall "Platinum Series" filter. Precision bored for snug fit. Choose carb type and finish (polished or unpolished). -0.15



**OTB-S4001 . . . . .ALL**  
Short. Fits #OTB-S4. Stainless mesh with quality gaskets. -0.15

## Air Cleaner, cont.

**OTB-S4120 . . . . .ALL**  
Finned polished aluminum. For 94, 97 & 98 Carbs -0.15 .. \$85.00 EA



**OTB-S4220 . . . . .ALL**  
Finned polished aluminum. For Rochester 2-G Carbs -0.15 .. \$83.75 EA



**OTB-S4320 . . . . .ALL**  
Finned polished aluminum. For 3-1/16" Rochester Carbs -0.15 .. \$80.00 EA



**OTB-S4325 . . . . .ALL**  
Finned unpolished aluminum. For 3-1/16" Rochester Carbs -0.15 .. \$80.00 EA



**OTB-T4002 . . . . .ALL**  
Tall. Fits #OTB-T4. Stainless mesh with quality gaskets. -0.15 .. \$27.00 EA

## Air Cleaner Nut



**PCW1500V . . . . .ALL**  
Machined aluminum, brushed finish. 1/4"-20 Thread. -0.15 .. \$20.00 EA

Returns require a return authorization number—Please call first. · Note: Product pricing and availability subject to change.

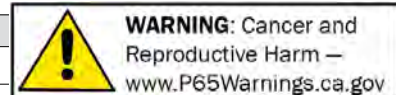

# Section 120: Fuel System, Gas Tanks, Gas Tank Sending Units, Fuel Pumps, Carburetors, Air Cleaners & Intake Manifolds

## Air Cleaner Nut, cont.



**PCW1500VB** .....ALL  
Machined aluminum, black anodized finish.  
1/4"-20 Thread. -0.15 .. \$25.00 EA ⚠

## MAG DADDY - Universal Magnetic Clips



**MDU-CABLEB** .....ALL  
Mag Daddy Universal magnetic cable clip black - 5 pack. Great for holding cables anywhere you can stick a magnet.  
8.950 -0.15 ..... \$12.50 SET ⚠



**MDU-CABLEMD** .....ALL  
Mag Daddy Universal magnetic cable clip black - 3 pack. Great for holding cables anywhere you can stick a magnet.  
8.950 -0.15 ..... \$7.50 SET ⚠



**MDU-CABLEW** .....ALL  
Mag Daddy Universal magnetic cable clip white - 5 pack. Great for holding cables anywhere you can stick a magnet.  
8.950 -0.15 ..... \$9.75 SET ⚠



**MDU-STARTERKIT** .....ALL  
Mag Daddy Universal Starter Kit  
8.950 -0.15 ..... \$77.29 SET ⚠

## MAG DADDY - Universal Magnetic Clips



**MDU-WIREKITB** .....ALL  
Mag Daddy Universal Wire / Cable Kit. Black. Great for holding cables anywhere you can stick a magnet. 8.950 -0 ..... \$74.99 SET ⚠



**MDU-WIREKITW** .....ALL  
Mag Daddy Universal Wire / Cable Kit. White 8.950 -0.15 ..... \$75.00 SET ⚠



**MDU-ZIPB** .....ALL  
Mag Daddy Universal magnetic zip clip black - 5 pack. Great for holding cables anywhere you can stick a magnet. For use with zip ties. 8.950 -0.15 ... \$12.49 SET ⚠



**MDU-ZIPW** .....ALL  
Mag Daddy Universal magnetic zip clip white - 5 pack. Great for holding cables anywhere you can stick a magnet. For use with zip ties. 8.950 -0.15 ... \$12.49 SET ⚠

## Clamps



**120521** .....ALL  
1/4 in. bolt-on strap. For wire or tube (4 pcs). 8.950 -0.4 ..... \$2.59 SET ⚠

## Clamps, cont.



**120521A** .....ALL  
5/16 in, insulated bolt-on strap. For wire or tube (4 pcs). 8.950 -0.4 ..... \$3.29 SET ⚠



**120521B** .....ALL  
3/8 in. bolt-on strap. For wire or tube (4 pcs). 8.950 -0.4 ..... \$2.79 SET ⚠

## Line Clamps - Billet Specialties



**BIS65110** .....ALL  
3/16" single (4 clamps). 8.950 -0.15 ..... \$12.25 SET ⚠

**BIS65210** .....ALL  
1/4" single (4 clamps). 8.950 -0 ..... \$11.09 SET ⚠

**BIS65310** .....ALL  
5/16" single (4 clamps). 8.950 -0.15 ..... \$12.25 SET ⚠

**BIS65410** .....ALL  
3/8" single (4 clamps). 8.950 -0 ..... \$12.00 SET ⚠



**BIS65510** .....ALL  
1/2" single (4 clamps). 8.950 -0 ..... \$12.99 SET ⚠

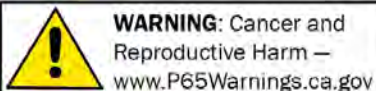

**WARNING:** Cancer and Reproductive Harm — [www.P65Warnings.ca.gov](http://www.P65Warnings.ca.gov)

NOTE: Any chemicals will be shipped domestic ground only (Lower 48 states only). No international shipping.

(800) 952-1752 • [www.streetrodhq.com](http://www.streetrodhq.com)

**Line Clamp - Stainless**



- 13274**.....**ALL**  
3/16" single (12 clamps). 8.950 -0.15  
..... **\$17.00 SET** ⚠
- 13277**..... **ALL**  
1/4" single (12 clamps). 8.950 -0.15  
..... **\$16.99 SET** ⚠
- 13278**..... **ALL**  
5/16" single (12 clamps). 8.950 -0.15  
..... **\$18.25 SET** ⚠
- 13279**..... **ALL**  
3/8" single (12 clamps). 8.950 -0.15  
..... **\$18.25 SET** ⚠
- 13280**..... **ALL**  
1/2" single (12 clamps). 8.950 -0.15  
..... **\$16.99 SET** ⚠
- 13281**..... **ALL**  
5/8" single (8 clamps). 8.950 -0.15  
..... **\$16.99 SET** ⚠
- 13282**..... **ALL**  
3/4" single (8 clamps). 8.950 -0.15  
..... **\$16.99 SET** ⚠
- 13283**..... **ALL**  
7/8" single (8 clamps). 8.950 -0.15  
..... **\$16.99 SET** ⚠



- 13285**.....**ALL**  
1/4" x 1/4" double (6 clamps). 8.950 -0.15  
..... **\$17.00 SET** ⚠
- 13288**..... **ALL**  
1/2" x 1/2" double (6 clamps). 8.950 -0.15  
..... **\$16.99 SET** ⚠
- 13275**..... **ALL**  
3/16" x 3/8" double combination (6  
clamps). 8.950 -0.15 ..... **\$17.00 SET** ⚠
- 13276**..... **ALL**  
3/16" x 3/16" double (6 clamps).  
8.950 -0.15 ..... **\$17.00 SET** ⚠
- 13284**..... **ALL**  
5/16" x 3/8" double combination (6  
clamps). 8.950 -0.15 ..... **\$16.99 SET** ⚠
- 13286**..... **ALL**  
5/16" x 5/16" double (6 clamps).  
8.950 -0.15 ..... **\$17.00 SET** ⚠
- 13287**..... **ALL**  
3/8" x 3/8" double (6 clamps). 8.950 -0.15  
..... **\$17.00 SET** ⚠
- 13289**..... **ALL**  
5/8" x 5/8" double (4 clamps). 8.950 -0.15  
..... **\$17.00 SET** ⚠

**Line Clamp - Stainless, cont.**

- 13290**..... **ALL**  
3/4" x 3/4" double (4 clamps). 8.950 -0.15  
..... **\$17.00 SET** ⚠
- 13291**..... **ALL**  
7/8" x 7/8" double (4 clamps). 8.950 -0.15  
..... **\$16.99 SET** ⚠

**Dual Exhaust System - Chevy Car**

Nothing can beat the sound of the "Split Six" Dual Exhaust! This complete dual exhaust system has been designed for the do-it-yourselfer, and can be installed right in your own backyard or garage. All exhaust pipes are pre-bent, to fit and are made of aluminized tubing for long lasting life. William's Exhaust Headers will improve performance, and glass packed mufflers will give your car the sound made famous in the 50's. Complete with all necessary hardware and installation instructions, (Clamps, hangers, donuts, etc.)

Made in the USA

Note: Headers must be drilled and tapped to use heat kits 838573B or 838574B. Used to heat intake in cold climates (not required).

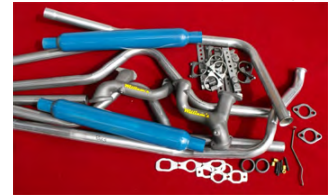

- 2018DUAL** ..... **41-48**  
Standard Transmission Exc. Conv. -0.15  
..... **\$695.00 EA** ⚠
- 2019DUAL** ..... **49-52**  
Standard Transmission Exc. Conv. -0.15  
..... **\$695.00 EA** ⚠
- 2020DUAL** ..... **50-52**  
Automatic Exc. Conv. -0.15  
..... **\$695.00 EA** ⚠
- 2021DUAL** ..... **53-54**  
Standard Transmission Exc. Conv. -0.15  
..... **\$695.00 EA** ⚠
- 2022DUAL** ..... **53-54**  
Exhaust System- Complete Aluminized  
Dual System (Automatic) Exc. Conv. -0.15  
..... **\$695.00 EA** ⚠
- 2023DUAL** ..... **55-57**  
Standard Transmission Exc. Conv. -0.15  
..... **\$695.00 EA** ⚠
- 2024DUAL** ..... **55-57**  
Automatic Transmission Exc. Conv. -0.15  
..... **\$695.00 EA** ⚠
- 2025DUAL** ..... **58**  
Standard Transmission Exc. Conv. -0.15  
..... **\$695.00 EA** ⚠
- 2026DUAL** ..... **58**  
Automatic Transmission Exc. Conv. -0.15  
..... **\$695.00 EA** ⚠
- 2027DUAL** ..... **59-60**  
Standard Transmission Exc. Conv. -0.15  
..... **\$695.00 EA** ⚠
- 2028DUAL** ..... **59-60**  
Automatic Transmission Exc. Conv. -0.15  
..... **\$695.00 EA** ⚠

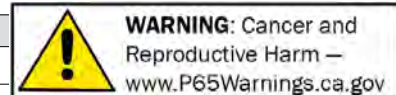

# Section 130: Exhaust Systems, Headers, Extensions

## Dual Exhaust System - Chevy Car, cont.

<b>2029DUAL</b> .....	<b>61-62</b>
Standard Transmission Exc. Conv. -0.15	
.....	<b>\$695.00 EA</b> ⚠
<b>2030DUAL</b> .....	<b>61-62</b>
Automatic Transmission Exc. Conv. -0.15	
.....	<b>\$695.00 EA</b> ⚠

## Dual Exhaust System - Chevy Truck

Nothing can beat the sound of the "Split Six" Dual Exhaust! This complete dual exhaust system has been designed for the do-it-yourselfer, and can be installed right in your own backyard or garage. All exhaust pipes are pre-bent, to fit and are made of aluminized tubing for long lasting life. William's Exhaust Headers will improve performance, and glass packed mufflers will give your car the sound made famous in the 50's. Complete with all necessary hardware and installation instructions, (Clamps, hangers, donuts, etc.)

Made in the USA

Note: Headers must be drilled and tapped to use heat kits 838573B or 838574B. Used to heat intake in cold climates (not required).

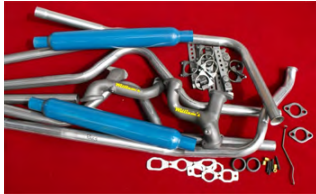

<b>2031DUAL</b> .....	<b>47-53</b>
Standard Transmission, 1/2 Ton -0.15	
.....	<b>\$695.00 EA</b> ⚠
<b>2032DUAL</b> .....	<b>54-55</b>
First Series (Standard Transmission) 1/2 Ton -0.15	
.....	<b>\$693.50 EA</b> ⚠
<b>2033DUAL</b> .....	<b>55</b>
Second Series (Standard Transmission) 1/2 Ton -0.15	
.....	<b>\$695.00 EA</b> ⚠
<b>2034DUAL</b> .....	<b>55</b>
Second Series (Automatic Transmission) 1/2 Ton -0.15	
.....	<b>\$695.00 EA</b> ⚠
<b>2035DUAL</b> .....	<b>56-57</b>
Standard Transmission, 1/2 Ton -0.15	
.....	<b>\$695.00 EA</b> ⚠
<b>2036DUAL</b> .....	<b>56-57</b>
Automatic Transmission, 1/2 Ton -0.15	
.....	<b>\$695.00 EA</b> ⚠
<b>2037DUAL</b> .....	<b>58-59</b>
Standard Transmission, 1/2 Ton -0.15	
.....	<b>\$695.00 EA</b> ⚠
<b>2038DUAL</b> .....	<b>58-59</b>
Automatic Transmission, 1/2 Ton -0.15	
.....	<b>\$695.00 EA</b> ⚠
<b>2039DUAL</b> .....	<b>60-62</b>
Standard Transmission, 1/2 Ton -0.15	
.....	<b>\$695.00 EA</b> ⚠

## Dual Exhaust System - Chevy Truck, cont.

<b>2040DUAL</b> .....	<b>60-62</b>
Automatic Transmission, 1/2 Ton -0.15	
.....	<b>\$695.00 EA</b> ⚠

## Sanderson Headers

Sanderson Headers available for many engine and Car/ Truck applications. Headers can also be custom built for any application. Please take necessary measurements and call our sales staff for pricing/applications.

**SANHEADERS** ..... **ALL**  
 Custom/ special order headers. Call our sales staff to discuss your application. Please have your measurements if possible. -0 ..... **CALL** ⚠

## Sanderson Headers - Chevy Small Block



**365798C50J** ..... **49-54**  
 Tube headers for stock steering. Ceramic coated. 3.609 -0.15 ..... **\$499.00 SET** ⚠



JET COATED SHOWN

**365798CC50** ..... **49-54**  
 Tube headers for stock steering, Chevy car. 3.609 -0.15 ..... **\$305.00 SET** ⚠



**365799CC55** ..... **55-57**  
 Plain Steel Finish - 1955-57 Chevy Applications With Small Block Chevy Straight Plug -0.15 ..... **\$305.00 EA** ⚠



**365790CC2** ..... **ALL**  
 For stock rack and pinion or cross steer. Straight or angled plug. -0.15 ..... **\$305.00 SET** ⚠

## Sanderson Headers - Chevy Small Block, cont.



**365790CC2JET** ..... **ALL**  
 For stock rack and pinion or cross steer. Straight or angled plug. Ceramic coated. -0.15 ..... **\$499.00 SET** ⚠



**365794CC1** ..... **ALL**  
 Tube 67-79 Camaro Clip, Straight Plug. 3.609 -0.15 ..... **\$285.00 SET** ⚠



PLAIN FINISH SHOWN

**365794CC1JET** ..... **ALL**  
 Tube 67-79 Camaro Clip, Straight Plug Ceramic Coated. 3.609 -0.15 ..... **\$475.00 SET** ⚠



JET COATED SHOWN

**365795AP** ..... **ALL**  
 Tube 67-79 Camaro clip, angled plugs. 3.609 -0.15 ..... **\$305.00 SET** ⚠



**365795H0** ..... **ALL**  
 Tube 67-79 Camaro Clip, High Output. 3.609 -0.15 ..... **\$390.00 SET** ⚠

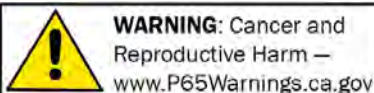

NOTE: Any chemicals will be shipped domestic ground only (Lower 48 states only). No international shipping.

**(800) 952-1752 • www.streetrodhq.com**



**Sanderson Headers - Chevy Small Block, cont.**



PLAIN FINISH SHOWN

**365795HOJET** .....ALL  
 Designed to fit 1927 and up automobiles with small block Chevrolet engines using D-Port or HO cylinder heads. This includes the GM Fastburn heads. 3.609 -0.15  
 ..... **\$580.00 SET** ⚠



**365796QPJET** .....ALL  
 Cast Iron Ceramic Coated. 3.609 -0.15  
 ..... **\$636.00 SET** ⚠



JET COATED SHOWN

**365797CC3** .....ALL  
 Tube 70-92 Camaro clip straight or angled plugs. -0.15  
 ..... **\$299.00 SET** ⚠



**365797CC3JET** .....ALL  
 Tube 70-92 Camaro clip straight or angled plugs. Ceramic coated. 3.609 -0.15  
 ..... **\$497.00 SET** ⚠

**Sanderson Headers - Chevy Big Block**



JET COATED SHOWN

**365783BB1** .....ALL  
 Tube headers for rack and pinion or cross steer. -0.15  
 ..... **\$415.00 SET** ⚠

**Sanderson Headers - Chevy Big Block, cont.**



JET COATED SHOWN

**365783BB1JET** .....ALL  
 Tube headers for rack and pinion or cross steer steering. Ceramic coated. -0.15  
 ..... **\$615.00 SET** ⚠



**365787QP** .....ALL  
 Cast Big Block. -0.15  
 ..... **\$590.00 SET** ⚠



**365787QPJET** .....ALL  
 Cast, ceramic coated -0  
 ..... **\$770.00 SET** ⚠

**Tube Headers - Chevy V8**



**R9963** .....ALL  
 Black 1942-up SB Chevy "Heavy Duty" street header (includes gaskets & hardware). -0.15  
 ..... **\$155.09 SET** ⚠

**Tube Headers - Chevy LS**

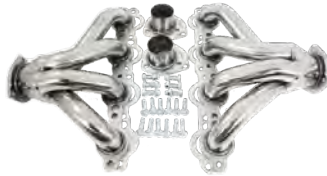

**S9935S** .....ALL  
 LS Series Block Hugger Exhaust headers. Polished Stainless Steel -0.15  
 ..... **\$150.00 SET** ⚠

**Tube Headers - Chevy LS, cont.**



**S9936S** .....ALL  
 LS Series Long Tube Headers. Polished Stainless Steel 16GA 1-1/2" Tubing 2-1/2" Collector -0.15  
 ..... **\$150.00 SET** ⚠

**Fenton Headers - Chevy Straight 6**



**3657963A** .....37-62  
 Fenton headers. Cast iron, for all 1937-62 216ci, 235ci & 261ci engines. Comes with header flange and gaskets.  
 3.609 -0.2 ..... **\$199.00 PR** ⚠

**3657963G** .....37-62  
 Fenton headers. Cast iron, for all GMC 228ci, 248ci, 270ci & 302ci engines. Comes with header flange and gaskets.  
 3.609 -0 ..... **\$199.95 PR** ⚠



**3657963S** .....37-62  
 Bolt set for Fenton headers. 3.609 -0.4  
 ..... **\$5.50 SET** ⚠



**3692831** .....ALL  
 Header pipe to Fenton or tube headers (requires 2). 3.611 -0.15  
 ..... **\$3.25 EA** ⚠

**Tube Headers - Chevy Straight 6**

A Street Rod Headquarters exclusive! Header tubing is mandrel bent providing the highest flow possible and fixture welded to ensure precise fit. Mounting flanges are O-ringed to reduce leakage. Fits Chevy 216ci, 235ci & 261ci six cylinder engines.



**3657963SS** .....37-62  
Polished stainless finish. 3.609 -0.2  
..... **\$175.00 SET** ⚠



**3657963T** .....37-62  
Black painted finish. 3.609 -0.2  
..... **\$125.00 SET** ⚠



**3692831** .....ALL  
Header pipe to Fenton or tube headers (requires 2). 3.611 -0.15 . **\$3.25 EA** ⚠

**Heat Kit**



**838574B** .....37-53  
Heat kit. Split headers to intake. 216ci only. 3.640 -0.3 ..... **\$44.25 EA** ⚠



**838573B** .....50-62  
Heat kit. Split headers to intake. 235ci only. 3.640 -0.3 ..... **\$44.25 EA** ⚠

**Headers - Ram Horn - Ford Y Block**



**2130039** .....54-64  
Ford Y-Block Tru-Ram Manifolds, Gaskets Included. -0.15 ..... **\$470.00 PR** ⚠

**Exhaust Manifold Cover**

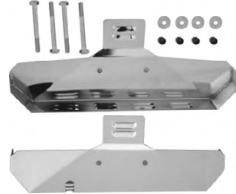

**R9066** .....ALL  
Chrome SB Chevy Exhaust Manifold Cover. -0.15 ..... **\$65.00 PR** ⚠

**Exhaust Header Bracket**



**R9008** .....ALL  
Chrome alternator bracket for Pre-1969 SB Chevy 283-350 SWP Header Bracket. -0.15 ..... **\$8.59 EA** ⚠



**R9254** .....ALL  
Chrome alternator bracket for pre-1969 SB Chevy 283-350. Driver's side. -0.15 ..... **\$8.39 EA** ⚠

**Exhaust Extension**



**51A18529A** . . .ALL  
Ford Script, Polished Stainless. -0.15  
..... **\$17.99 EA** ⚠



**51A18529B** . . .ALL  
"V-8" script, Polished Stainless. -0.15  
..... **\$17.99 EA** ⚠



**51A18529P** . . .ALL  
Plain, Polished Stainless. -0.15  
..... **\$15.00 EA** ⚠



**985992A** . . . . .ALL  
Era accessory stainless steel w/ stamped bowtie. 3.705 -0.15  
..... **\$18.50 EA** ⚠



**985992C** . . . . .ALL  
CHROME Bowtie shaped outlet. 2-1/4" I.D. (not pre-drilled). 3.705 -0.15  
..... **\$31.00 EA** ⚠



**986885S** . . . . .ALL  
STAINLESS STEEL Bowtie shape. 2-1/4" I.D. (not pre-drilled). 3.705 -0.15  
..... **\$31.00 EA** ⚠

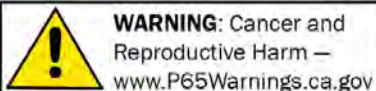

NOTE: Any chemicals will be shipped domestic ground only (Lower 48 states only). No international shipping.

**Kickdown Kits**



**KD-2350HT**.....ALL  
TH-350 Hi-Tech stainless kick down kit.  
3.700 -0 ..... \$79.00 EA ⚠



**KD-2350TP**.....ALL  
TH-350 Tune-Port stainless kick down kit.  
3.700 -0.15 ..... \$90.00 EA ⚠



**KD-2350U**.....ALL  
TH-350 stainless kick down kit. Standard adjustable GM detent (black housing) w/ stainless mounting bracket mounts to the two back manifold bolts. Designed for 4 barrel-type carburetors for small block Chevys. Kit includes extender for increased ease of unique applications.  
3.700 -0.15 ..... \$57.50 EA ⚠



**KD-2400HT**.....ALL  
TH-400 electric kick down kit is cable operated. Electric switch is housed in a billet aluminum box that mounts w/ transmission pan bolts. Kit includes cut-to-fit stainless steel teflon-lined outer housing w/ aluminum fittings & stainless steel inner wire & stainless mounting bracket. This design eliminates the unsightly electrical switches on carburetor, manifold, or near gas pedal.  
3.700 -0.15 ..... \$99.00 EA ⚠

**Kickdown Kits, cont.**



**KD-2700HT**.....ALL  
700-R4 Hi-Tech stainless kick down kit.  
3.700 -0.15 ..... \$92.79 EA ⚠



**KD-2700TP**.....ALL  
700-R4 tuned port stainless kick down kit.  
3.700 -0.15 ..... \$92.79 EA ⚠

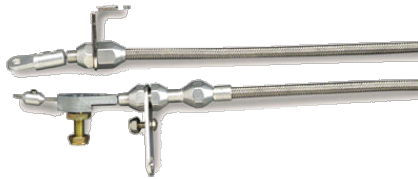

**KD-2FMXHT**.....ALL  
Ford FMX Hi-Tech stainless kick down kit.  
3.700 -0.15 ..... \$90.00 EA ⚠



**KDB-4350**.....ALL  
Kickdown stainless bracket. 3.700 -0.15 ..... \$26.75 EA ⚠



**R6051**.....ALL  
Braided stainless kick down assembly for 700-R4 carbureted. -0.15 ..... \$43.50 EA ⚠



**R6053**.....ALL  
Braided Stainless Kick Down Assembly for TH350 V8. -0.15 ..... \$35.25 EA ⚠

**Automatic Transmissions**



**A1P-T350-400HP** . ALL  
Rebuilt turbo 350 automatic transmission. 6" tailshaft. 400HP -0.15 ..... \$1,099.00 EA ⚠

**A1P-T350-600HP**.....ALL  
Rebuilt turbo 350 automatic transmission. 6" tailshaft. 600HP -0.15 ..... \$1,399.00 EA ⚠

**A1P-T350-CONV**.....ALL  
2200-2500 Stall Convertor. Turbo 350. -0.15 ..... \$295.00 EA ⚠

**Automatic Transmissions, cont.**

**A1P-T400-400HP**.....ALL  
Rebuilt turbo 400 automatic transmission. 4" tailshaft. 400HP -0.15 ..... \$1,299.00 EA ⚠

**A1P-T400-600HP**.....ALL  
Rebuilt turbo 400 automatic transmission. 4" tailshaft. 600HP -0.15 ..... \$1,499.00 EA ⚠

**A1P-T400-CONV**.....ALL  
2200-2500 Stall Convertor. Turbo 400 -0.15 ..... \$295.00 EA ⚠

**A1P-T700-400HP**.....ALL  
Rebuilt turbo 700r4 automatic transmission. 30 spline input shaft. 400HP -0.15 ..... \$1,398.59 EA ⚠

**A1P-T700-600HP**.....ALL  
Rebuilt turbo 700r4 automatic transmission. 30 spline input shaft. 600HP -0.15 ..... \$1,799.00 EA ⚠

**A1P-T700-CONV**.....ALL  
2200-2500 Stall Convertor. 700r4 -0.15 ..... \$396.19 EA ⚠

**Crossmember (Weld In) - Chevy**



**AT-1054**.....40-48  
Universal. Chevy "top hat" frames only. 4.081 -0 ..... \$118.75 SET ⚠

**Crossmember (Bolt On) - Chevy**



**ES-1123**.....37-39  
Car, Bolt-on for Turbo 400. Required for power brakes (works w/ manual brakes too). Removable. Mounting hardware included. 4.081 -0 .. \$98.25 SET ⚠

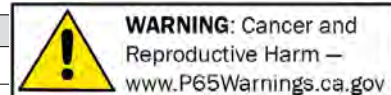

**Crossmember (Bolt On) - Chevy, cont.**



**ES-1124** ..... **37-39**  
Car, Bolt-on for Turbo 350, Powerglide or manual transmissions. Required for power brakes (works w/ manual brakes too). Removable. Mounting hardware included. 4.081-0 ..... **\$145.00 SET** ⚠



**ES-1125** ..... **37-39**  
Car, Bolt-on for 700R4. Required for power brakes (works w/ manual brakes too). Removable. Mounting hardware included. 4.081-0 ..... **\$145.00 SET** ⚠



**AT-1055** ..... **37-54**  
Universal. Chevy "top hat" frames only. 4.081-0 ..... **\$145.00 EA** ⚠



**TRANSCROSS** ..... **39-48**  
Bolt on crossmember converts your stock auto or manual trans frame to accept all GM automatic transmissions, except Powerglide. Uses all original crossmember mounting holes. Chevy car 39-48 -0.15 ..... **\$225.00 EA** ⚠

**ES-1164** ..... **40-46**  
Truck, Bolt-on to original holes for Turbo 350, Powerglide, manual trans. Also fits any trans measuring 20-5/8" from engine to trans mount holes. Required for power brakes (works w/ manual brakes too). Removable. Mounting hardware included. 4.081-0 ..... **\$98.00 SET** ⚠

**ES-1166** ..... **40-46**  
Truck, Bolt-on to original holes. Fits 700R4. 4.081-0 ..... **\$98.00 SET** ⚠

**Crossmember (Bolt On) - Chevy, cont.**



**3711049** ..... **42-57**  
Truck Universal transmission mounting bracket for engine swap. 4.081-0.15 ..... **\$62.75 EA** ⚠

**ES-1165** ..... **47-54**  
Truck, Bolt-on to original holes for Turbo 350, Powerglide, manual trans. Also fits any trans measuring 20-5/8" from engine to trans mount holes. Required for power brakes (works w/ manual brakes too). Removable. Mounting hardware included (stock steering box will need to be moved outboard slightly or changed). 4.081-0 ..... **\$90.00 SET** ⚠

**ES-1167** ..... **47-54**  
Bolt-on to original holes. Fits 700R4. 4.081-0 ..... **\$90.00 SET** ⚠

**Crossmember (Bolt On) - Ford Truck**



**ES-2051** ..... **48-52**  
Crossmember w/ master cylinder mount. Use for T-350, T-400, T-700 & C4. -0 ..... **\$165.00 EA** ⚠



**ES-2150** ..... **48-52**  
Fits most Ford & Chevy trans using firewall swing type brake pedal. Also works w/ T-400 using manual brakes w/ stock or Chassis Engineering pedal. -0 ..... **\$104.00 EA** ⚠

**Trans Mount Kit (Bolt On) - Chevy**

**ES-1170** ..... **40-48**  
Bolt-on for Turbo 350, Powerglide or manual trans. Minor modification to original crossmember. V8 applications only. Removable. Mounting hardware included. 4.081-0 ..... **\$31.00 SET** ⚠

**3703169M** ..... **49-54**  
For turbo 350. 4.081-0.3 ..... **\$62.00 EA** ⚠



**Trans Mount Kit (Weld In) -Chevy**

**ES-1190** ..... **49-52**  
For Turbo 350, Powerglide or manual trans on cars originally equipped w/ 3-speed (Exc convertible). 4.081-0 ..... **\$41.00 SET** ⚠



**ES-1192** ..... **52-54**  
For Turbo 350, Powerglide or manual trans on cars originally equipped w/ 3-speed or Powerglide (Exc convertible). 4.081-0 ..... **\$59.25 SET** ⚠

**ES-1193** ..... **52-54**  
For 700R4 trans on cars originally equipped w/ 3-speed (Exc convertible). 4.081-0 ..... **\$68.75 SET** ⚠



**Transmission Mount -Chevy**



**3711049B** ..... **42-57**  
Rubber, for turbo 350, 2-hole mount only. 4.081-0.15 ..... **\$11.00 EA** ⚠

**Trans Mount Kit -Ford Car**

**AS-2083** ..... **41-48**  
Bolt-on wishbone mounting kit. Use for C4 & manual trans. No extra side clearance needed (drop needed for clearance below). -0 ..... **\$57.00 SET** ⚠

**ES-2172** ..... **41-48**  
Type II. Use for all Turbo 350, Powerglide & manual trans w/ IFS. No provision for wishbone. -0 ..... **\$104.00 SET** ⚠



**ES-2174** ..... **41-48**  
Type II. Use for all Turbo 350, Powerglide & manual trans w/ solid axle front. Has provision for wishbone. -0 ..... **\$195.00 SET** ⚠

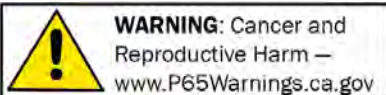

NOTE: Any chemicals will be shipped domestic ground only (Lower 48 states only). No international shipping.

**Trans Mount Kit -Ford Car, cont.**



**ES-2177** .....41-48  
Type I. Bolt-on style. Use for all Turbo 350, Powerglide & manual

cars w/ IFS (and any trans measuring 20-5/8" from engine to trans mount holes). No provision for wishbone (welding required on split wishbone models). -0

..... **\$104.00 SET** ⚠  
**ES-21770D** .....41-48

Type I. Bolt-on style. Use for all Turbo 700R4 w/ IFS (and any trans measuring 20-5/8" from engine to trans mount holes). For experienced builders only!. -0

..... **\$499.00 EA** ⚠  
**ES-2178** .....41-48

Type I. Bolt-on style. Use for all Turbo 350, Powerglide & manual cars w/ solid axle front (and any trans measuring 20-5/8" from engine to trans mount holes). With wishbone splitting kit (welding required on split wishbone models). -0

..... **\$167.00 SET** ⚠  
**ES-2272** .....41-48

Type II. Use for all Ford trans w/ IFS. No provision for wishbone. -0

..... **\$150.00 SET** ⚠



**ES-2274** .....41-48  
Type II. Use for all Ford trans w/ solid axle front. Has provision for wishbone. -0

..... **\$175.00 SET** ⚠  
**ES-2276** .....41-48

Type I. Bolt-on style. Use for all Ford trans w/ solid axle front. With wishbone splitting kit. Rubber mount included. -0

..... **\$175.00 SET** ⚠



**ES-2277** .....41-48  
Type I. Bolt-on style. Use for all Ford trans w/ IFS. No provision for wishbone. Rubber mount included. -0

..... **\$150.00 SET** ⚠

**Transmission Flywheel Dust Cover**

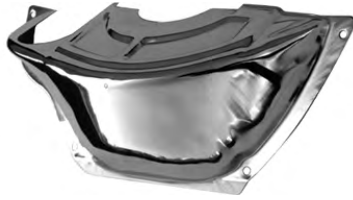

**R9417** .....ALL  
Chrome 1962-up Powerglide Flywheel Dust Cover. -0.15 ..... **\$31.89 EA** ⚠

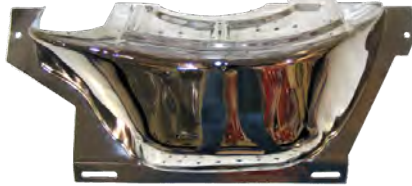

**R9587** .....ALL  
700R4, chrome. -0.15 ..... **\$36.25 EA** ⚠



**R9588** .....ALL  
Chrome, GM Turbo 350 & 400. 2-7/8" starter slot. -0.15 ..... **\$32.99 EA** ⚠

**Transmission Pan -GM**



**R7599** .....ALL  
Chrome GM Turbo 700R4 transmission pan - short & finned. -0.15 ..... **\$25.75 EA** ⚠



**R8491** .....ALL  
Polished Aluminum, GM Turbo 350 Transmission Pan. Finned (includes gasket & hardware). -0.15 ..... **\$77.69 EA** ⚠



**R8492** .....ALL  
Polished aluminum GM Turbo 400 transmission pan - finned with gasket (Includes gasket & hardware). -0.15 ..... **\$75.09 EA** ⚠

**Transmission Pan -GM, cont.**



**R9122** .....ALL  
Chrome, GM Turbo 350, Finned. -0.15 ..... **\$22.99 EA** ⚠



**R9124** .....ALL  
Chrome Chevy powerglide transmission pan - finned. -0.15 ..... **\$22.39 EA** ⚠



**R9196** .....ALL  
Chrome GM Turbo 400 transmission pan - finned & 4" deep (adds 2 1/2 qts). -0.15 ..... **\$33.00 EA** ⚠



**R9712** .....ALL  
Chrome GM Turbo 700R4 transmission pan - finned & deep style. -0.15 ..... **\$26.25 EA** ⚠

**Transmission Pan -Ford**



**R9531** .....ALL  
Chrome Ford C-4 transmission pan - finned. -0.15 ..... **\$20.00 EA** ⚠

**Trans Cooler - Single Pass**



**8514392A** .....ALL  
12" length. Aluminum. 30 deg. temp decrease to your transmission. Extra stall on converter will require 2 coolers. 1.219 -0.15 ..... **\$48.00 EA** ⚠



**8514392A20** .....ALL  
20" length. Aluminum. 30 deg. temp decrease to your transmission. Extra stall on converter will require 2 coolers. 1.219 -0.15 ..... **\$72.00 EA** ⚠



**R5050** .....ALL  
Satin aluminum transmission cooler - 12". -0.15 ..... **\$41.25 EA** ⚠

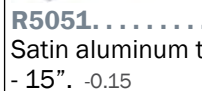

**R5051** .....ALL  
Satin aluminum transmission cooler - 15". -0.15 ..... **\$47.25 EA** ⚠

**Trans Cooler - Single Pass, cont.**

- R5052** ..... ALL  
Satin aluminum transmission cooler  
- 18". -0.15 ..... **\$62.50 EA** ⚠
- R5053** ..... ALL  
Satin aluminum transmission cooler  
- 24". -0.15 ..... **\$64.89 EA** ⚠

**Trans Cooler - Dual Pass**



-  **R5050X** ..... ALL  
Satin aluminum transmission cooler - 12". -0.15 ..... **\$46.89 EA** ⚠
- R5051X** ..... ALL  
Satin aluminum transmission cooler - 15". -0.15 ..... **\$60.00 EA** ⚠
- R5052X** ..... ALL  
Satin aluminum transmission cooler - 18". -0.15 ..... **\$55.29 EA** ⚠
- R5053X** ..... ALL  
Satin aluminum transmission cooler - 24". -0.15 ..... **\$59.49 EA** ⚠
- R5054X** ..... ALL  
Satin aluminum transmission cooler - 30". -0.15 ..... **\$61.75 EA** ⚠

**Trans Cooler Lines**

-  **GOT231101** ..... ALL  
GM Transmissions (all). -0.15 ..... **\$153.25 SET** ⚠

**Speedometer Cable Kits (Lokar)**

Premium Teflon-lined housing w/ machined aluminum fittings. Inner cable & outer housing can be cut to fit. Kit comes complete w/all fittings for GM applications. Fits TH-350, TH-400, 700-R4, Powerglide, TH-200, 200-R4 & 4L60.

-  **SP-1500U** ..... ALL  
Black housing. 4.342 -0.15 ..... **\$92.79 EA** ⚠
-  **SP-1501HT** ..... ALL  
Stainless braid housing. 4.342 -0.15 ..... **\$144.00 EA** ⚠

**Speedometer Conversion**



**CABLEX** ..... ALL  
Cable-X Mechanical Speedometer Adapter. Used to install a mechanical speedometer on a vehicle with an

electronic speedometer signal from transmission. -0

..... **\$360.00 EA** ⚠



**ERASPEEDO** ..... ALL  
Unit is used to correct speedometer reading. For transmissions with electronic speed sensor. Great for any tire/ wheel combination on street rod applications. Instructions included.

4.329 -0.15 ..... **\$145.00 EA** ⚠

**Pulse Generator**



**PULSEGENF** ..... ALL  
Ford transmissions. For electronic speedometers 9.748 -0

..... **\$75.00 EA** ⚠



**PULSEGENGM** ... ALL  
GM transmissions. For electronic speedometers 9.748 -0

..... **\$65.00 EA** ⚠

**Pulse Generator - Auto Meter**



**AUM5291** ..... ALL  
GM & most Chrysler transmissions. (for Auto Meter gauges only) -0.15

..... **\$121.50 EA** ⚠



**AUM5292** ..... ALL  
Ford transmissions (for Auto Meter gauges only) -0.15

..... **\$112.00 EA** ⚠

**Kickdown Brackets**



**R9757** ..... ALL  
Chrome GM Turbo 350 transmission kickdown bracket. -0.15

..... **\$4.00 EA** ⚠

**Transmission Dipsticks (Lokar) Chevy**

Kits come complete w/ braided stainless outer housing & heat resistant easy to read Teflon inner rod stamped with correct trans fluid levels. Comes w/ machined aluminum mount plate & fittings. Includes dipstick funnel adapter to assist with filling. Designed for "push-in" style transmissions. O-ring seals on dipstick. Available in transmount (mounts to bell housing) or firewall mount. Firewall mount measures 24" in length.



**1211144** ..... ALL  
-0 ..... **\$129.00 EA** ⚠



**TD-30PGFM** ..... ALL  
Hi-Tech for Powerglide. Mounts on firewall. 4.133 -0.15 ..... **\$102.00 EA** ⚠

**TD-3350400FM** ..... ALL  
Hi-Tech for TH-350/400. Mounts on firewall. 4.133 -0.15 ..... **\$108.50 EA** ⚠



**TD-3350TM** ..... ALL  
Hi-Tech for TH-350. Mounts on transmission. 4.133 -0.15 ..... **\$99.09 EA** ⚠

**TD-3400TM** ..... ALL  
Hi-Tech for TH-400. Mounts on transmission. 4.133 -0.15 ..... **\$96.00 EA** ⚠

**TD-3700FM** ..... ALL  
Hi-Tech for TH-700-R4. Mounts on firewall. 4.133 -0.15 ..... **\$102.00 EA** ⚠

**TD-3700TM** ..... ALL  
Hi-Tech for 700-R4. Mounts on transmission. 4.133 -0.15 ..... **\$102.00 EA** ⚠



**WARNING: Cancer and Reproductive Harm** —  
www.P65Warnings.ca.gov

NOTE: Any chemicals will be shipped domestic ground only (Lower 48 states only). No international shipping.

**Transmission Dipstick -Chevy**



**R4994**.....**ALL**  
 Chrome GM Turbo 350 transmission dipstick - 34" long. -0.15  
 ..... **\$13.00 EA** ⚠



**R4994BA**.....**ALL**  
 Billet aluminum handle GM Turbo 350 transmission dipstick - 34" long. -0.15  
 ..... **\$16.25 EA** ⚠



**R5005**.....**ALL**  
 Polished aluminum braided GM Turbo 400 transmission dipstick. -0.15  
 ..... **\$44.75 EA** ⚠



**R5006**.....**ALL**  
 Polished aluminum braided Chevy 700 R4 transmission dipstick. -0.15  
 ..... **\$36.49 EA** ⚠



**R5104**.....**ALL**  
 Polished aluminum braided GM Turbo 350/400 transmission dipstick (firewall mount). -0.15  
 ..... **\$65.50 EA** ⚠

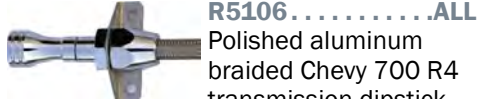

**R5106**.....**ALL**  
 Polished aluminum braided Chevy 700 R4 transmission dipstick (firewall mount). -0.15  
 ..... **\$60.25 EA** ⚠

**R9421BA**.....**ALL**  
 Billet aluminum handle GM Turbo 350 transmission dipstick and tube - 27" long. -0.15  
 ..... **\$21.50 EA** ⚠



**R9422**.....**ALL**  
 Chrome Chevy Powerglide Transmission Dipstick. -0.15  
 ..... **\$11.75 EA** ⚠

**Transmission Dipsticks (Lokar) Ford**

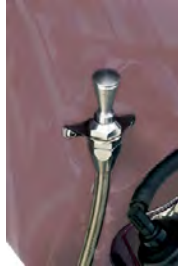

**TD-3FMXFM** ..**ALL**  
 Hi-Tech for FMX. Mounts on firewall. 4.133 -0.15  
 ..... **\$102.00 EA** ⚠



**TD-3FMXTM** ..**ALL**  
 Hi-Tech for FMX. Mounts on transmission. 4.133 -0.15  
 ..... **\$96.00 EA** ⚠

**Transmission Dipstick -Ford**



**R5101**.....**ALL**  
 Polished aluminum braided ford C6 transmission dipstick (firewall mount). -0.15  
 ..... **\$63.25 EA** ⚠

**Line Clamp - Stainless**



**13275**.....**ALL**  
 3/16" x 3/8" double combination (6 clamps). 8.950 -0.15 ..... **\$17.00 SET** ⚠  
**13276**.....**ALL**  
 3/16" x 3/16" double (6 clamps). 8.950 -0.15 ..... **\$17.00 SET** ⚠  
**13284**.....**ALL**  
 5/16" x 3/8" double combination (6 clamps). 8.950 -0.15 ..... **\$16.99 SET** ⚠

**Bump Shifters**

The Bumpshift is a stand-alone slap/bump shifter to give the driver a sequential style shifter that is surface mountable. You can mount the bump shifter virtually anywhere that has a flat surface for any automatic transmission. By pulling or pushing on the bump shift lever you give the shift commands to either up shift or downshift. You can specify whether an up shift is back or an up shift is forward on the shift lever by changing the orientation of the yellow and orange wires on the bump shifter.

The bump shifter has a very positive shift feel and utilizes contact-less switches for a robust feel and accurate shift every time. A boot is provided that covers the hardware of the bump shifter for a clean installation.

Includes electronic controllers as needed.  
**MS-BMPSHFTA** ..**ALL**  
 Automatic trans slap/ bump shifter. -0  
 ..... **\$2,449.00 KIT** ⚠



**MS-BMPSHFTM** ..**ALL**  
 Manual trans slap/ bump shifter. -0  
 ..... **\$2,649.00 KIT** ⚠

**MasterShift Paddle Shifters**

The 'Mastershift' Auto Shifter paddle kit enables you to shift your automatic or manual shift automatic transmission while leaving your hands on the steering wheel. It provides a quick and reliable electronically controlled movement of the transmission shift lever. The shifter unit is coupled to the transmission through a standard shift cable, just like the manual shift lever; this makes installation quick and easy. The 'MasterShift' Auto Shifter supports transmissions with a single, rotating transmission shift shaft that has one position for each gear. Common automatic transmissions fall in this category, as do some less common manual shift automatic transmissions.

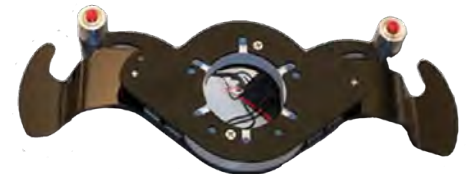

**MS-0005**.....**ALL**  
 Automatic transmissions. -0  
 ..... **\$1,950.00 KIT** ⚠

**MasterShift Paddle Shifters, cont.**



**MS-0005-U1 . . . . .ALL**  
Manual trans slap/  
bump shifter. -0  
..... **\$525.00 EA** ⚠

**Automatic Transmission Shifters (Lokar) -Chevy**

Lokar shifters are designed to help prevent accidental shifting by locking the lever in the park position with Lokar's exclusive Safety Lock-Out Button. The shifter is completely adjustable so that it can be mounted in any number of positions from front to rear with the exclusive main plate & side brackets. Mount the shifter in any existing floor opening or custom location. Also available in black anodized Midnight Series.



**ATS6350AN . . . . .ALL**  
TH-350 nostalgia  
style shifter w/ 2  
bends in 23" lever  
w/ black mushroom  
knob. 4.009 -0  
..... **\$298.50 EA** ⚠



**ATS6350ANX . . . . .ALL**  
Midnight Series.  
TH-350 nostalgia  
style shifter w/ black  
mushroom knob.  
4.009 -0  
..... **\$299.00 EA** ⚠



**ATS6350BM . . . . .ALL**  
TH-350 16" lever w/  
brushed aluminum  
mushroom knob.  
4.009 -0.15  
..... **\$324.75 EA** ⚠



**ATS6350BMX . . . . .ALL**  
Midnight Series.  
TH-350 16"  
lever w/ brushed  
aluminum, Black  
anodized mushroom  
knob. 4.009 -0.15  
..... **\$324.69 EA** ⚠

**Automatic Transmission Shifters (Lokar) -Chevy, cont.**



**ATS6400BM . . . . .ALL**  
TH-400 16" lever w/  
brushed aluminum  
mushroom knob.  
4.009 -0.15  
..... **\$324.69 EA** ⚠



**ATS6400BMX . . . . .ALL**  
Midnight Series.  
TH-400 16" lever w/  
brushed aluminum,  
Black anodized  
mushroom knob.  
4.009 -0.15  
..... **\$301.00 EA** ⚠



**ATS6700CM . . . . .ALL**  
TH-700-R4 12"  
lever w/ brushed  
aluminum  
mushroom knob.  
4.009 -0.15  
..... **\$293.00 EA** ⚠



**ATS6700CMX . . . . .ALL**  
Midnight Series.  
TH-700-R4 12"  
Black lever w/ black  
brushed aluminum  
mushroom knob.  
4.009 -0.15  
..... **\$293.00 EA** ⚠

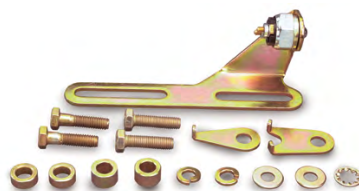

**BL-1400U . . . . .ALL**  
Choice of back-up light switch or neutral  
safety switch kit. Kit fits TH-350, TH-400,  
TH-200, 700-R4, 200-R4, 4L60, 4L60E &  
4L80E transmissions w/ column or floor  
shift. Single trigger for back-up light  
switch, or double trigger for neutral safety  
switch. Kit not intended to function as  
both. All mounting hardware included.  
2.459 -0.15 ..... **\$38.50 EA** ⚠

**Automatic Transmission Shifters (Lokar) -Chevy, cont.**



**COS6700CM . . . . .ALL**  
TH-700-R4 12"  
lever w/ brushed  
aluminum  
mushroom knob.  
4.009 -0.15  
..... **\$354.00 EA** ⚠



**FMS6700BM . . . . .ALL**  
Floor mounted  
shifter comes w/  
exclusive floor  
mount brackets that  
allow for installation  
above or below  
the floor on the  
transmission tunnel.  
Kit includes quad

arm & quad arm offsets for mounting to  
right or left. Removal of the transmission  
is not necessary. Fits 700-R4. 16" length.  
4.009 -0.15

..... **\$297.50 EA** ⚠



**FMS6700BMX . . . . .ALL**  
Midnight series.  
Floor mounted  
shifter. Black  
anodized. 4.009 -0.15

..... **\$284.00 EA** ⚠

**Column Shift Linkage**



**13272 . . . . .ALL**  
Connection kit (short). Fits TH200, TH350,  
TH400, TH700R, 4L60, 4L60E & 4L80E.  
4.019 -0.15 ..... **\$60.00 EA** ⚠



**13273 . . . . .ALL**  
Connection kit (long). Fits TH200, TH350,  
TH400, TH700R, 4L60, 4L60E & 4L80E.  
4.019 -0.15 ..... **\$68.89 EA** ⚠

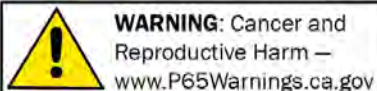

NOTE: Any chemicals will be shipped domestic ground only (Lower 48 states only). No international shipping.



**Column Shift Linkage, cont.**



**ACA-1800.....ALL**  
Column shift linkage. Simplify connecting your column shift to your transmission with a machined billet aluminum adjustable column shift linkage kit. Fits TH-350, TH-400, TH-200, 700-R4, 200-R4, 4L60, 4L60E & 4L80E. 4.032 -0.15  
..... **\$74.50 SET** ⚠



**ACA-1801.....ALL**  
Column shift linkage. Simplify connecting your column shift to your transmission w/ machined billet aluminum adjustable column shift linkage kit. Fits C-4/C-6 4.032 -0.15  
..... **\$70.00 SET** ⚠



**ACA-1804.....ALL**  
Column cable shift linkage. Simplify connecting your column shifter to your transmission with an adjustable cable column shift linkage kit. For 2" columns. Fits TH-350, TH-400, TH-200, 700-R4, 200-R4, 4L60, 4L60E & 4L80E. 4.032 -0.15  
..... **\$161.50 SET** ⚠



**ACA-1805.....ALL**  
Column cable shift linkage. Simplify connecting your column shifter to your transmission with an adjustable cable column shift linkage kit. For 2-1/4" columns. Fits TH-350, TH-400, TH-200, 700-R4, 200-R4, 4L60, 4L60E & 4L80E. 4.032 -0.15  
..... **\$157.00 SET** ⚠



**ACA-1807.....ALL**  
Column shift linkage. Simplify connecting your column shift to your transmission w/ machined billet aluminum adjustable column shift linkage kit. Fits Ford AOD 4.032 -0.15  
..... **\$68.89 SET** ⚠

**Column Shift Linkage, cont.**

**ACA-1808.....ALL**  
Column shift linkage. Simplify connecting your column shift to your transmission w/ machined billet aluminum adjustable column shift linkage kit. Fits Ford 4R70W/AODE 4.032 -0.15  
..... **\$67.00 SET** ⚠

**Shift Boot - LED (Lokar)**



**CINB-1748.....ALL**  
LED indicator with boot. Round, Vertical for TH350/ 400. Comes with billet boot clamp, control module, boot and indicator. -0.15  
..... **\$267.00 KIT** ⚠



**CINB-1749.....ALL**  
LED indicator with boot. Round, Horizontal for 700R4 & 4L60. Comes with billet boot clamp, control module, boot and indicator. Brushed finish. -0.15  
..... **\$250.00 KIT** ⚠



**CINB-1749X.....ALL**  
LED indicator with boot. Round, Horizontal for 700R4 & 4L60. Comes with billet boot clamp, control module, boot and indicator. Black (Midnight Series) brushed finish. -0.15  
..... **\$280.00 KIT** ⚠



**CINB-1780.....ALL**  
LED indicator with boot. Rectangular, Vertical for TH350/400. Comes with billet boot clamp, control module, boot and indicator. Brushed finish. -0.15  
..... **\$278.00 KIT** ⚠

**Shift Boot - LED (Lokar), cont.**



**CINB-1780X.....ALL**  
LED indicator with boot. Rectangular, Vertical for TH350/400. Comes with billet boot clamp, control module, boot and indicator. Black (Midnight Series) brushed finish. -0.15  
..... **\$292.00 KIT** ⚠

**Shift Boot (Lokar)**



**70-BHRB.....ALL**  
Hot rod shifter boot comes with brushed finish billet aluminum ring w/ ball-milled edge. Trim ring 5-1/4" od. 4.612 -0.15  
..... **\$66.25 EA** ⚠

**70-BHRBX.....ALL**  
Midnight Series. Hot rod shifter boot comes with brushed finish billet aluminum ring w/ ball-milled edge. Trim ring 5-1/4" o.d. Round, black anodized. 4.612 -0.15  
..... **\$66.79 EA** ⚠



**70-CLB.....ALL**  
Classic shifter boot. Polished stainless trim ring 5" o.d. 4.612 -0.15  
..... **\$44.50 EA** ⚠



**70-FMB.....ALL**  
Rectangular polished stainless floor mount shifter boot. 5-1/4" x 6-3/4". 4.612 -0.15  
..... **\$42.25 EA** ⚠



**70-HRB.....ALL**  
Hot rod shifter boot. Polished stainless trim ring 5" o.d. 4.612 -0.15  
..... **\$32.50 EA** ⚠

**Shift Boot**



**R9630.....ALL**  
Small Shifter Boot - 5 5/8" x 6 3/4". -0.15  
..... **\$10.00 EA** ⚠

**Shift Boot, cont.**

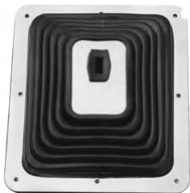

**R9631.....ALL**  
 Large Shifter Boot - 7  
 3/4" x 8 3/4". -0.15  
 ..... **\$19.19 EA** ⚠️

**Shift Boot Ring - Billet Specialties**



**BIS279310.....ALL**  
 Polished Ring only. No  
 boot. Neo-mechanical  
 design sets this interior  
 finishing piece apart  
 from the pack. OD  
 5.75" x 7.125" ID 4.125" x 5.5" 4.612-0

..... **\$60.49 EA** ⚠️



**BIS279310BLK...ALL**  
 Black ring only, no  
 boot. Neo-mechanical  
 design sets this interior  
 finishing piece apart  
 from the pack.

OD 5.75" x 7.125" ID 4.125" x 5.5"  
 4.612-0.15

..... **\$65.00 EA** ⚠️

**Gear Shift Indicator Sending Unit**



**GSS-2000.....ALL**  
 Use w/ Dakota digital gear shift position  
 indicators & 12v LED indicators. Universal  
 mounting hardware fits all automatic  
 transmissions. Fully push button  
 adjustable w/ no magnets to align. Built in  
 Neutral safety switch and back-up light  
 circuit. Can be mounted inside vehicle for  
 easy access. -0.15 ..... **\$99.75 EA** ⚠️

**Gear Position Indicator - LED**

12VDC LED Gear Position Indicator for surface  
 mount applications. Plate is held on by first  
 drilling the holes for the LED through the dash  
 and running wire from LED's into the dash.  
 When the plate is placed against the dash it  
 will be held in place by the LED's.

Gear indicator plate measures 1" x 3" x 1/16"  
 thick. Acrylic material with textured silver face  
 replicates brushed aluminum appearance for a  
 budget-friendly alternative.



**DGS-12.....ALL**  
 Horizontal. 4.038 -0.15 ..... **\$24.99 EA** ⚠️

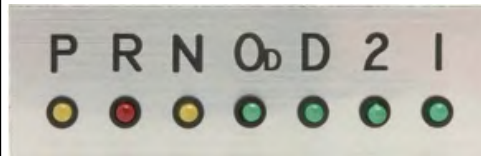

**DGS-13.....ALL**  
 Horizontal for Overdrive. 4.038 -0.15  
 ..... **\$25.00 EA** ⚠️

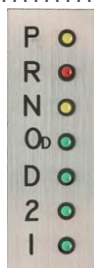

**DGS-13V.....ALL**  
 Vertical for  
 Overdrive. 4.038 -0.15  
 ..... **\$25.00 EA** ⚠️

**Billet Shift Knobs**

These cool billet shift knobs come in a variety  
 of designs. Universal fitment.



**R9312.....ALL**  
 Chrome. Piston  
 Style. -0.15  
 ..... **\$8.00 EA** ⚠️



**SHIFT-BD-1371 .ALL**  
 Brushed finish,  
 universal fit. -0  
 ..... **\$25.00 EA** ⚠️

**Billet Shift Knobs, cont.**



**SHIFT-BD-1513 .ALL**  
 #1513.  
 Brushed finish,  
 universal fit. -0.15  
 ..... **\$25.00 EA** ⚠️

**Shift Knob**



**R9313.....ALL**  
 Chrome Skull Shifter  
 Knob -0.15  
 ..... **\$10.25 EA** ⚠️



**SHIFT70605.....ALL**  
 Chrome Dice Shift Knob 50mm -0.15  
 ..... **\$13.00 EA** ⚠️

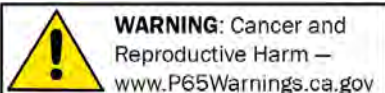

**WARNING: Cancer and  
 Reproductive Harm —**  
[www.P65Warnings.ca.gov](http://www.P65Warnings.ca.gov)

NOTE: Any chemicals will be shipped domestic ground only (Lower 48 states only). No international shipping.

**Ring & Pinion Conversion Kit - Chevy**



**3705430A** .....40-54  
Chevy Car 3.55:1 (bolt in 40-50, 1937-39 requires drive line modification). 5.529 -0.2  
..... **\$370.00 SET** ⚠

**3705439A** ..... 40-54  
3.55:1 Chevy trucks 1/2 ton only! Bolt in for 1940-53 (1937-39 requires drive line modifications). 1954 1/2 Ton truck needs the correct carrier to install this conversion (spool casting #3652336-40-43, 1/2 Ton trucks).  
Will not fit Canadian spec trucks.  
5.529 -0.15 ..... **\$370.00 SET** ⚠

**Ring & Pinion Conversion Kit - Ford**

**B8AZ209350** ... 57-72  
Ring & pinion set, Ford 9" rear end - 3.50 ratio. -0.15  
..... **\$160.00 EA** ⚠

**B8AZ4209370** .. 57-72  
Ring & pinion set, Ford 9" rear end - 3.70 ratio. -0.15  
..... **\$160.00 EA** ⚠

**B8AZ209389** .. 57-72  
Ring & pinion set, Ford 9" rear end - 3.89 ratio. -0.15  
..... **\$165.00 EA** ⚠

**B8AZ4209411** .. 57-72  
Ring & pinion set, Ford 9" rear end - 4.11 ratio. -0.15  
..... **\$155.00 EA** ⚠

**Ring & Pinion Installation Kit - Chevy**

**3705430K** ..... 40-50  
Chevy car. Gaskets, Seals, Bearings & Shim Kits needed to install Ring & Pinion. 5.529 -0.15 ..... **\$499.00 SET** ⚠

**3705430KT** ..... 40-50  
Chevy truck gaskets, seals, bearings. 5.529 -0.15 ..... **\$499.00 SET** ⚠

**3705439K** .....51-54  
Chevy car. gaskets, seals, bearings 5.529 -0.15  
..... **\$499.00 EA** ⚠

**Ring & Pinion Installation Kit - Chevy, cont.**



**3705439KT** .....51-54  
Chevy. Gaskets, Seals, Bearings. 5.529 -0.15  
..... **\$499.00 EA** ⚠

**Ring & Pinion Installation Kit - Ford**

**5590919** .....ALL  
Ford 9" Overhaul Kit (without carrier bearings) -0.15  
..... **\$74.75 KIT** ⚠

**5590920** .....ALL  
Ford 9" Overhaul Kit (With Carrier Bearings) -0.15  
..... **\$110.00 EA** ⚠

**Differential Covers - GM**

**R4786** .....ALL  
Chrome Chevy/GMC intermediate differential cover w/o plug - 10 bolt (Includes gasket & hardware). -0.15  
..... **\$25.00 EA** ⚠

**R5073** .....ALL  
Polished aluminum GM differential cover - 12 bolt w/ 8.75" ring gear. (Includes gasket & hardware). -0.15  
..... **\$99.00 EA** ⚠

**R5075** .....ALL  
Polished aluminum GM differential cover - 14 Bolt w/ 10.5" ring and pinion. (Includes gasket & hardware). -0.15  
..... **\$100.25 EA** ⚠

**R9069** .....ALL  
Chrome Chevy/GMC truck differential cover - 10 bolt front (Includes gasket & hardware). -0.15  
..... **\$26.50 EA** ⚠

**R9070** .....ALL  
Chrome Chevy/GMC truck differential cover - 12 bolt rear (Includes gasket & hardware). -0.15  
..... **\$25.49 EA** ⚠

**Differential Covers - GM, cont.**

**R9071** .....ALL  
Chrome Chevy/GMC truck differential cover - 14 bolt rear (Includes gasket & hardware). -0.15  
..... **\$28.00 EA** ⚠

**R9190** .....ALL  
Chrome GM differential cover - 10 bolt (Includes gasket & hardware). -0.15  
..... **\$22.25 EA** ⚠

**R9583** .....ALL  
Chrome GM differential cover with plug - 10 bolt (Includes gasket & hardware). -0.15  
..... **\$26.09 EA** ⚠

**Differential Covers - Ford**

**R5079** .....ALL  
Polished aluminum Ford differential cover - 12 bolt (truck/van) Includes gasket & hardware. -0.15  
..... **\$105.50 EA** ⚠

**R9465** .....ALL  
Chrome Ford differential cover - 10 bolt w/ 8.8" ring gear (Includes gasket & hardware). -0.15  
..... **\$27.00 EA** ⚠

**R9467** .....ALL  
Chrome Ford differential cover - 12 bolt w/ 9.5" ring gear (Includes gasket & hardware). -0.15  
..... **\$32.75 EA** ⚠

**Differential Covers - Mopar**

**R4816** .....ALL  
Chrome Dana 60 differential cover - 10 bolt (Includes gasket & hardware). -0.15  
..... **\$27.00 EA** ⚠

**R5070** .....ALL  
Polished aluminum Dana 25-27-30 differential cover - 10 bolt (Includes gasket & hardware). -0  
..... **\$82.00 EA** ⚠

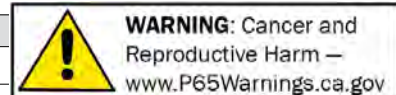

**Differential Covers - Mopar, cont.**



**R5076** .....ALL  
 Polished aluminum  
 Dana 60 differential  
 cover - 10 bolt (Includes  
 gasket & hardware). -0

..... **\$82.00 EA** ⚠



**R5080** .....ALL  
 Polished aluminum  
 Dana 80 differential  
 cover - 10 bolt w/  
 13" ring and pinion  
 (Includes gasket &  
 hardware). -0

..... **\$102.00 EA** ⚠



**R9238** .....ALL  
 Chrome Dana 30  
 differential cover - 10  
 bolt (Includes gasket &  
 hardware). -0.15

..... **\$27.50 EA** ⚠



**R9710** .....ALL  
 Chrome Dana 30 thick  
 differential cover - 10  
 bolt (Includes gasket &  
 hardware). -0.15

..... **\$28.00 EA** ⚠

170



**WARNING:** Cancer and  
 Reproductive Harm –  
[www.P65Warnings.ca.gov](http://www.P65Warnings.ca.gov)

NOTE: Any chemicals will be shipped domestic ground only (Lower 48 states only). No international shipping.

**Pedal Mount -Chevy**



**AS-1048PT . . . . .47-54**  
Easily update your truck's brake system with this kit. Fits both standard and power brakes for master cylinders. Bolt-on

Installation Instructions for AS-1048PT Bolt on brake pedal bracket and master cylinder mount for 1948-1954 Chevy Pickup Truck For power or manual brake application. 4.648 -0 .. **\$173.00 EA** ⚠

**Wilwood Disc Brake Kits - Chevy**

Looking for a different application? Please call for availability.



**14011811 . . . . .49-62**  
Forged Dynalite Pro Series Front Brake Kit 11" Rotor Black Caliper 49-54 Chevy Car / 53-62 Corvette -0  
..... **\$799.00 EA** ⚠



**14011811R . . . . .49-62**  
Forged Dynalite Pro Series Front Brake Kit 11" Rotor Red Caliper 49-54 Chevy Car / 53-62 Corvette -0  
..... **\$799.00 EA** ⚠



**14011812 . . . . .49-62**  
Forged Dynalite Pro Series Front Brake Kit 12.19" Rotor Black Caliper 49-54 Chevy Car / 53-62 Corvette -0  
..... **\$737.50 EA** ⚠



**14011812R . . . . .49-62**  
Forged Dynalite Pro Series Front Brake Kit 12.19" Rotor Red Caliper 49-54 Chevy Car / 53-62 Corvette -0  
..... **\$827.50 EA** ⚠



**14010737 . . . . .55-57**  
Forged Dynalite Pro Series Front Brake Kit 12.19" Rotor Black Caliper 55-57 Chevy Car -0  
..... **\$1,125.00 EA** ⚠



**14010737R . . . . .55-57**  
Forged Dynalite Pro Series Front Brake Kit 12.19" Rotor Red Caliper 55-57 Chevy Car -0  
..... **\$1,125.00 EA** ⚠

**Wilwood Disc Brake Kits - Chevy, cont.**



**14011491 . . . . .55-57**  
Forged Dynalite Pro Series Front Brake Kit 11" Rotor Black Caliper 55-57 Chevy Car -0  
..... **\$712.50 EA** ⚠



**14011491R . . . . .55-57**  
Forged Dynalite Pro Series Front Brake Kit 11" Rotor Red Caliper 55-57 Chevy Car -0  
..... **\$802.50 EA** ⚠

**Wilwood Disc Brake Kits - Ford**



**14011013 . . . . .37-48**  
Forged Dynalite Pro Series Front Brake Kit 11" Rotor Black Caliper 37-48 Ford Passenger Car Spindle -0  
..... **\$687.50 EA** ⚠



**14011013P . . . . .37-48**  
Forged Dynalite Pro Series Front Brake Kit 11" Rotor Polished Caliper 37-48 Ford Passenger Car Spindle -0  
..... **\$780.00 EA** ⚠



**1408583 . . . . .37-48**  
Forged Dynalite Pro Series Front Brake Kit 12.19" Rotor Black Caliper 37-48 Ford Passenger Car Spindle -0  
..... **\$737.50 EA** ⚠



**1408583R . . . . .37-48**  
Forged Dynalite Pro Series Front Brake Kit 12.19" Rotor Red Caliper 37-48 Ford Passenger Car Spindle -0  
..... **\$827.50 EA** ⚠

**Front Disc Brake Conversion Kit -Chevy**

These early Chevrolet disc brake conversion kits are engineered and designed to bolt on to your stock Chevrolet spindle. Absolutely no machine work is required! Installation is accomplished using simple hand tools and the components supplied in the kit.

Basic kit includes; New rotors, rebuilt calipers, semi-metallic pads, mounting bolts, new inner & outer bearings & seals, caliper mounting brackets, attaching hardware, bearing adapters (where required) and complete instructions.

(brake hoses sold separately. Use EC-751)  
**EC-6711SCK . . . . .28-40**  
Car & 1/2 ton truck. Complete kit for straight axles. Including rotors, calipers, pads, brackets & fasteners (brake hoses sold separately). 6x5.5" lug. Does not include bearings or seals. Uses original bearings and seals for 29-40. Inner Bearing 909002 26-40, Outer Bearing 909001 29-57, Seal 352488 29-40. -0  
..... **\$476.25 KIT** ⚠



**EC-711SCK . . . . .28-40**  
Car & 1/2 ton truck. Complete kit for straight axles. Including rotors, calipers, pads, brackets & fasteners (brake hoses sold separately). 5x4-3/4" lug. (exc. 33-36 standard cars and trucks w/ light duty spindle). -0  
..... **\$475.25 KIT** ⚠

**EC-707CK . . . . .39-40**  
Car. Complete kit for knee action. Including rotors, calipers, pads, brackets & fasteners (brake hoses sold separately). 5 lug standard. -0  
..... **\$460.75 KIT** ⚠

**EC-706CK . . . . .41-48**  
Car. Complete kit including rotors, calipers, pads, brackets & fasteners (brake hoses sold separately). 5 lug standard. -0  
..... **\$476.25 KIT** ⚠

**EC-6711CK . . . . .41-54**  
1/2 ton truck. Complete kit for straight axles. Including rotors, calipers, pads, brackets & fasteners (brake hoses sold separately). 6x5.5" lug NO HUB, NO SEALS, NO BEARINGS -0  
..... **\$476.25 KIT** ⚠

**EC-711CK . . . . .41-54**  
For 1/2 Ton Truck. Complete kit including rotors, calipers, pads, brackets & fasteners (brake hoses sold separately). 5 lug standard. -0  
..... **\$476.25 KIT** ⚠

Returns require a return authorization number—Please call first. · Note: Product pricing and availability subject to change.



**Front Disc Brake Conversion Kit -Chevy, cont.**

- EC-702CK**..... 49-54  
Car. Complete kit including rotors, calipers, pads, brackets & fasteners (brake hoses sold separately). 5 lug standard. -0 ..... **\$457.25 KIT** ⚠
- EC-708ACK**..... 55-58  
Chevy passenger cars with stock spindles. Front disc brake complete kit -0 ..... **\$700.00 EA** ⚠
- EC-712CK**.....59-64  
Chevy Passenger Car Front Disc Brake Complete Kit -0 ..... **\$480.00 EA** ⚠

**Disc Brake Conversion Bracket Kit -Chevy**



- EC-711S** .....28-40  
Car & 1/2 ton truck. Bracket kit only (no rotors, calipers, pads, etc). (exc. 33-36 standard cars and trucks w/ light duty spindle). -0.15 ..... **\$197.50 KIT** ⚠
- EC-707** ..... 39-40  
Car, Bracket kit only (no rotors, calipers, pads, etc). -0.15 ..... **\$205.00 KIT** ⚠
- EC-706** ..... 41-48  
Car, Bracket kit only (no rotors, calipers, pads, etc). -0.15 ..... **\$204.50 KIT** ⚠
- EC-711** ..... 41-54  
1/2 ton truck, Bracket kit only (no rotors, calipers, pads, etc). 1/2 ton only. -0.15 ..... **\$205.00 KIT** ⚠
- EC-702** ..... 49-54  
Car, Bracket kit only (no rotors, calipers, pads, etc). -0.15 ..... **\$191.75 KIT** ⚠
- EC-708** .....55-58  
Chevy passenger cars with stock spindles. Front disc brake basic kit -0 ..... **\$185.00 EA** ⚠
- EC-712** .....59-64  
Chevy passenger car front disc brake basic kit -0 ..... **\$175.00 EA** ⚠

**Disc Brake Conversion Kit - Dodge/ Plymouth - Front**

- EC-757CK**.....37-41  
Dodge and Plymouth passenger car and 37-52 Pickup front disc brake conversion complete kit . -0 ..... **\$750.25 EA** ⚠

**Disc Brake Conversion Kit - Dodge/ Plymouth - Front**

- EC-758CK**.....46-54  
Dodge and Plymouth passenger car (Plymouth passenger car with 10" drums), front disc brake conversion complete kit. -0 ..... **\$750.25 EA** ⚠
- EC-759CK**.....55-56  
55-56 Dodge and Plymouth passenger cars with 11" drums, front disc brake conversion complete kit. -0 ..... **\$750.00 EA** ⚠
- EC-766CK**.....57-61  
1957-61 Dodge and Plymouth passenger car, 1958-1961 Chrysler front disc brake conversion complete kit. -0 ..... **\$750.00 EA** ⚠

**Disc Brake Conversion Kit - Ford - Front**

- EC-709CK**.....37-48  
1937-48 Ford passenger car & 1937-47 pickup front disc brake conversion complete kit. 4-1/2" bolt circle. -0 ..... **\$475.00 EA** ⚠
- EC-710CK**.....48-56  
Ford pickup front disc brake conversion complete kit. 4-1/2" bolt circle -0 ..... **\$475.00 EA** ⚠
- EC-721FCK**..... 49-53  
49-53 Ford passenger car & 1952-53 Mercury front disc brake conversion complete kit. 4-1/2" bolt circle. -0 ..... **\$450.00 EA** ⚠
- EC-734CK**.....57-64  
Ford car front disc brake conversion complete kit. 4-1/2 bolt circle. -0 ..... **\$750.00 EA** ⚠

**Disc Brake Conversion Bracket Kit - Ford**

- EC-709** .....37-48  
1937-48 Ford passenger car & 1937-47 pickup disc brake conversion basic kit. 4-1/2" bolt circle -0 ..... **\$180.00 EA** ⚠
- EC-710** .....48-56  
Ford pickup front disc brake conversion basic kit. 4-1/2" bolt circle. -0 ..... **\$180.00 EA** ⚠
- EC-721F** ..... 49-53  
1949-53 Ford Pass. Car & 1952-53 Mercury disc brake conversion basic kit. 4-1/2" bolt circle -0 ..... **\$200.00 EA** ⚠
- EC-734** .....57-64  
Ford car front disc brake conversion basic kit. 4-1/2 bolt circle. -0.15 ..... **\$300.00 EA** ⚠

**Rear Disc Brake Conversion Kit**

Rear disc brake conversion kit adapts Cadillac Seville/ Eldorado rear calipers and 11 inch rear rotors. Calipers utilize the OEM integral parking brake mechanism and standard GM pads. These conversions are the easiest way to upgrade to rear disc brakes with a functional OEM style parking brake. Kits are supplied with rebuilt rear caliper assemblies with pads, new 11" rotors, caliper brackets and mounting hardware. Axle bearing removal is NOT required for installation.  
NOTE: Minor axle flange machining is required for rotor installation on some Ford and GM installations.



- EC-840** .....ALL  
Ford 8" & 9" rear ends, 4-1/2" bolt circle (small housing & flange). -0 ..... **\$600.00 KIT** ⚠
- EC-841** ..... ALL  
Ford 8" & 9" rear ends, 4-1/2" bolt circle (large housing & flange). -0 ..... **\$600.00 KIT** ⚠
- EC-842** ..... ALL  
Ford 8" & 9" rear ends, 4-1/2" bolt circle (new style flange). -0 .. **\$675.00 KIT** ⚠
- EC-844** ..... ALL  
Chevy 10 or 12 bolt rear end with axle retainers (non "C" clip), 4-3/4" bolt circle (new style flange). -0 .. **\$675.00 KIT** ⚠
- EC-845** ..... ALL  
Chevy 10 or 12 bolt rear end with axle retainers ("C" clip only), 4-3/4" bolt circle. -0 ..... **\$676.50 KIT** ⚠
- EC-846** ..... ALL  
55-64 Chevy rear ends, 4-3/4" bolt circle. -0 ..... **\$675.00 KIT** ⚠

**Master Cylinder Adapter Kit -Chevy**

Adapts master cylinder to your vehicle. Uses stock Chevy brake and clutch pedal (if desired) and pedal pivot shaft. Comes complete with hardware, pushrod, and master cylinder boot.  
**EC-430** .....37-39  
Adapts Mustang master cylinder (our part EC-445) to 37-39 Chevrolet passenger cars . Uses stock Chevy brake and clutch pedal (if desired) and pedal pivot shaft. Comes complete with hardware, pushrod, and master cylinder boot. -0 ..... **\$150.00 KIT** ⚠

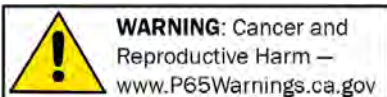

NOTE: Any chemicals will be shipped domestic ground only (Lower 48 states only). No international shipping.

**Master Cylinder Adapter Kit -Chevy, cont.**

**EC-440** ..... 40-54  
Adapts Mustang master cylinder (our part EC-445) to 40-54 Chevrolet passenger cars (exc. Cabriolet/ Convertible). Uses stock Chevy brake and clutch pedal (if desired) and pedal pivot shaft. Comes complete with hardware, pushrod, and master cylinder boot. Automatic transmissions only. -0 **\$150.00 KIT** ⚠



**EC-440S** ..... 40-54  
Adapts Mustang master cylinder (our part EC-445) to 40-54 Chevrolet passenger car (exc. Cabriolet/ Convertible) . Uses stock Chevy brake and clutch pedal (if desired) and pedal pivot shaft. Comes complete with hardware, pushrod, and master cylinder boot. Manual transmissions only. -0.15 **\$198.75 KIT** ⚠

**EC-420** ..... 47-54  
Adapts either EC-445 or EC-446 master cylinder to the stock brake pedal in the stock master cylinder location on 47-54 Chevy 1/2 ton trucks. Supplied with pushrod, rod end, hardware and new boot. -0 **\$89.75 KIT** ⚠

**Master Cylinder Adapter Kit - Ford**

**EC-410** ..... 39-40  
Ford car master cylinder adapter for 67-72 Mustang master cylinder (our part EC-445) -0 **\$50.00 EA** ⚠

**EC-415** ..... 41-48  
Ford car master cylinder adapter for 67-72 Mustang master cylinder (our part EC-445) -0 **\$105.00 EA** ⚠

**EC-410A** ..... 48-52  
Ford truck 1/2 ton master cylinder adapter for 67-72 Mustang master cylinder (our part EC-445) -0 **\$50.00 EA** ⚠

**EC-450** ..... 49-51  
Ford car master cylinder adapter for 67-72 Mustang master cylinder (our part EC-445) -0 **\$265.00 EA** ⚠

**EC-412** ..... 57-62  
Ford 1/2 ton truck master cylinder adapter for 67-72 Mustang master cylinder (our part EC-445) -0 **\$95.00 EA** ⚠

**Master Cylinder**

**EC-520** ..... 35-40  
Ford dual master cylinder & 7" brake booster combo with pedal -0 **\$395.00 EA** ⚠

**EC-441** ..... 39-41  
Dodge and Plymouth passenger car, Mustang dual reservoir master cylinder & adapter -0 **\$310.00 EA** ⚠

**EC-520a** ..... 41-48  
Ford dual master cylinder & 7" brake booster combo with pedal -0 **\$395.00 EA** ⚠

**EC-442** ..... 46-48  
Dodge and Plymouth passenger car, Mustang dual reservoir master cylinder & adapter -0 **\$310.00 EA** ⚠



**EC-505** ..... 47-54  
New 7" booster & master cylinder assembly. Mounts in stock location using original brake pedal. Auto Trans only. 1/2 Ton only. -0.15 **\$425.00 KIT** ⚠

**EC-524** ..... 48-52  
Ford 1/2 Ton pickup dual master cylinder & 7" brake booster combo -0 **\$450.00 EA** ⚠

**EC-444** ..... 49-54  
Dodge and Plymouth passenger car Mustang dual reservoir master cylinder & adapter -0 **\$318.75 EA** ⚠

**EC-522** ..... 53-56  
Ford 1/2 ton pickup dual master cylinder & 7" brake booster combo for automatic -0 **\$450.00 EA** ⚠

**EC-600** ..... 55-64  
Chevy passenger car dual master cylinder & 7" brake booster combo -0 **\$310.00 EA** ⚠

**EC-608DD** ..... 55-64  
Chevy passenger car power 8" booster & master cylinder combo -0 **\$350.00 EA** ⚠

**EC-443** ..... 57-61  
Dodge and Plymouth bolt-on master cylinder. 1" bore, for disc brakes -0 **\$75.00 EA** ⚠

**Master Cylinder, cont.**



**EC-445** ..... ALL  
67-72 Mustang w/ 1" bore. disc/drum applications -0.15 **\$79.75 KIT** ⚠

**EC-446** ..... ALL  
NEW 67-76 Corvette w/ 1" bore. 4 wheel Disc apps. -0.15 **\$85.25 KIT** ⚠

**EC-5908DD** ..... ALL  
Universal under dash power brake mount w/ 8" dual diaphragm booster and master cylinder -0 **\$500.00 EA** ⚠

**EC-590M** ..... ALL  
Universal under dash manual brake mount w/ master cylinder -0 **\$310.00 EA** ⚠



**EC-590P** ..... ALL  
Universal under dash power brake mount w/ 7" booster and master cylinder -0 **\$425.00 EA** ⚠

**EC-5958DD** ..... ALL  
Universal firewall mounted power brake assembly w/ 8" dual diaphragm booster and master cylinder -0 **\$500.00 EA** ⚠

**EC-595M** ..... ALL  
Universal firewall mounted manual brake assembly w/ master cylinder -0 **\$310.00 EA** ⚠

**EC-595P** ..... ALL  
Universal firewall mounted power brake assembly w/ 7" booster and master cylinder -0 **\$450.00 EA** ⚠

**Power Brake Booster -Chevy**

Double diaphragm Chrome boosters fit most GM cars & trucks. Allows use of taller valve covers. Some modification may be required.



**R3907** ..... ALL  
Chrome power brake boosters - 7" double diaphragm. -0.15 **\$138.25 EA** ⚠

**Master Cylinder - Electric Boost**

Retrofit in place of the master cylinder in most American cars. Requires no vacuum or belt-driven pumps. Features 3 small components that can be mounted on the firewall or hidden under the vehicle. This is a 12-volt, electric high power master cylinder! Built-in accumulator if engine stalls for safe operation in emergencies. Available in 2 sizes, 2" x 10" and 2" x 8". Features all key components in one attractive housing.  
Call or visit our web site for your specific Firewall or Frame Mount application.



**ABS10-62** .....ALL  
Frame Mount 10" Master Cylinder -0.15  
..... \$1,530.00 EA ⚠



**ABS10-71** .....ALL  
Frame Mount 8" Master Cylinder -0.15  
..... \$1,530.00 EA ⚠

**Brake Residual Valve**

**EC-650** .....ALL  
2 Lbs. A must for applications where master cylinder is below calipers. 5.809 -0.15  
..... \$29.00 EA ⚠

**EC-655** .....ALL  
10 Lbs. A must for applications where master cylinder is below calipers. 5.809 -0.15  
..... \$29.00 EA ⚠

**RV02** ..... ALL  
2 Lbs. A must for applications where master cylinder is below calipers. 5.809 -0.15  
..... \$14.75 EA ⚠

**RV10** ..... ALL  
10 Lbs. A must for applications where master cylinder is below calipers. 5.809 -0.15  
..... \$14.75 EA ⚠

**Electric Parking Brake**



**ELECTRICPARK** .....ALL  
Electronic parking brake. Installs inline, eliminates handle and cables. 2.447 -0.15  
..... \$365.25 KIT ⚠

**Master Brake Cylinder Cover**



**R9255** .....ALL  
Chrome plastic late GM snap-on master cylinder brake cover. -0.15  
..... \$11.00 EA ⚠

**Brake Light Switch**



**EC-1600** .....ALL  
Inline brake light actuating assembly using a heavy duty electrical switch that has no exposure to the brake fluid in the system. This new assembly can be used to replace your existing hydraulic switch using a 1/8-NPT fitting, or can be directly installed into the brake line. -0 .. \$40.00 EA ⚠

**WASL08** .....ALL  
Mechanical switch w/ self cleaning contacts (prevents carbon buildup). Adjustable to fit a wide variety of vehicles. For 12v systems. Rated -10 amps. Waterproof. Stainless hardware, includes instructions. -0.15  
..... \$25.00 EA ⚠

**WASL08-700R4** ..ALL  
700R4 lockup/ brake switch w/ SPDT (single pole double throw) relay. When brakes are off, converter is locked up. When they're on, it's not. Great for light cars w/ lots of power. Simple, easy installation. -0.15  
..... \$45.00 EA ⚠

**Brake Light Switch T Fitting**

**652B** ..... ALL  
Add a hydraulic brake light switch to your 3/16" brake line. -0.4 .. \$9.75 EA ⚠  
**652C** ..... ALL  
Add a hydraulic brake light switch to your 1/4" brake line. -0 ..... CALL ⚠

**Emergency Brake Handle (Lokar) -Under Dash**

Emergency hand brakes are chromed steel or black powdercoated. Ratchet, cut gear plate & lock are heat treated for strength & safety.



**EHB-9200** .....ALL  
Billet aluminum handbrake assembly. Mounts under the dash. Ball-milled detail and finger grooves cut into handle. Brushed finish. Requires use of Lokar Connector Cable. 4.826 -0.15  
..... \$320.25 EA ⚠



**EHB-9200X** .....ALL  
Midnight Series. Billet aluminum handbrake assembly. Mounts under the dash. Ball-milled detail and finger grooves cut into handle. Black anodized. Requires use of Lokar Connector Cable. 4.826 -0.15  
..... \$310.79 EA ⚠

**Emergency Brake Pedal (Lokar) -Under Dash**



**EFB-9001** .....ALL  
Brushed finish billet aluminum with rubber pad. -0.15  
..... \$276.00 EA ⚠



**EFB-9001X** .....ALL  
Midnight Series. Black anodized billet aluminum with rubber pad. -0.15  
..... \$267.79 EA ⚠

**Emergency Brake Handle (Lokar) -Floor Mount**

Emergency hand brake is chromed steel. Ratchet, cut gear plate & lock are heat treated for strength & safety.



**EHB-7000F** .....ALL  
Floor mounted emergency hand brake. Special features include 4-point mounting capabilities for floor mount or side mount. Comes complete w/ clevis for installation w/ Lokar emergency brake cables. Hand brake measures 10in. from end to end. Chrome 4.826 -0.15  
..... \$143.19 EA ⚠

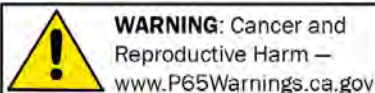

NOTE: Any chemicals will be shipped domestic ground only (Lower 48 states only). No international shipping.



**Emergency Brake Handle (Lokar)  
-Floor Mount, cont.**



**EHB-7000FX** .....ALL  
Midnight Series. Floor mounted emergency hand brake. Special features include 4-point mounting capabilities for floor mount or side mount. Comes complete w/ clevis for installation w/ Lokar emergency brake cables. Hand brake measures 10in. from end to end. Black Powdercoated. 4.826 -0.15  
..... **\$147.50 EA** ⚠

**Emergency Brake Handle (Lokar)  
-Trans Mount**

Transmount emergency hand brakes have special features including geometric design which allows for comfortable lever operation. Mounting hardware for use w/ Lokar Automatic Transmission Shifter is included w/ Transmount cable kits.



**EHB-7011** .....ALL  
11in. transmount emergency hand brake. Use w/ 16in. & shorter shifters. Chrome 4.826 -0.15  
..... **\$173.75 EA** ⚠



**EHB-7011X** .....ALL  
Midnight Series. 11in. transmount emergency hand brake. Use w/ 16in. & shorter shifters. Black powdercoated. 4.826 -0.15  
..... **\$174.00 EA** ⚠



**EHB-7016** .....ALL  
16in. transmount emergency hand brake. Use w/ 23in. shifters. 4.826 -0.15  
..... **\$173.75 EA** ⚠



**EHB-7016X** .....ALL  
Midnight Series. 16in. transmount emergency hand brake. Use w/ 23in. shifters. Black powdercoated. 4.826 -0.15  
..... **\$174.00 EA** ⚠

**Emergency Brake Boot (Lokar)**

Emergency hand brake boots are black Naugahyde & includes a billet aluminum ring w/ ball-milled edge or polished stainless ring. All sets include stainless screws. Top of boot hugs the handle shaft for a clean look. Available in floor mount or transmount style.



**70-BHBF** .....ALL  
Emergency hand brake (floor mount) boot with brushed finish billet retainer. 6-1/2" x 2-3/4". 4.826 -0.15  
..... **\$63.49 EA** ⚠



**70-BHBFX** .....ALL  
Midnight Series. Emergency hand brake (floor mount) boot with brushed finish billet retainer. 6-1/2" x 2-3/4". 4.826 -0.15  
..... **\$69.00 EA** ⚠



**70-BHBT** .....ALL  
Emergency hand brake (trans mount) boot with brushed finish billet retainer. 6-1/2" x 2-3/4". 4.826 -0.15  
..... **\$69.00 EA** ⚠



**70-BHBTX** .....ALL  
Midnight Series. Emergency hand brake (trans mount) boot with brushed finish billet retainer. 6-1/2" x 2-3/4". 4.826 -0.15  
..... **\$66.79 EA** ⚠



**70-EHBF** .....ALL  
Polished stainless floor mount emergency hand brake boot. 4.612 -0.15  
..... **\$32.50 EA** ⚠



**70-EHBT** .....ALL  
Polished stainless-transmount emergency hand brake boot. 4.612 -0.15  
..... **\$37.25 EA** ⚠

**Emergency Brake Cables (Lokar)**

Emergency brake cable kits are designed for use w/ Lokar's emergency hand brakes. Kits include bracket for mounting cable to hand brake and comes equipped w/ quality one-piece, aluminum adjusters & aluminum ferrule which eliminates fraying. Outer housing is Teflon lined for smooth operation. Stainless inner cable resists moisture. Design allows rear end backing plate fitting to be removed without removing brake cables and features adjustable cable lock & clevis. Kits include two 8 foot, cut-to-fit outer housings. Available in stainless or black housing.



**EC-8003HT** .....39-48  
Chevy car stainless connector cable for under-dash hand brake. 4.826 -0.15  
..... **\$143.19 EA** ⚠

**EC-8003U** .....39-48  
Chevy car black connector cable for under-dash hand brake. 4.862 -0.15  
..... **\$98.89 EA** ⚠



**EC-8004HT** .....42-54  
Chevy truck rear brake cable kit, stainless housing. Connects from two backing plates to middle connector. 4.833 -0.15  
..... **\$161.50 SET** ⚠



**EC-8004U** .....42-54  
Chevy truck rear brake cable kit, black housing. Connects from two backing plates to middle connector. 4.862 -0.15  
..... **\$129.75 SET** ⚠



**EC-8001HT** .....ALL  
Connector cable for foot or hand operated e-brake. Stainless housing. 6' foot cable. 4.862 -0.15  
..... **\$147.50 EA** ⚠

**EC-8001U** .....ALL  
Connector cable for foot or hand operated e-brake. Black housing. 6' foot cable. 4.862 -0.15  
..... **\$102.00 EA** ⚠

**Emergency Brake Cables (Lokar), cont.**



**EC-80FHT** ..... ALL  
Floor mount emergency brake cable kit, stainless housing. 4.862 -0.15

**EC-80FU** ..... ALL  
Floor mount emergency brake cable kit, black housing. 4.862 -0.15 . **\$161.50 EA** ⚠



**EC-80THT** ..... ALL  
Transmount emergency brake cable kit, stainless housing. 4.862 -0.15

**EC-80TU** ..... ALL  
Transmount emergency brake cable kit, black housing. 4.862 -0.15 . **\$161.50 EA** ⚠

**Emergency Brake - Clevis**



**EC-81FC** ..... ALL  
Ford Explorer Wilwood style. -0.15  
..... **\$37.00 PR** ⚠

**Line Clamps - Billet Specialties**



**BIS65110** ..... ALL  
3/16" single (4 clamps). 8.950 -0.15

**BIS65210** ..... ALL  
1/4" single (4 clamps). 8.950 -0  
..... **\$11.09 SET** ⚠

**BIS65310** ..... ALL  
5/16" single (4 clamps). 8.950 -0.15

**BIS65410** ..... ALL  
3/8" single (4 clamps). 8.950 -0

..... **\$12.00 SET** ⚠

**Line Clamps - Billet Specialties, cont.**



**BIS65510** ..... ALL  
1/2" single (4 clamps). 8.950 -0  
..... **\$12.99 SET** ⚠

**Line Clamp - Stainless**



**13274** ..... ALL  
3/16" single (12 clamps). 8.950 -0.15  
..... **\$17.00 SET** ⚠

**13277** ..... ALL  
1/4" single (12 clamps). 8.950 -0.15  
..... **\$16.99 SET** ⚠

**13278** ..... ALL  
5/16" single (12 clamps). 8.950 -0.15  
..... **\$18.25 SET** ⚠

**13279** ..... ALL  
3/8" single (12 clamps). 8.950 -0.15  
..... **\$18.25 SET** ⚠

**13280** ..... ALL  
1/2" single (12 clamps). 8.950 -0.15  
..... **\$16.99 SET** ⚠

**13281** ..... ALL  
5/8" single (8 clamps). 8.950 -0.15  
..... **\$16.99 SET** ⚠

**13282** ..... ALL  
3/4" single (8 clamps). 8.950 -0.15  
..... **\$16.99 SET** ⚠

**13283** ..... ALL  
7/8" single (8 clamps). 8.950 -0.15  
..... **\$16.99 SET** ⚠

..... **\$16.99 SET** ⚠



**13285** ..... ALL  
1/4" x 1/4" double (6 clamps). 8.950 -0.15  
..... **\$17.00 SET** ⚠

**13288** ..... ALL  
1/2" x 1/2" double (6 clamps). 8.950 -0.15  
..... **\$16.99 SET** ⚠

**13275** ..... ALL  
3/16" x 3/8" double combination (6 clamps). 8.950 -0.15 . . . . . **\$17.00 SET** ⚠

**Line Clamp - Stainless, cont.**

**13276** ..... ALL  
3/16" x 3/16" double (6 clamps).  
8.950 -0.15 . . . . . **\$17.00 SET** ⚠

**Line Clamp - Stainless, cont.**

**13284** ..... ALL  
5/16" x 3/8" double combination (6 clamps). 8.950 -0.15 . . . . . **\$16.99 SET** ⚠

**13286** ..... ALL  
5/16" x 5/16" double (6 clamps).  
8.950 -0.15 . . . . . **\$17.00 SET** ⚠

**13287** ..... ALL  
3/8" x 3/8" double (6 clamps). 8.950 -0.15  
..... **\$17.00 SET** ⚠

**13289** ..... ALL  
5/8" x 5/8" double (4 clamps). 8.950 -0.15  
..... **\$17.00 SET** ⚠

**13290** ..... ALL  
3/4" x 3/4" double (4 clamps). 8.950 -0.15  
..... **\$17.00 SET** ⚠

**13291** ..... ALL  
7/8" x 7/8" double (4 clamps). 8.950 -0.15  
..... **\$16.99 SET** ⚠

**Clamp**



**120521** ..... ALL  
1/4 in. bolt-on strap.  
For wire or tube (4 pcs).  
8.950 -0.4



..... **\$2.59 SET** ⚠  
**120521A** ..... ALL  
5/16 in, insulated bolt-on strap. For wire or tube (4 pcs). 8.950 -0.4

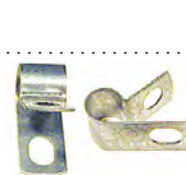

..... **\$3.29 SET** ⚠  
**120521B** ..... ALL  
3/8 in. bolt-on strap.  
For wire or tube (4 pcs).  
8.950 -0.4  
..... **\$2.79 SET** ⚠

**Line Separator**



**LC1735-D6** ..... ALL  
Stainless, 3/16" x 3/16" w/ 90 degree tab. Use for brake, fuel, ignition wire, cables, etc. 8.950 -0.15 . . . . . **\$16.99 EA** ⚠

**LC1737-D6** ..... ALL  
Stainless, 3/16" x 3/16". Use for brake, fuel, ignition wire, cables, etc. 8.950 -0.15  
..... **\$16.99 EA** ⚠

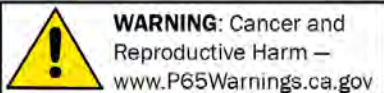

**WARNING: Cancer and Reproductive Harm** —  
www.P65Warnings.ca.gov

NOTE: Any chemicals will be shipped domestic ground only (Lower 48 states only). No international shipping.

**Electric Power Steering**



**FR40200** .....ALL  
Microsteer universal Electric Power Assisted Steering system. It can be easily fitted to virtually any vehicle, without the need to change steering rack or fit a hydraulic system where manual steering currently exists.

The unique Microsteer Tuning Box allows you to adjust the amount of assistance by using a rotary potentiometer or, if you prefer, you can make the system speed sensitive by connecting a wheel speed signal to the Tuning Box. A mode selection switch on the box allows you to choose your preferred method, manual or wheel speed.

If you have no wheel speed sensor on the vehicle, we recommend purchasing a Hall effect type sensor. This is not included in the kit and would need to be purchased separately. The input and output shafts of the Microsteer unit are 11/16"-36.

The Microsteer kit includes:  
Motor/Gearbox (MGU)  
Electronic Control Unit (ECU)  
Tuning Box  
Wiring Harness -0

..... \$990.00 EA ⚠



**FR40200S** .....ALL  
This speed sensor will need to be used in your manual steering system with our Microsteer Electric

Power Assisted Steering system installed if your vehicle does not have a speed signal present that you can use for the speed sensitive setup -0

..... \$70.00 EA ⚠

**Steering Rack - Power**



**C5RACK** .....39-54  
Power steering rack required for C5 CONV IFS conversion. -0.15 . \$675.00 EA ⚠

**Steering Rack - Power, cont.**



**MP-038-3-K** ..... ALL  
Mustang II power rack and pinion kit. Includes the rack, hardware and tie rod ends along with spacers. 6.008 -0  
..... \$583.75 EA ⚠

**Steering Rack & Pinion Kit**

Update your hot rod's steering system with a brand new Rack and Pinion Cradle Kit. Available in manual steering kits and power steering kits, these rack and pinion conversion systems are a direct-fit and include everything you need for installation.



**FR306KT** ..... 55-56  
Rack and pinion kit: Chevy 55-56 manual rack, cradle system w/floor shift. Mill finish column. -0 ..... \$1,435.49 EA ⚠

**FR306KTB** ..... 55-56  
Rack and pinion kit: Chevy 55-56 manual kit w/black powdercoat floor shift column. -0 ..... \$1,491.29 EA ⚠

**FR306KTNC** ..... 55-56  
Rack and pinion kit: Chevy 55-56 manual kit w/o column. -0.15 . \$1,332.59 EA ⚠

**FR306KTPL** ..... 55-56  
Rack and pinion kit: Chevy 55-56 manual rack and pinion cradle system w/polished floor shift column -0 . \$1,670.69 EA ⚠

**FR306NM** ..... 55-56  
Rack and pinion Kit: Chevy 55-56 manual cradle w/o column -0.15 ..... \$1,211.19 EA ⚠



**FR307KTPW** .....55-56  
Rack and pinion Kit: Chevy 55-56 power rack and pinion cradle system w/ floor shift mill finish column -0  
..... \$1,954.79 EA ⚠

**FR307KTPWNC** ..... 55-56  
Rack and pinion kit: Chevy 55-56 power rack and pinion kit w/o column. -0  
..... \$1,620.19 EA ⚠

**Steering Rack & Pinion Kit, cont.**

**FR307KTPWPL** ..... 55-56  
Rack and pinion kit: Chevy 55-56 power rack and pinion cradle system w/ floor shift polished column. -0  
..... \$2,201.49 EA ⚠



**FR309KT** ..... 55-56  
Rack and pinion kit: Chevy 55-56 manual rack and pinion cradle system w/ column shift mill finish column. -0  
..... \$1,785.89 EA ⚠

**FR309KTPL** ..... 55-56  
Rack and pinion kit: Chevy 55-56 manual rack and pinion cradle system w/ column shift polished column -0  
..... \$2,130.09 EA ⚠

**FR309KTPLIN** ..... 55-56  
Rack and pinion kit: Chevy 55-56 manual kit column shift with gear indicator. Polished column -0 .. \$2,050.09 EA ⚠



**FR309KTPW** .....55-56  
Rack and pinion kit: Chevy 55-56 power rack and pinion cradle system w/column shift, mill finish column. -0  
..... \$2,258.19 EA ⚠

**FR309KTPWINPL** ..... 55-56  
Rack and pinion kit: Chevy 55-56 power. Polished column with gear shift indicator. -0 ..... \$2,377.29 EA ⚠

**FR309KTPWNP** ..... 55-56  
Rack and pinion kit: Chevy 55-56 column shift column, no pump -0  
..... \$2,137.59 EA ⚠

**FR309KTPWPL** ..... 55-56  
Rack and pinion kit: Chevy 55-56 power rack and pinion cradle system w/ polished column shift column -0  
..... \$2,492.99 EA ⚠



**FR314KT1** ..... 55-57  
Rack and pinion kit: T-bird 55-57 power. Includes Floor shift column for aftermarket steering wheels -0 .. \$3,345.39 EA ⚠

**Steering Rack & Pinion Kit, cont.**

**FR314KT1PL** ..... 55-57  
Rack and pinion kit: T-bird 55-57 power. Includes floor shift polished column for original steering wheel. -0

..... \$3,572.59 EA ⚠

**FR314KT2** ..... 55-57  
Rack and pinion kit: T-bird 55-57 power. Includes floor shift mill finish column for original steering wheel. -0

..... \$3,487.79 EA ⚠

**FR314KT2PL** ..... 55-57  
Rack and pinion kit: T-bird 55-57 power. Includes floor shift polished column for original steering wheel. -0

..... \$3,720.19 EA ⚠

**FR307NP** ..... 57  
Rack and pinion kit: Chevy 57 power cradle without column. -0

..... \$1,630.09 EA ⚠



**FR308KT** ..... 57  
Rack and pinion kit: Chevy 1957 manual rack and pinion cradle system w/ floor shift mill finish column. -0

..... \$1,438.89 EA ⚠

**FR308KTNC** ..... 57  
Rack and pinion kit: Chevy 1957 manual kit without column. -0.15

..... \$1,332.59 EA ⚠

**FR308KTPL** ..... 57  
Rack and pinion kit: Chevy 57 manual rack and pinion cradle system w/ floor shift polished column. -0.15

..... \$1,733.79 EA ⚠



**FR308KTPW** ..... 57  
Rack and pinion kit: Chevy 57 power rack and pinion cradle system w/ floor shift mill finish column. -0

..... \$2,137.89 EA ⚠

**FR308KTPWPL** ..... 57  
Rack and pinion kit: Chevy 1957 power rack and pinion cradle system w/ floor shift polished column -0

..... \$2,377.29 EA ⚠

**Steering Rack & Pinion Kit, cont.**



**FR310KT** ..... 57  
Rack and pinion kit: Chevy 57 manual rack and pinion cradle system w/ column shift mill finish column. -0

..... \$1,876.59 EA ⚠

**FR310KTPL** ..... 57  
Rack and pinion kit: Chevy 57 manual rack and pinion cradle system w/ column shift polished column. -0

..... \$2,028.29 EA ⚠



**FR311KTPW** ..... 57  
Rack and pinion kit: Chevy 57 power rack and pinion cradle system w/ column shift mill finish column. -0

..... \$2,260.09 EA ⚠

**FR311KTPWNC** ..... 57  
Rack and pinion kit: Chevy 57 power rack kit without column -0

..... \$1,614.69 EA ⚠

**FR311KTPWPL** ..... 57  
Rack and pinion kit: Chevy 57 power rack and pinion cradle system w/ column shift polished column -0

..... \$2,492.99 EA ⚠



**FR331KT** ..... 58-60  
Rack and pinion kit: Impala 58-60 small block power rack w/ floor shift mill finish column -0

..... \$2,474.29 EA ⚠

**FR331KTNCNP** ..... 58-60  
Rack and pinion kit: Impala 58-60 power, no column, no pump -0

..... \$2,126.29 EA ⚠

**FR331KTNP** ..... 58-60  
Rack and pinion kit: Impala 58-60 small block power w/ floor shift mill finish column, no pump -0

..... \$2,364.59 EA ⚠

**Steering Rack & Pinion Kit, cont.**

**FR331KTPL** ..... 58-60  
Rack and pinion kit: Impala 58-60 small block power w/ floor shift polished column. -0

..... \$2,703.29 EA ⚠

**FR332KT** ..... 58-60  
Rack and pinion kit: Impala 58-60 small block power w/ column shift mill finish column -0

..... \$2,706.09 EA ⚠

**FR332KTPL** ..... 58-60  
Rack and pinion kit: Impala 58-60 small block power rack w/ column shift column polished. -0

..... \$3,055.09 EA ⚠

**FR334KT** ..... 58-60  
Rack and pinion kit: Impala 58-60 small block manual with floor shift mill finish column. -0

..... \$1,903.59 EA ⚠

**FR335KT** ..... 58-60  
Rack and pinion kit: Impala 58-60 small block manual with column shift mill finish column. -0

..... \$2,239.89 EA ⚠

**FR337KT** ..... 58-60  
Rack and pinion kit: Impala 58-60 big block power with floor shift mill finish column. -0

..... \$2,474.29 EA ⚠

**FR337KTNP** ..... 58-60  
Rack and pinion kit: Impala 58-60 big block power with floor shift mill finish column, no pump. -0

..... \$2,366.99 EA ⚠

**FR337KTPL** ..... 58-60  
Rack and pinion kit: Impala 58-60 big block power with floor shift polished column. -0

..... \$2,703.29 EA ⚠

**FR338KT** ..... 58-60  
Rack and pinion kit: Impala 58-60 big block power with column shift mill finish column. -0

..... \$2,832.49 EA ⚠

**FR340KT** ..... 58-60  
Rack and pinion kit: Impala 58-60 big block manual with floor shift mill finish column. -0

..... \$1,903.59 EA ⚠

**FR341KT** ..... 58-60  
Rack and pinion kit: Impala 58-60 big block manual with column shift column. -0

..... \$2,239.89 EA ⚠



**FR317KT** ..... 60-64  
Rack and pinion kit: Galaxie & full size Ford 60-64 with mill finish column. -0

..... \$2,163.89 EA ⚠

**FR317KTPL** ..... 60-64  
Rack and pinion kit: Galaxie & full size Ford 60-64 with polished column -0

..... \$2,471.39 EA ⚠

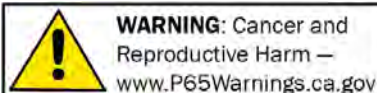

NOTE: Any chemicals will be shipped domestic ground only (Lower 48 states only). No international shipping.

**Steering Rack & Pinion Kit, cont.**



- FR343KT** ..... 61-62  
Rack and pinion kit: Impala 61-62 small block power with floor shift mill finish column -0 ..... \$2,474.29 EA ⚠
- FR344KT** ..... 61-62  
Rack and pinion kit: Impala 61-62 small block power with column shift mill finish column -0 ..... \$2,832.49 EA ⚠
- FR344KTPLNP** ..... 61-62  
Rack and pinion Kit: Impala 61-62 small block power with column shift polished column, no pump -0 ..... \$2,703.29 EA ⚠
- FR346KT** ..... 61-62  
Rack and Pinion Kit: Impala 61-62 small block manual with floor shift mill finish column. -0 ..... \$1,903.59 EA ⚠
- FR347KT** ..... 61-62  
Rack and pinion kit: Impala 61-62 small block manual with column shift mill finish column -0 ..... \$2,239.89 EA ⚠
- FR349KT** ..... 61-62  
Rack and pinion kit: Impala 61-62 big block power with floor shift mill finish column -0 ..... \$2,474.29 EA ⚠
- FR350KT** ..... 61-62  
Rack and pinion kit: Impala 61-62 big block power with column shift mill finish column -0 ..... \$2,832.49 EA ⚠
- FR352KT** ..... 61-62  
Rack and pinion kit: Impala 61-62 big block manual with floor shift mill finish column -0 ..... \$1,903.59 EA ⚠
- FR353KT** ..... 61-62  
Rack and pinion kit: Impala 61-62 big block manual with column shift mill finish column -0 ..... \$2,239.89 EA ⚠
- FR355KT** ..... 63-64  
Rack and pinion Kit: Impala 63-64 small block power with floor shift mill finish column -0 ..... \$2,474.29 EA ⚠
- FR355KTNC** ..... 63-64  
Rack and pinion kit: Impala 63-64 small block power, no column -0 ..... \$2,075.09 EA ⚠
- FR355KTPL** ..... 63-64  
Rack and pinion kit: Impala 63-64 small block power with floor shift polished column -0 ..... \$2,710.49 EA ⚠
- FR356KT** ..... 63-64  
Rack and pinion kit: Impala 63-64 small block power with column shift mill finish column -0 ..... \$2,832.49 EA ⚠

**Steering Rack & Pinion Kit, cont.**

- FR356KTPL** ..... 63-64  
Rack and pinion kit: Impala 63-64 small block power with column shift polished column -0 ..... \$3,055.09 EA ⚠
- FR356KTPLNP** ..... 63-64  
Rack and pinion kit: Impala 63-64 small block power with column shift polished column, no pump -0 ..... \$2,936.49 EA ⚠
- FR358KT** ..... 63-64  
Rack and pinion kit: Impala 63-64 small block manual rack with floor shift mill finish column -0 .. \$1,903.59 EA ⚠
- FR359KT** ..... 63-64  
Rack and pinion kit: Impala 63-64 small block manual rack with column shift mill finish column -0 .. \$2,239.89 EA ⚠
- FR361KT** ..... 63-64  
Rack and pinion kit: Impala 63-64 big block power rack with floor shift mill finish column -0 ..... \$2,478.19 EA ⚠
- FR361KTNPNC** ..... 63-64  
Rack and pinion kit: Impala 63-64 big block power rack kit, no column, no pump -0.15 ..... \$2,126.59 EA ⚠
- FR362KT** ..... 63-64  
Rack and pinion kit: Impala 63-64 big block power with column shift mill finish column -0 ..... \$2,832.49 EA ⚠
- FR364KT** ..... 63-64  
Rack and pinion kit: Impala 63-64 big block manual rack with floor shift mill finish column -0 .. \$1,903.59 EA ⚠
- FR365KT** ..... 63-64  
Rack and pinion kit: Impala 63-64 big block manual rack with column shift mill finish column -0 .. \$2,239.89 EA ⚠

**Borgeson Power Steering Conversion Kits**



- 5880723** ..... 47-59  
Chevy truck. For late model 1969-87 Chevy 2WD Saginaw steering box with 13/16" 36 spline input shaft.
- Note: if you have a steering box with 3/4" 30 spline, use our u-joint part number FR1733DD. 6859.000 -0 .. \$297.79 SET ⚠

**Borgeson Power Steering Conversion Kits, cont.**



- 800115** ..... 52-64  
Power steering conversion, 52-64 full-sized Ford cars -0.15  
..... \$607.49 EA ⚠



- 999005** ..... 55-57  
Chevy power steering kit, 1955-1957 Chevy with 3/4-36 Column and small block with short water pump -0.15 ..... \$983.00 EA ⚠
- 999006** ..... 55-57  
Chevy power steering kit, 1955-1957 Car -0.15 ..... \$983.00 EA ⚠
- 999007** ..... 55-57  
Chevy power steering kit, 1955-1957 Chevy with 3/4-36 Column and small block chevy with long water pump. -0.15 ..... \$983.00 EA ⚠
- 999008** ..... 55-57  
Chevy power steering kit, 1955-1957 Chevy with 1"DD Column and small block with long water pump. -0.15 ..... \$983.00 EA ⚠
- 999009** ..... 55-57  
Chevy power steering kit, 1955-1957 Chevy with 3/4-36 column and small block chevy /FMM -0.15 .. \$991.00 EA ⚠
- 999010** ..... 55-57  
Chevy power steering kit, 1955-1957 Chevy with 1"DD column and small block chevy /FMM -0.15 ..... \$991.00 EA ⚠
- 999011** ..... 55-57  
Chevy power steering kit, 1955-1957 Chevy with 3/4-36 column and big block chevy with short water pump -0.15 ..... \$983.00 EA ⚠
- 999012** ..... 55-57  
Chevy power steering kit, 1955-1957 Chevy with 1"DD column and big block chevy with short water pump -0.15 ..... \$983.00 EA ⚠



## Reference Application Chart

Six Easy Steps to Ordering a Steering System:

1. Choose the type of intermediate shaft you will be using (splined or DD). This is one side of the u-joint that you will need to order.
2. Determine whether you will need a two or three U-joint system. This is dictated by the angle; we recommend a 15° angle for the optimum system, however up to a 30° is acceptable. If using a three u-joint system, a support bearing is necessary. The center u-joint will either be 3/4"DD x 3/4"DD or 3/4"-36 x 3/4"-36, depending on whether you are using splined or DD shafts.
3. Use the reference application chart to select the rack and pinion or box spline size you require. If the chart does not list your application, just measure the diameter of the shaft and count the number of splines. If there is a flat, count half the splines and double this number.
4. Measure your column. If DD (two rounds, two flats), measure the Rounds - it will either be 1"DD or 3/4"DD. If splined, measure the diameter and count the splines (i.e. 1"-48 or 3/4"-36.)
5. If you are using splined shafting and a two u-joint system, measure the distance between the rack and pinion or box shaft and the column, and then subtract 3.25 inches. Round this number up to the next shaft size.
6. If you are using a three-joint system, we recommend using dowel rods to mock up the system. Just measure the length of the dowel rod and this will be the length of your shaft. DD can easily be cut to this size.



### Important Notes:

- Phasing - Keep the forks of the yokes closest to each other in line, and parallel to the center of the shaft to avoid binding.
- NEVER WELD a universal joint. Welding reduces the strength of the metal and can melt the needle bearing seal.
- Set screws are supplied on all splined and "Double D" u-joints. However, it is necessary to indent, by drilling, the shaft to properly secure the set-screw mechanism. A red threadlocker should also be used. Inspect set screws periodically.
- The shaft should be installed 7/8 inch into the yoke (flush). A shaft that does not engage fully could sacrifice strength. However, if it is too long, it will cause the shaft to interfere (bind) with the operation of the u-joint.

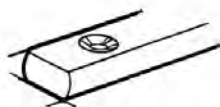

### MEASURING FOR YOUR TILT COLUMN

$$7\text{-}9/16 \text{ in. Shroud Length} + \text{Distance to Firewall} + 3 \text{ in. Shaft through Firewall} = \text{Your Desired Column Length}$$

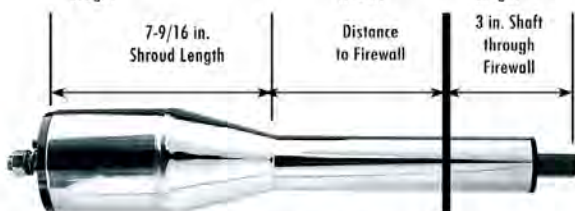

Your Desired Column Length

1 inch DD Tube; Floor Shift 1-3/4 inch dia. Column Shift 2 inch dia.

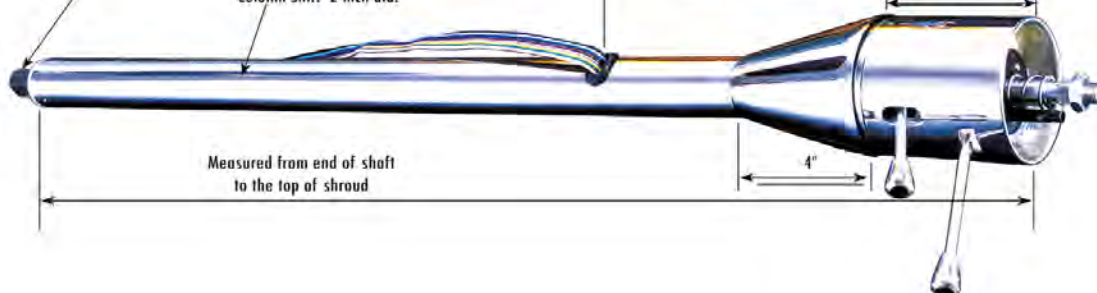

Application	Size	Spline Dia.	Splines
<b>Ford Rack</b>			
Mustang II & Pinto Manual	9/16"-26	.563	26
Mustang II & Pinto Power	3/4"-36	.750	36
<b>Ford Box</b>			
Manual & Power	3/4"-36	.750	36
<b>GM Box Manual</b>			
Vega	5/8"-36	.625	36
Corvaire	5/8"-36	.625	36
Corvette (63-68)	3/4"-36	.750	36
Corvette (69-82)	3/4"-30	.750	30
Model 122 (65-85)	3/4"-30	.750	30
	3/4"-36	.750	36
Model 525 (86-Present)	3/4"-30	.750	30
<b>GM Power Box</b>			
Model 605 (78-84)	3/4"-30	.750	30
Model 800 (77-Prior)	13/16"-36	.813	36
Model 800 (78-Present)	3/4"-30	.750	30
<b>GM Rack</b>			
79 - Present	5/8"-36	.625	36
Variations	3/4"-30	.750	30
Corvette (84 - Present)	17mm DD	.670	.570
Fiero	17mm DD	.670	.570
<b>Chrysler Box or Rack</b>			
Chrysler - Omni Manual	9/16"-26	.563	26
Chrysler - Omni Power	9/16"-36	.563	36
Chrysler - Volare	5/8"-36	.625	36
Chrysler	3/4"-36	.750	36
Chrysler	13/16"-36	.813	36

### Steering Column

Application	Size	Spline Dia.	Splines
<b>GM Column</b>			
Small Spline	3/4"-36	.750	36
Large Spline	1"-48	1.00	48
Small "DD"	3/4"-DD	.750	DD
Large "DD"	1"-DD	1.00	DD
<b>Ford Column</b>			
Small Spline	3/4"-DD	.750	36
Small "DD"	1"-48	1.00	.550
Large "DD"	DD	.750	.790

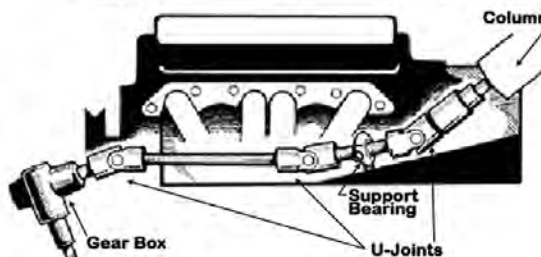

1-3/4 inch dia. Column Wiring Slot is 12-1/2 inches  
2 inch dia. Column Wiring Slot is 16-1/2 inches  
Note: Thread size on tilt shaft is M14 x 1.5"

NOTE: Any chemicals will be shipped domestic ground only (Lower 48 states only). No international shipping.

**Borgeson Power Steering Conversion Kits, cont.**



**999014** .....58-64  
Complete conversion kit, 58-64 Chevy, small block chevy with short water pump. -0.15 ..... **\$877.00 EA** ⚠

**Pitman Arm Chevy Truck**



**5880723S** .....47-54

Power steering conversion kit, for stock suspension. Fits

1969-87 Chevy 2WD truck power steering box with a 13/16"-36 spline input shaft. 6859.000 -0.15

..... **\$91.00 EA** ⚠

**Tilt Steering Columns -Column Shift (Flaming River)**

Flaming River now manufactures an all new column shift, tilt steering column. All new components have been engineered by Flaming River to incorporate state-of-the-art technology in this nostalgic design. Each column comes complete with gear shift arm, stainless steel dress up kit, illuminated gearshift indicator (not available for keyed columns) and GM wiring (4-1/4 connector) and a removable 12 position linkage arm with each column for easy alignment. Shaft size is 1 DD 2 tube diameter.



**FR20020** .....ALL

2" o.d. x 28" length. Steel finish (paintable). 4.007 -0 ..... **\$641.00 EA** ⚠

**FR20020PL** ..... ALL

2" o.d. x 28" length. Chrome & stainless steel finish. 4.007 -0 ..... **\$821.99 EA** ⚠

**FR20021** ..... ALL

2" o.d. x 30" length. Steel finish (paintable). 4.007 -0 ..... **\$692.75 EA** ⚠

**FR20021PL** ..... ALL

2" o.d. x 30" length. Chrome & stainless steel finish. 4.007 -0.15 ..... **\$861.50 EA** ⚠

**Tilt Steering Columns -Floor Shift (Flaming River)**



**FR20000** .....ALL

1-3/4" o.d. x 28" length. Steel finish (paintable). 4.007 -0 ..... **\$445.25 EA** ⚠

**FR20000SS** ..... ALL

1-3/4" o.d. x 28" length. Polished, stainless steel finish. 4.007 -0.15 ..... **\$628.00 EA** ⚠

**FR20001** ..... ALL

1-3/4" o.d. x 30" length. Steel finish (paintable). 4.007 -0 ..... **\$403.69 EA** ⚠

**FR20001SS** ..... ALL

1-3/4" o.d. x 30" length. Polished, stainless steel finish. 4.007 -0 ..... **\$569.00 EA** ⚠

**FR20005** ..... ALL

2" o.d. x 30" length. Steel finish (paintable). 4.007 -0 ..... **\$423.89 EA** ⚠

**FR20005-28SS** ..... ALL

2" o.d. x 28" length. Polished, stainless steel finish. 4.007 -0 ..... **\$569.00 EA** ⚠

**FR20005SS** ..... ALL

2" o.d. x 30" length. Polished, stainless steel finish. 4.007 -0 ..... **\$593.50 EA** ⚠

**Shift Indicator For Flaming River Columns**



**FR20010-KIT** .....ALL

Black ABS housing w/ pointer. 4.007 -0.15 ..... **\$109.00 EA** ⚠

**FR20010-KITC** ..... ALL

Chrome ABS housing w/ pointer. 4.007 -0.15 ..... **\$149.00 EA** ⚠

**FR20010-OVKIT** ..... ALL

Black ABS overdrive housing w/ pointer. 4.007 -0.15 ..... **\$106.00 EA** ⚠

**FR20010-OVKITC** ..... ALL

Chrome ABS overdrive housing w/ pointer. 4.007 -0.15 ..... **\$146.00 EA** ⚠

**Tilt Column Wiring Accessories (Flaming River)**

**FR20118** ..... ALL

Plug adapter kit, female plug. Supplied with terminals. Can be used to adapt any existing wiring harness to mate with 4-1/4" connector. 2.555 -0

..... **\$23.49 EA** ⚠

**Tilt Column Wiring Accessories (Flaming River), cont.**



**FR20118-1** .....ALL

Flasher kit used for classic vehicles that did not come equipped with 4-ways. Includes flasher, female adapter & terminals. 2.555 -0.15 ..... **\$110.00 EA** ⚠



**FR20118-2** .....ALL

Plug adapter-horseshoe shaped connector used in 67-68 Camaro. (Plug adapter FR20118 could be used in place of this adapter). 2.555 -0.15 ..... **\$75.00 EA** ⚠

**Steering Column Drop (Flaming River)**

Flaming Rivers Column Drops are machined from billet aluminum with a smooth radius edge. This sleek design is available in satin or mirror finish.



**FR20102** .....ALL

2-1/2" drop for 1-3/4" column, satin finish. 6.761 -0 ..... **\$102.99 EA** ⚠

**FR20102PL** ..... ALL

2-1/2" drop for 1-3/4" column, polished finish. 6.761 -0 ..... **\$107.50 EA** ⚠

**FR20103** ..... ALL

3-1/2" drop for 1-3/4" column, satin finish. 6.761 -0 ..... **\$103.00 EA** ⚠

**FR20103PL** ..... ALL

3-1/2" drop for 1-3/4" column, polished finish. 6.761 -0 ..... **\$103.00 EA** ⚠

**FR20107** ..... ALL

2-1/2" drop for 2" column, satin finish. 6.761 -0 ..... **\$105.39 EA** ⚠

**FR20107PL** ..... ALL

2-1/2" drop for 2" column, polished finish. 6.761 -0 ..... **\$107.00 EA** ⚠

**FR20108** ..... ALL

3-1/2" drop for 2" column, satin finish. 6.761 -0 ..... **\$103.00 EA** ⚠

# Section 190: Steering Columns, Steering Wheels, Shafts, Rebuild Kits, Steering Components & Related

## Steering Column Drop (Flaming River), cont.

**FR20108PL** ..... ALL  
3-1/2" drop for 2" column, polished finish. 6.761-0 ..... **\$105.39 EA** ⚠

## Column Shift Floor Mounts (Flaming River)



**FR20100CVR** .... ALL  
Floor mount firewall cover. Polished aluminum cover to finish the engine side column of the floor mount. 6.758-0.15 ..... **\$66.49 EA** ⚠

## Column Floor Mounts (Flaming River)

Billet Aluminum Ball and Collar swivel design floor mount simplifies column installation by allowing up to a 60 degree angle.



**FR20100** ..... ALL  
1-3/4" floor shift. 6.758-0 ..... **\$108.00 EA** ⚠

**FR20101** ..... ALL  
2" column shift. 6.758-0 ..... **\$109.89 EA** ⚠

## Steering Column Trim Plate



**WASB03N** ..... ALL  
Give your column the finished look with our machined aluminum trim with heavy duty rubber seal. Made with StreetWorks unique Split 'n' Pinned design for easy installation - no column removal required. The ring measures 3.420" I.D. and 4.800" O.D. and includes stainless steel mounting screws. The rubber seal has an opening to fit GM and other columns measuring 1-3/4" to approximately 2-1/8" diameter. Some trimming may be required for larger diameters. Comes with an additional grommet to fit 1-1/2" diameter columns. -0.15 ..... **\$42.00 EA** ⚠

## Column Shifter - Billet Aluminum



**R6063** ..... ALL  
Billet Aluminum GM Shifter. Fits 1967-94 -0.15 ..... **\$51.50 EA** ⚠

## Gearshift Arm (Flaming River)



**FRGSARM** ..... ALL  
Straight gearshift arm for Flaming River columns. 4.038-0 ..... **\$46.50 EA** ⚠



**FRGSARM-OF** ..... ALL  
Offset gearshift arm. 4.038-0 ..... **\$47.49 EA** ⚠

## Steering Column - Swing Away Kit

This kit enables you to mount a steering column and swing it to the side when getting in or out of your vehicle. Includes bracket and swivel floor mount. A column and/ or column drop must be purchased separately. Can be used with your existing column.



**FR1622** ..... ALL  
2 in. dia. column. -0.15 ..... **\$335.50 EA** ⚠

## Steering Column Dress Kits (Billet Specialties)



**BIS26120BLK** ... ALL  
Billet aluminum. GM early model columns (dimmer on floor). 6.758-0 ..... **\$32.59 SET** ⚠

## Column Dress Kits (Billet Specialties), cont.



**BIS26120** ..... ALL  
Billet aluminum. GM early model columns (dimmer on floor). 6.758-0.15 ..... **\$37.00 SET** ⚠



**BIS26320** ..... ALL  
Billet aluminum. †GM late model columns (dimmer on column). 6.758-0.15 ..... **\$32.00 SET** ⚠

## Column Dress Kits



**R6062** ..... ALL  
Billet Aluminum for Chevy/ GM columns. Includes turn signal, emergency knob & tilt lever. -0.15 ..... **\$22.00 SET** ⚠

## Steering Shaft Support Bearing



**FR1810** ..... ALL  
3/4 in., zinc plated for steering systems with multiple joints. Fits splined or DD shafts. 5.548-0.15 ..... **\$43.75 EA** ⚠

## Steering Shaft-Billet (Flaming River)

These billet shafts use a pre-ground alloy steel for strength and cosmetics. Available with electroless nickel plating for corrosion resistance.

There are two types of intermediate shaft systems: Splined (3/4-36) or DD. Either shafting is ideal for your steering system. Splined shafts allow a more precise adjustment. DD can only be phased 180 degrees. The advantage to DD is that it can be cut to any length eliminating the need to premeasure. You will need to choose which shafting you will be using prior to ordering the universal joints, since one side accommodates the shaft. Splined shafts have two inches of spline on each side that can be easily trimmed one inch per side. DD shafts are available in two lengths which can be cut to size.

**FR1850** ..... ALL  
DD 18 in. shaft, unplated. 5.548-0.15 ..... **\$62.00 EA** ⚠



**WARNING:** Cancer and Reproductive Harm — [www.P65Warnings.ca.gov](http://www.P65Warnings.ca.gov)

NOTE: Any chemicals will be shipped domestic ground only (Lower 48 states only). No international shipping.

(800) 952-1752 • [www.streetrodhq.com](http://www.streetrodhq.com)



# Section 190: Steering Columns, Steering Wheels, Shafts, Rebuild Kits, Steering Components & Related

## Steering Shaft-Billet (Flaming River), cont.

- FR1851** ..... ALL  
DD 36 in. shaft, unplated. 5.548-0.15  
..... **\$91.75 EA** ⚠
- FR1870-XPL** ..... ALL  
Splined shaft in 2 in. increments (4 in. to 16 in.) plated. 5.548-0  
..... **\$89.25 EA** ⚠
- FR1871-XXPL** ..... ALL  
Splined shaft in 2 in. increments (18 in. to 22 in.) plated. 5.548-0.15  
..... **\$82.00 EA** ⚠

## Steering Shaft-Stainless (Flaming River)

Stainless Steel shafts are manufactured from high quality 303 stainless.



- FR1850SSPL** ..... ALL  
Polished stainless steel shafts, 18" DD.  
5.548-0.15 ..... **\$105.29 EA** ⚠
- FR1851SSPL** ..... ALL  
Polished stainless steel shafts, 36" DD.  
5.548-0 ..... **\$168.50 EA** ⚠
- FR1870-XSS** ..... ALL  
Polished stainless steel shafts splined in 2 in. increments (4 in. to 16 in.). 5.548-0  
..... **\$89.25 EA** ⚠
- FR1871-XXSS** ..... ALL  
Polished stainless steel shafts splined in 2 in. increments (18 in. to 22 in.).  
5.548-0.15 ..... **\$82.00 EA** ⚠

## U-Joints - Stainless Steering Box (Flaming River)

Flaming Rivers Stainless Steel U-joints are made with 303 Stainless Steel for its strength, superior corrosion resistance & shine. The stainless steel joints have such a precision machined finish that they look pretty right out of the box. Add some polishing & they are gorgeous!



- FR1712DD** ..... ALL  
Stainless Steel 1"-48 Spline X 3/4" DD  
5.548-0.15 ..... **\$97.00 EA** ⚠
- FR2425PL** ..... ALL  
3/4" -30 spline box, 3/4" -36 splined shaft (polished). 5.548-0 ..... **\$127.69 EA** ⚠

## U-Joints - Stainless Steering Box (Flaming River), cont.

- FR2508** ..... ALL  
9/16" -26 spline box, 3/4" -36 splined shaft. 5.548-0.15 ..... **\$106.99 EA** ⚠
- FR2508PL** ..... ALL  
9/16" -26 spline box, 3/4" -36 splined shaft (polished). 5.548-0 ..... **\$127.75 EA** ⚠
- FR2511** ..... ALL  
3/4" -36 spline box, 3/4" -36 splined shaft. 5.548-0.15 ..... **\$106.99 EA** ⚠
- FR2511PL** ..... ALL  
3/4" -36 spline box, 3/4" -36 splined shaft (polished). 5.548-0 ..... **\$127.69 EA** ⚠
- FR2515DD** ..... ALL  
3/4" -36 spline box, 3/4" DD shaft.  
5.548-0.15 ..... **\$112.50 EA** ⚠
- FR2515DDPL** ..... ALL  
3/4" -36 spline box, 3/4" DD shaft (polished). 5.548-0 ..... **\$127.69 EA** ⚠
- FR2522DD** ..... ALL  
5/8" -36 spline box, 3/4" DD shaft.  
5.548-0.15 ..... **\$106.99 EA** ⚠
- FR2526** ..... ALL  
5/8" -36 splined shaft box, 3/4" -36 splined shaft. 5.548-0.15 ..... **\$106.99 EA** ⚠
- FR2526PL** ..... ALL  
5/8" -36 splined shaft box, 3/4" -36 splined shaft (polished). 5.548-0 ..... **\$127.69 EA** ⚠

## U-Joints - Stainless Steering Column (Flaming River)



- FR1716DD** ..... ALL  
3/4 in. DD column, 3/4 in. DD shaft.  
5.548-0.15 ..... **\$97.00 EA** ⚠
- FR2514DD** ..... ALL  
1" DD column, 3/4" -36 splined shaft.  
5.548-0.15 ..... **\$106.99 EA** ⚠
- FR2517DD** ..... ALL  
1" DD column, 3/4" DD shaft. 5.548-0.15  
..... **\$106.99 EA** ⚠
- FR2517DDPL** ..... ALL  
1" DD column, 3/4" DD shaft (polished).  
5.548-0 ..... **\$132.00 EA** ⚠

## U-Joints - Billet-Joint Steering Box (Flaming River)

- The Billet-Joint U-Joints are CNC machined from aircraft steel to precision tolerances. The sealed needle bearing design will last ten times longer than a standard pin & block universal joint. The unique nickel plating prevents rust without the hassle of painting.
- FR1708** ..... ALL  
9/16 in. -26 spline box, 3/4 in. -36 shaft.  
5.548-0 ..... **\$86.00 EA** ⚠

## U-Joints - Billet-Joint Steering Box (Flaming River), cont.

- FR1708PL** ..... ALL  
9/16 in. -26 spline box, 3/4 in. -36 shaft (polished). 5.548-0 ..... **\$109.00 EA** ⚠



- FR1709DD** ..... ALL  
9/16 in. -26 spline box, 3/4 in. DD shaft.  
5.548-0.15 ..... **\$97.00 EA** ⚠



- FR1712DDPL** ..... ALL  
Polished Billet 1" -48 Spline X 3/4" DD  
5.548-0.15 ..... **\$118.50 EA** ⚠
- FR1715DD** ..... ALL  
3/4 in. -36 spline box, 3/4 in. DD shaft.  
5.548-0 ..... **\$85.59 EA** ⚠
- FR1715DDPL** ..... ALL  
3/4 in. -36 spline box, 3/4 in. DD shaft (polished). 5.548-0 ..... **\$115.29 EA** ⚠
- FR1722DD** ..... ALL  
5/8 in. -36 spline box, 3/4 in. DD shaft.  
5.548-0 ..... **\$86.00 EA** ⚠
- FR1722DDPL** ..... ALL  
5/8 in. -36 spline box, 3/4 in. DD shaft (polished). 5.548-0 ..... **\$109.00 EA** ⚠
- FR1724PL** ..... ALL  
3/4 in. -30 spline box, 3/4 in. -36 shaft (polished). 5.548-0 ..... **\$109.00 EA** ⚠
- FR1726** ..... ALL  
5/8 in. -36 spline box, 3/4 in. -36 shaft.  
5.548-0 ..... **\$86.00 EA** ⚠
- FR1726DDPL** ..... ALL  
5/8 in. -36 spline box 3/4 in. -36 shaft (polished). 5.548-0 ..... **\$109.00 EA** ⚠
- FR1733DD** ..... ALL  
3/4 in. -30 spline box, 3/4 in. DD shaft.  
5.548-0 ..... **\$87.49 EA** ⚠

## U-Joints - Billet-Joint Steering Column (Flaming River)

- FR1707DD** ..... ALL  
1 in. DD column, 3/4 in. Shaft. 5.548-0  
..... **\$86.00 EA** ⚠
- FR1707DDPL** ..... ALL  
1 in. DD column, 3/4 in. shaft (polished).  
5.548-0 ..... **\$109.00 EA** ⚠
- FR1714DD** ..... ALL  
1 in. DD column, 3/4 in. -36 shaft.  
5.548-0.15 ..... **\$95.50 EA** ⚠
- FR1717DD** ..... ALL  
1 in. DD column, 3/4 in. DD shaft. 5.548-0  
..... **\$90.99 EA** ⚠

Returns require a return authorization number—Please call first. · Note: Product pricing and availability subject to change.

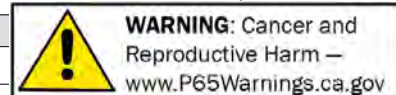

**U-Joints - Billet-Joint Steering Column (Flaming River), cont.**

**FR1717DDPL** ..... ALL  
1 in. DD column, 3/4 in. DD shaft (polished). 5.548-0 ..... **\$109.00 EA** ⚠

**FR1746DD** ..... ALL  
1 in. DD column, 3/4 in. -30 shaft. 5.548-0 ..... **\$86.00 EA** ⚠

**FR1746DDPL** ..... ALL  
1 in. DD column, 3/4 in. -30 shaft (polished). 5.548-0 ..... **\$109.00 EA** ⚠

**FR1754DD** ..... ALL  
1 in. DD column, 1 in. DD shaft. 5.548-0 ..... **\$86.00 EA** ⚠

**FR1754DDPL** ..... ALL  
1 in. DD column, 1 in. DD shaft (polished). 5.548-0 ..... **\$109.00 EA** ⚠

**Steering Wheels (Flaming River) -Waterfall**

Waterfall Steering Wheel. Classic Styling with modern accents. 13.8" dia., premium Italian leather grips. Requires use of one of the adapters listed below.

**FR20150** ..... ALL  
"Waterfall". Classic Styling, modern accents. 13.8 in. dia., premium Italian black leather grip. Requires use of adapter

#FR20150HGAD. 6.513-0.15 ..... **\$460.29 EA** ⚠

**FR20150LG** ..... ALL  
"Waterfall". Classic Styling, modern accents. 13.8 in. dia., premium Italian Light Grey leather grip. Requires use of adapter

#FR20150HGAD. 6.513-0.15 ..... **\$460.29 EA** ⚠

**Steering Wheels (Flaming River) -Banjo**

**FR20128BJBK** ... ALL  
Banjo, Black. 9-bolt, elegant 5 strand banjo. 15" diameter. Adapter & horn button included. 6.513-0

..... **\$526.80 EA** ⚠

**FR20128BJLG** ... ALL  
Banjo, Grey. 9-bolt, elegant 5 strand banjo. 15" diameter. Adapter & horn button included. 6.513-0

..... **\$526.80 EA** ⚠

**Steering Wheels (Flaming River) -Cascade**

Radiused Billet Spokes. A new classic style! Modular pattern leather grip is highlighted with a modern flowing spoke design in billet aluminum. Premium Italian Leather - Black, Slate Grey or Light Grey. 13.8" dia., 6 bolt mount.

**FR20160** ..... ALL  
Cascade, Black. 13.8" 6 Bolt Mount 6.513-0.15 ..... **\$463.29 EA** ⚠

**FR20160DG** ..... ALL  
Cascade, Slate Grey. 13.8" 6 Bolt Mount 6.513-0.15 ..... **\$463.29 EA** ⚠

**FR20160LG** ..... ALL  
Cascade, Light Grey. 13.8" 6 Bolt Mount 6.513-0.15 ..... **\$463.29 EA** ⚠

**Steering Wheels (Flaming River) -Corvette**

Nostalgic Corvette Wheel is the perfect addition to top off your new Flaming River column. 15" diameter, laser cut, stainless steel spokes, 6-bolt design. Horn button & adapter sold separately. Available in Black, Tan, Red, Light Grey & Paintable Grip.

**FR20151RE** ..... ALL  
Corvette. Red molded, paintable grip. 15" dia. 6 Bolt mount 6.513-0 ..... **\$413.00 EA** ⚠

**FR20152BK** ..... ALL  
Corvette, Black leather. 15" dia. 6 Bolt mount 6.513-0 ..... **\$413.00 EA** ⚠

**FR20152LG** ..... ALL  
Corvette, Light Grey leather. 15" dia. 6 Bolt mount 6.513-0 ..... **\$413.00 EA** ⚠

**Steering Wheels (Flaming River) -Corvette, cont.**

**FR20152RE** ..... ALL  
Corvette, Red leather. 15" dia. 6 Bolt mount 6.513-0 ..... **\$413.00 EA** ⚠

**FR20152TN** ..... ALL  
Corvette, Tan leather. 15" dia. 6 Bolt mount 6.513-0 ..... **\$413.00 EA** ⚠

**Steering Wheels (Flaming River) -Woody's III**

**FR20123** ..... ALL  
Woody's III. Mahogany/Chrome three spoke steering wheel. Diameter 13.8 inches. Comes with chrome beauty ring and horn button. 6.513-0 ..... **\$282.00 EA** ⚠

**Steering Wheel Adapters (Flaming River)**

Use to mount Flaming River steering wheels to Flaming River & GM columns.

**FR2000VTAD** ..... ALL  
Adapter to mount original Corvette steering wheels to Flaming River columns. 6.513-0

..... **\$131.19 EA** ⚠  
**FR20119BA** ..... ALL  
Bell 5/ 6-bolt pattern. Billet aluminum. 6.513-0 ..... **\$114.09 EA** ⚠

**FR20150HGAD** ... ALL  
Adapter for Flaming River Waterfall steering wheel. Classic hourglass shape fits Flaming River columns. 6.513-0

..... **\$109.00 EA** ⚠  
**FR20150HGADOE** ..... ALL  
Adapter for Flaming River Waterfall steering wheel. Classic hourglass shape fits GM columns. 6.513-0 ... **\$99.50 EA** ⚠

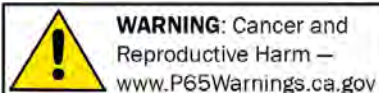

NOTE: Any chemicals will be shipped domestic ground only (Lower 48 states only). No international shipping.

# Section 190: Steering Columns, Steering Wheels, Shafts, Rebuild Kits, Steering Components & Related

## Steering Wheel Adapters (Flaming River), cont.



**FR20156SS** .....ALL  
Stainless adapter.  
Corvette "bell" style w/  
Corvette bolt pattern.  
6.513 -0.15  
..... \$139.39 EA ⚠

**FR20160AD** ..... ALL  
Fits Flaming River Cascade steering  
wheel. Classic hourglass shape fits  
Flaming River columns. 13.8" 6 Bolt  
Mount 6.513 -0 ..... \$109.00 EA ⚠

## Horn Button (Flaming River)



**FR20113LHN** ....ALL  
Fits 9-hole adapter.  
Polished, Billet  
aluminum. Includes  
o-ring. 6.513 -0.15  
..... \$102.00 EA ⚠



**FR20151HRN** ....ALL  
Horn button for Flaming  
River Corvette steering  
wheel. 6.513 -0  
..... \$98.00 EA ⚠

## Steering Wheel-Select Edition 14" (Billet Specialties)



**BIS29244** .....ALL  
Boost. 14 inch.  
6.513 -0.15  
..... \$260.00 EA ⚠



**BIS29244BLK** ...ALL  
Boost black anodized.  
14 inch. 6.513 -0.15  
..... \$300.00 EA ⚠



**BIS29263** .....ALL  
Draft. 14 inch.  
6.513 -0.15  
..... \$260.00 EA ⚠



**BIS29263BLK** ...ALL  
Draft black anodized.  
14 inch. 6.513 -0.15  
..... \$300.00 EA ⚠

## Steering Wheel-Select Edition 14" (Billet Specialties), cont.



**BIS29299** .....ALL  
Throttle. 14 inch.  
6.513 -0.15  
..... \$260.00 EA ⚠



**BIS29299BLK** ...ALL  
Throttle black anodized.  
14 inch. 6.513 -0.15  
..... \$300.00 EA ⚠



**BIS29301** .....ALL  
Impact. 14 inch.  
6.513 -0.15  
..... \$260.00 EA ⚠



**BIS29308** .....ALL  
Monaco. 14 inch.  
6.513 -0.15  
..... \$260.00 EA ⚠



**BIS29315** .....ALL  
Monaco. 14 inch.  
6.513 -0.15  
..... \$260.00 EA ⚠

## Steering Wheel -Billet Specialties Half Wrap Cover Select Edition

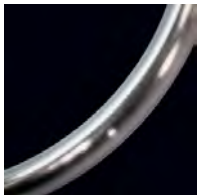

**BIS28600** .....ALL  
Blank for custom wrap  
applications. 14 inch.  
Select Edition steering  
wheels only. 6.513 -0.15  
..... \$100.00 EA ⚠

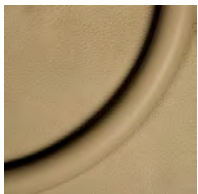

**BIS28602** .....ALL  
Tan Leather. 14 inch.  
Select Edition steering  
wheels only. 6.513 -0.15  
..... \$120.00 EA ⚠

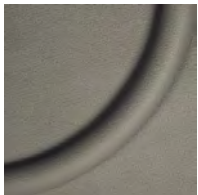

**BIS28603** .....ALL  
Light Grey Leather. 14  
inch. Select Edition  
steering wheels only.  
6.513 -0.15  
..... \$120.00 EA ⚠

## Steering Wheel -Billet Specialties Half Wrap Cover Select Edition, cont.



**BIS28605** .....ALL  
Red Leather. 14 inch.  
Select Edition steering  
wheels only. 6.513 -0.15  
..... \$120.00 EA ⚠



**BIS28608** .....ALL  
Black Leather. 14 inch.  
Select Edition steering  
wheels only. 6.513 -0.15  
..... \$120.00 EA ⚠

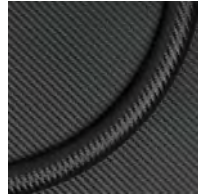

**BIS28613** .....ALL  
Simulated Carbon Fiber.  
14 inch. Select Edition  
steering wheels only.  
6.513 -0.15  
..... \$120.00 EA ⚠

## Half Wrap Steering Wheels

Steering wheels shown with Colored Wrap and Horn Buttons for display purposes.

Choose a steering wheel style, pick a colored half wrap (available in 14 & 15.5 dia.) & choose horn button & adapter on the following pages.

Choose color & style of Half-Wrap & Horn Button on following pages.



**BIS29825** .....ALL  
Eagle. 14 inch.  
6.513 -0.15  
..... \$230.00 EA ⚠



**BIS30017** .....ALL  
Fury. 14 inch. 6.513 -0.15  
..... \$340.00 EA ⚠



**BIS30092** .....ALL  
Stiletto. 14inch. -0.15  
..... \$340.00 EA ⚠



**BIS30096** .....ALL  
Rail. 14inch. -0.15  
..... \$340.00 EA ⚠



# Section 190: Steering Columns, Steering Wheels, Shafts, Rebuild Kits, Steering Components & Related

## Half Wrap Steering Wheels, cont.



**BIS30445** .....ALL  
Outlaw. 14 inch.  
6.513 -0.15  
..... \$230.00 EA ⚠



**BIS30725** .....ALL  
Classic. 14 inch.  
6.513 -0.15  
..... \$230.19 EA ⚠



**BIS30735** .....ALL  
Rival. 14 inch.  
6.513 -0.15  
..... \$265.19 EA ⚠



**BIS30765** .....ALL  
Chicayne. 14 inch.  
6.513 -0.15  
..... \$230.00 EA ⚠



**BIS30925** .....ALL  
Banjo. 14 inch.  
6.513 -0.15  
..... \$265.25 EA ⚠



**BIS34175** .....ALL  
Fast Lane. 15.5 inch.  
6.513 -0.15  
..... \$255.19 EA ⚠



**BIS34425** .....ALL  
Vintec. 15.5 inch.  
6.513 -0.15  
..... \$255.00 EA ⚠



**BIS34445** .....ALL  
Outlaw. 15.5 inch.  
6.513 -0.15  
..... \$255.00 EA ⚠

## Half Wrap Steering Wheels, cont.



**BIS34725** .....ALL  
Classic. 15.5 inch.  
6.513 -0.15  
..... \$255.19 EA ⚠



**BIS34765** .....ALL  
Chicayne. 15.5 inch.  
6.513 -0.15  
..... \$255.00 EA ⚠



**BIS34925** .....ALL  
Banjo. 15.5 inch.  
6.513 -0.15  
..... \$290.25 EA ⚠

## Steering Wheel -Billet Specialties Half Wrap Cover

Choose a Half-Wrap to go with your Billet Wheel. All are available for 14" or 15.5" wheels. Choose the Blank for using your own material to match your interior. Leather half-wraps are genuine hand cut, top grain leather of superior quality. Steering wheel rings are fastened to the wheel by hidden bolts, recessed on the back of the wheel.

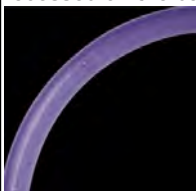

**BIS29000** .....ALL  
Blank for custom wrap applications. 14 inch.  
6.513 -0.15  
..... \$34.39 EA ⚠

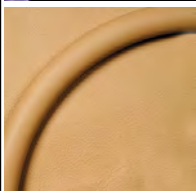

**BIS29002** .....ALL  
Tan Leather. 14 inch.  
6.513 -0.15  
..... \$43.69 EA ⚠

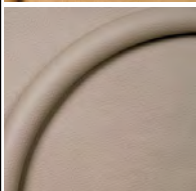

**BIS29003** .....ALL  
Light Grey Leather. 14 inch.  
6.513 -0.15  
..... \$47.00 EA ⚠

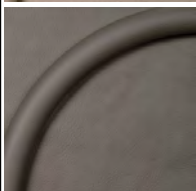

**BIS29004** .....ALL  
Dark Grey Leather. 14 inch.  
6.513 -0.15  
..... \$47.00 EA ⚠

## Steering Wheel -Billet Specialties Half Wrap Cover, cont.

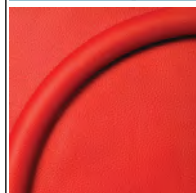

**BIS29005** .....ALL  
Red Leather. 14 inch.  
6.513 -0.15  
..... \$47.00 EA ⚠

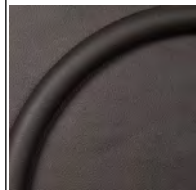

**BIS29008** .....ALL  
Black Leather. 14 inch.  
6.513 -0.15  
..... \$43.69 EA ⚠

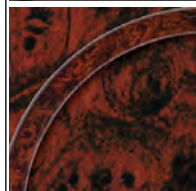

**BIS29012** .....ALL  
Simulated Burl Wood. 14 inch.  
6.513 -0.15  
..... \$57.75 EA ⚠

**BIS33000** ..... ALL  
Blank for custom wrap applications. 15.5 inch.  
6.513 -0.15  
..... \$39.09 EA ⚠



**BIS33002** .....ALL  
Tan Leather. 15.5 inch.  
6.513 -0.15  
..... \$48.39 EA ⚠



**BIS33003** .....ALL  
Light Grey Leather. 15.5 inch.  
6.513 -0.15  
..... \$52.00 EA ⚠



**BIS33005** .....ALL  
Red Leather. 15.5 inch.  
6.513 -0.15  
..... \$52.00 EA ⚠

**BIS33008** ..... ALL  
Black Leather. 15.5 inch. 6.513 -0.15  
..... \$48.39 EA ⚠

**BIS33012** ..... ALL  
Simulated Burl Wood. 15.5 inch.  
6.513 -0.15  
..... \$62.50 EA ⚠

## Billet Horn Button (Billet Specialties)



**BIS32120** .....ALL  
Standard size. Plain.  
6.513 -0.15  
..... \$41.00 EA ⚠



**WARNING:** Cancer and Reproductive Harm — [www.P65Warnings.ca.gov](http://www.P65Warnings.ca.gov)

NOTE: Any chemicals will be shipped domestic ground only (Lower 48 states only). No international shipping.

(800) 952-1752 • [www.streetrodhq.com](http://www.streetrodhq.com)

**Billet Horn Button (Billet Specialties), cont.**



**BIS32125 . . . . .ALL**  
Large size. Plain.  
6.513 -0.15  
..... \$48.00 EA ⚠



**BIS32320 . . . . .ALL**  
Standard size. Bowtie.  
6.513 -0  
..... \$44.69 EA ⚠



**BIS32325 . . . . .ALL**  
Large size. Bowtie.  
6.513 -0.15  
..... \$56.00 EA ⚠



**BIS32625 . . . . .ALL**  
Large size. Billet Logo.  
6.513 -0.15  
..... \$48.00 EA ⚠



**BIS32710 . . . . .ALL**  
Pro-Style Riveted with  
Polished Logo 6.513 -0.15  
..... \$75.00 EA ⚠



**BIS32715 . . . . .ALL**  
Pro-Style Riveted with  
Black Logo 6.513 -0.15  
..... \$75.00 EA ⚠



**BIS32719 . . . . .ALL**  
Pro-Style Riveted Black  
Anodized with Black  
Logo 6.513 -0.15  
..... \$75.00 EA ⚠



**BIS32720 . . . . .ALL**  
Pro-Style Smooth with  
Polished Logo 6.513 -0.15  
..... \$75.00 EA ⚠

**Billet Horn Button (Billet Specialties), cont.**



**BIS32725 . . . . .ALL**  
Pro-Style Smooth with  
Black Logo 6.513 -0.15  
..... \$75.00 EA ⚠



**BIS32729 . . . . .ALL**  
Pro-Style Smooth Black  
Anodized with Black  
Logo 6.513 -0.15  
..... \$75.00 EA ⚠



**BIS32925 . . . . .ALL**  
Large size. Banjo style.  
6.513 -0  
..... \$44.75 EA ⚠

**Steering Wheel Adapters (Billet Specialties)**



**BIS31120 . . . . .ALL**  
Fits 1967-94 GM  
Columns. -0.15  
..... \$47.99 EA ⚠



**BIS31120BLK . . . . .ALL**  
Fits 1967-94 GM  
Columns. Black  
Anodized. -0.15  
..... \$51.00 EA ⚠



**BIS31126 . . . . .ALL**  
Fits 1996 to 2004 GM,  
non-Airbag columns. -0  
..... \$53.99 EA ⚠



**BIS31322 . . . . .ALL**  
Fits 1949 to 1966  
GM non tilt columns.  
Includes cancel cam for  
1955-56 columns. -0.15  
..... \$56.00 EA ⚠



**BIS31322BLK . . . . .ALL**  
Fits 1949 to 1966  
GM non tilt columns.  
Includes cancel cam for  
1955-56 columns.  
Black Anodized -0.15  
..... \$61.00 EA ⚠

**Steering Wheel Adapters (Billet Specialties), cont.**



**BIS31323 . . . . .ALL**  
Telescoping 3"  
adapter. -0.15  
..... \$72.79 EA ⚠



**BIS31324 . . . . .ALL**  
Telescoping 2"  
adapter. -0.15  
..... \$73.00 EA ⚠



**BISLC22404 . . . . .ALL**  
Fits 64-67 Mustang  
w 3-5/8" dia.  
columns. -0.15  
..... \$76.00 EA ⚠

**16 Inch Steering Wheels**



**CRESTLINERGM . . . . .ALL**  
16" Paintable Crestliner  
Wheel For Gm Spline  
Column -0  
..... \$800.00 EA ⚠



**DFOURTYFD . . . . .ALL**  
16" 40 Ford taper and  
key column -0.15  
..... \$299.29 EA ⚠



**DFOURTYFDGM . . . . .ALL**  
16" 40 Ford Steering  
wheel For Gm Spline  
Column -0  
..... \$327.29 EA ⚠

**15 Inch Steering Wheels**



**RP20001 . . . . .55-56**  
55-56 Chevrolet,  
replaces stock 18" -0.15  
..... \$379.00 EA ⚠



**RP20002 . . . . .57**  
1957 Chevrolet,  
replaces stock 18" -0.15  
..... \$379.00 EA ⚠

**15 Inch Steering Wheels, cont.**



**RP20003** ..... 57  
58-60 Chevrolet, replaces stock 18" -0.15

..... **\$378.49 EA** ⚠



**RP20005** ..... 57  
56-57 T-Bird, replaces stock 18" -0.15

..... **\$378.49 EA** ⚠

**Cruise Control Kits**

Cruise control for your ride. Complete kits for Cable Driven or Electronic Speedometers. Choose you handle style (included in kit price) from next column.



**CRS-2000**.....**.ALL**

For cable driven speedos. Choose control handle. -0.15 ..... **\$295.29 EA** ⚠



**CRS-2100**.....**.ALL**

For cable driven speedos. Choose control handle. -0.15 ..... **\$295.00 EA** ⚠



**CRS-3000**.....**.ALL**

For electronic speedos. Choose control handle. -0.15 ..... **\$255.00 EA** ⚠

**Cruise Control Handles**

Cruise control handles are available separately or FREE with Cruise Control Kit (previous column). Please include the handle part number when ordering Cruise Control Kits.



**HNC-1**.....**.ALL**

Brushed aluminum control cover. -0 ..... **\$35.00 EA** ⚠



**HND-2**.....**.ALL**

-0.15 ..... **\$53.00 EA** ⚠



**HND-3**.....**.ALL**

-0.15 ..... **\$42.09 EA** ⚠



**WARNING: Cancer and Reproductive Harm —**  
www.P65Warnings.ca.gov

NOTE: Any chemicals will be shipped domestic ground only (Lower 48 states only). No international shipping.

**C5 Corvette Suspension Conversion For Chevy Cars**

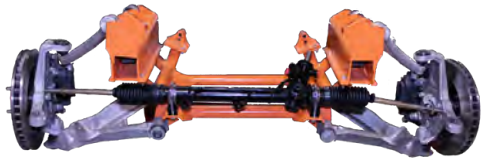

**C5 CONV** .....39-48  
 Don't have a donor C5 Corvette? We've put together all the components for a front C5 Conversion in a kit. Complete with factory nuts/bolts to put it together. Does not include shocks and springs. Bolt in for 1939-48 Chevrolet Cars. All new parts instead of used donor parts.

57" Track Width. Must use min. 17" wheel with 4" Back Spacing.

Rack & Pinion unit is rotatable for motor mount or header clearance.

No welding on frame. No holes to drill. Bolts right in. Could do install in an afternoon. Doesn't use 30+ year old Mustang II technology. Comes with factory GM Aluminum A-frames and steering knuckles. Tubular crossmember for strength. Motor mounts for SBC, BBC and adapters for LS-Series motors.

Note: Must weld engine mounts. -0  
 ..... **CALL** ⚠

**C5 Corvette Suspension Conversion For Chevy Cars, cont.**

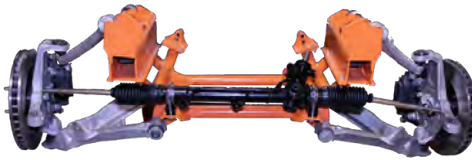

**C5 CONV** .....49-54  
 Don't have a donor C5 Corvette? We've put together all the components for a front C5 Conversion in a kit. Complete with factory nuts/bolts to put it together. Does not include shocks and springs. Bolts in easily on 1949-54 Chevrolet Cars and 1953-62 Corvette. All new parts instead of used donor parts.

57" Track Width. Must use min. 17" wheel with 4" Back Spacing.

Rack & Pinion unit is rotatable for motor mount or header clearance.

No welding on frame. No holes to drill. Bolts right in. Could do install in an afternoon. Doesn't use 30+ year old Mustang II technology. Comes with factory GM Aluminum A-frames and steering knuckles. Tubular crossmember for strength.

Note: Must weld engine mounts. -0  
 ..... **CALL** ⚠

**C5 Corvette Suspension Conversion Crossmembers & Steering Rack For Chevy Cars**



**C5CONV** .....39-48  
 C5 Corvette Suspension Conversion. Bolt on front crossmember. Fits 39-48 Chevy car & sedan delivery (exc. straight axle) using your C5 suspension components. Requires C5RACK & C5SHOCKLMF. Must weld engine mounts. -0.15 .. **\$1,025.00 EA** ⚠

**C5 Corvette Suspension Conversion Crossmembers & Steering Rack For Chevy Cars, cont.**



**TRANCROSS** .....39-48  
 Bolt on crossmember converts your stock auto or manual trans frame to accept all GM automatic transmissions, except Powerglide. Uses all original crossmember mounting holes. Chevy car 39-48 -0.15  
 ..... **\$225.00 EA** ⚠



**C5RACK** .....39-54  
 Power steering rack required for C5 CONV IFS conversion. -0.15 **\$675.00 EA** ⚠



**C5CONV** .....49-54  
 C5 Corvette Suspension Conversion. Bolt on front crossmember.

Fits 49-54 car & sedan delivery, also 1953-62 Corvette using your C5 suspension components. Requires C5RACK & C5SHOCKLMF. Must weld engine mounts. -0.15 **\$978.00 EA** ⚠

**C5 Corvette Suspension Conversion Components Kit For Chevy Cars**

**C5COMP** .....39-54  
 Don't have a donor C5 Corvette? We've put together all the components for a front C5 Conversion in a kit. Complete with factory nuts/bolts to put it together. Does not include crossmember, steering rack, shocks, springs. All new parts instead of used donor parts.

57" Track Width. Must use min. 17" wheel with 4" Back Spacing. -0.15  
 ..... **\$3,000.00 EA** ⚠

**C5 Corvette Suspension Conversion Components For Chevy Cars**



**10332529** ....39-54  
 C5 Knuckle Right Front  
 6.020 -0.15  
 ..... **\$363.29 EA** ⚠

**C5 Corvette Suspension Conversion Components For Chevy Cars, cont.**



**10326693** .....ALL  
C5 Front Left Lower Control Arm With Bushings And Ball

Joints. New -0.15



**10326694** .....ALL  
C5 Front Right Lower Control Arm With Bushings And Ball

Joints. New -0.15



**10332530** .....ALL  
C5 Knuckle Left Front

6.020 -0.15



**10356436** .....ALL  
C5 Front Left Upper Control Arm With Bushings New

New -0.15

**10356438** .....ALL

C5 Front Right Upper Control Arm With Bushings New

..... \$175.59 EA ⚠



**10445856** .....ALL  
Right Front Brake Rotor Assembly New For C5

-0.15

..... \$81.50 EA ⚠

**10445857** .....ALL

Front Left Brake Rotor Assembly New For C5

..... \$81.50 EA ⚠



**12530682** .....ALL  
Front Right Caliper W/ Mounting Bracket New For C5

-0.15

..... \$87.25 EA ⚠

**12530683** .....ALL

Front Left Caliper W/ Mounting Bracket New For C5

..... \$87.09 EA ⚠



**19207042** .....ALL  
Front Brake Pads - OE Ceramic

-0.15

..... \$69.75 EA ⚠



**513139** .....ALL  
C5 Corvette Front Hub Assembly, Left or Right

-0.15

..... \$139.00 EA ⚠



**88910455** .....ALL  
Tie Rod Ends For C5 Conv. Left or Right.

6.233 -0

..... \$51.69 EA ⚠

**C5 Corvette Suspension Conversion Components For Chevy Cars, cont.**



**C5SHOCKLMF** ...ALL  
Shock mounts on lower control arm , for C5 suspension

7.395 -0.15

..... \$200.00 PR ⚠



**LSX MOUNT** .....ALL  
Use to mount LS1, LS6 or Vortec (4.8L, 5.3L or 6.0L) into cars setup for small block Chevy.

0.027 -0



**LSX MOUNT1** .....ALL  
Use to mount LS1, LS6 or Vortec (4.8L, 5.3L or 6.0L) into cars setup for small block Chevy. Sets engine back 1" from standard SBC

location. 0.027 -0.15

..... \$88.50 PR ⚠

**IFS - Heidts Mustang II Kit - Weld In - Chevy Car Or Truck**

Mustang II Suspension kits come complete with crossmember, paintable tubular upper and lower full A-frame style control arms, 11 1/2" five lug rotors, bearings and seals, springs, shocks, stock spindles, GM calipers with brackets and pads, manual rack and pinion with tie rod ends and bushings, rubber spring cushions, spindle nuts w/washers, and all mounting hardware. Power rack upgrade available.

Specify Vehicle:

- 37-39 Chevy Car
- 40-48 Chevy Car
- 49-54 Chevy Car
- 37-39 Chevy Truck
- 40-46 Chevy Truck
- 47-54 Chevy Truck



**HEIDTIFS01** .....37-54  
Independent Front Suspension Kit. Heidt's weld in. Tubular A-arms with crossmember.

6.008 -0 ..... \$2,090.75 KIT ⚠

**HEIDTIFS02** .....37-54  
Independent front suspension kit Heidt's weld in. Tubular A-arms, without crossmember.

6.008 -0 ..... \$1,800.00 KIT ⚠

**IFS Suspension Kit**



**CX307EK** .....47-54  
Deluxe Independent front suspension. 1947-1954 Chevy Pick up complete Mustang II IFS kit. Included are a 3 piece weld in crossmember with upper spring hats already notched for your frame once you install the boxing plates, tubular upper and lower control arms, 11 brakes with GM metric calipers, stock or 2 drop spindles, manual rack and pinion, and standard shocks and springs. Everything you need to give you independent suspension.

6.008 -0 ..... \$1,899.00 EA ⚠



**CX307EKRH** .....47-54  
Deluxe Independent front suspension. Right Hand Drive. 1947-1954 Chevy Pick up complete Mustang II IFS kit. Included are a 3 piece weld in crossmember with upper spring hats already notched for your frame once you install the boxing plates, tubular upper and lower control arms, 11 brakes with GM metric calipers, stock or 2 drop spindles, manual rack and pinion, and standard shocks and springs. Everything you need to give you independent suspension.

6.008 -0.15 ..... \$2,599.00 EA ⚠

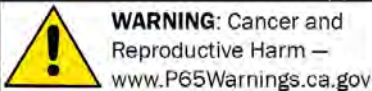

**WARNING: Cancer and Reproductive Harm** —  
www.P65Warnings.ca.gov

NOTE: Any chemicals will be shipped domestic ground only (Lower 48 states only). No international shipping.



**IFS - Heidts SUPERIDE II Kit**

The best in easy to install IFS! Smooth ride, great handling. Uses Heidts dropped spindles which allows for a front mount rack & pinion to ease motor installations. 2" lower ride height, highly steerable, built in anti-dive and NO bumpsteer. Included detailed instructions for easy installation. Note: stock spindles may be substituted to raise vehicle 2". Complete hub-to-hub kits include: Σ Main crossmember T.I.G. welded for maximum strength and great looks. Σ Exclusive one piece dropped mustang II spindles. Σ Adjustable tubular A-Arms. Σ 11 disc brake vented rotors (specify either Ford or Chevy bolt pattern). Σ Adjustable COIL-OVER shocks with chrome springs. Σ Front-mount rack & pinion steering unit. Σ Stainless steel adjusters with urethane bushings. Σ Factory ball joints and tie rod ends . . \$2,799 KIT

**BX202**..... **35-41**  
Heidts weld-in Superide II, 1935-40 Ford cars and 1935-41 Ford trucks. -0

..... **\$3,504.00 KIT** ⚠



**BX212**..... **37-39**

Heidts weld-in Superide II. 1937-39

Chevy car. 6.008 -0 .. **\$3,504.00 KIT** ⚠

**BX213**..... **40-48**

Heidts weld-in Superide II. 1940-48

Chevy car. 6.008 -0 .. **\$3,504.00 KIT** ⚠

**BX203**..... **41-48**

Heidts weld-in Superide II. 1941-48 Ford

car. -0 .. **\$3,504.00 KIT** ⚠

**BX306**..... **47-55**

Heidts weld-in Superide II. 1947-54

Chevy trucks. 6.008 -0 .. **\$3,504.00 KIT** ⚠

**BX307**..... **55-59**

Heidts weld-in Superide II. 1955-59

Chevy trucks. 6.008 -0 .. **\$3,578.00 KIT** ⚠

**IFS - Heidts Superide II Kit - Upgrades**



**BS-026** ..... **ALL**

Polished stainless steel arms w/ polished adjusters & hardware. Upgrade for Superide II IFS kit. 6.008 -0

..... **\$1,399.00 SET** ⚠

**BS-056** ..... **ALL**

Sway Bar. 6.008 -0 .. **\$197.00 EA** ⚠

**IFS - Heidts Superide II Kit - Upgrades, cont.**

**BS-056-C** ..... **ALL**

Chrome Sway bar. 6.008 -0

..... **\$489.00 EA** ⚠

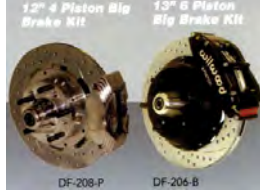

**DF-206-B** ..... **ALL**

13" 6 piston Wilwood big brake kit with crossdrilled and slotted rotors. Black anodized calipers - upgrade option to suspension kit. 6.008 -0

..... **\$1,972.00 SET** ⚠

**DF-206-P** ..... **ALL**

13" 6 piston Wilwood big brake kit. Polished calipers with slotted and crossdrilled rotors ñ upgrade option to suspension kit.

6.008 -0 .. **\$1,972.00 SET** ⚠

**DF-208-B** ..... **ALL**

12" brake upgrade with Wilwood black anodized calipers ñ upgrade option to suspension kit. 6.008 -0

..... **\$1,207.00 SET** ⚠

**DF-208-P** ..... **ALL**

12" brake upgrade with Wilwood polished calipers ñ upgrade option to suspension kit. 6.008 -0

..... **\$1,207.00 SET** ⚠



**MP-017-SS** ..... **ALL**

Polished stainless steel tie rod ends ñ upgrade option to suspension kit. 6.008 -0

..... **\$67.00 EA** ⚠



**MP-018-C** ..... **ALL**

Manual rack and pinion. Chrome dipped ñ upgrade option to suspension kit. 6.008 -0

..... **\$354.00 EA** ⚠

**IFS - Heidts Mustang II Kit - Upgrades**

**DF-202** ..... **ALL**

11" brake upgrade with polished Wilwood billet 4 piston calipers ñ upgrade option to suspension kit. 6.008 -0

..... **\$376.00 SET** ⚠

**IFS - Heidts Mustang II Kit - Upgrades, cont.**



**DF-206-B** ..... **ALL**

13" 6 piston Wilwood big brake kit with crossdrilled and slotted rotors. Black anodized calipers - upgrade option to suspension kit. 6.008 -0

..... **\$1,972.00 SET** ⚠

**DF-206-P** ..... **ALL**

13" 6 piston Wilwood big brake kit. Polished calipers with slotted and crossdrilled rotors ñ upgrade option to suspension kit.

6.008 -0 .. **\$1,972.00 SET** ⚠

**DF-208-B** ..... **ALL**

12" brake upgrade with Wilwood black anodized calipers ñ upgrade option to suspension kit. 6.008 -0

..... **\$1,207.00 SET** ⚠

**DF-208-P** ..... **ALL**

12" brake upgrade with Wilwood polished calipers ñ upgrade option to suspension kit. 6.008 -0

..... **\$1,207.00 SET** ⚠



**MP-017-SS** ..... **ALL**

Polished stainless steel tie rod ends ñ upgrade option to suspension kit. 6.008 -0

..... **\$67.00 EA** ⚠



**MP-018-C** ..... **ALL**

Manual rack and pinion. Chrome dipped ñ upgrade option to suspension kit. 6.008 -0

..... **\$354.00 EA** ⚠



**MP-050-P** ..... **ALL**

QA1 aluminum coil-over shocks, polished with chrome springs ñ upgrade option to suspension kit. 6.008 -0

..... **\$680.00 PR** ⚠



**IFS - Heidts Mustang II Kit - Upgrades, cont.**

**SP-101U** ..... ALL  
 2" DROPPED STEEL SPINDLES -  
 UPGRADE OPTION TO SUSPENSION KIT.  
 6.008 -0 ..... **\$214.00 PR** ⚠



**SS-A-ARMS** ..... ALL  
 Polished stainless steel upper and lower  
 A-arms - upgrade option to suspension kit  
 (deluxe kit only). 6.008 -0  
 ..... **\$1,096.00 PR** ⚠

**Heidts IFS Components - Tubular Coil-Over Lower Arms**

Lower Tubular arms designed to accept any  
 standard aftermarket coil-over shock (see  
 available Aldan coil-overs in section 205).

**CA-102-M** ..... ALL  
 Control Arms, Narrow Tubular Lower For  
 Coil-Overs - Plain 6.168 -0.15  
 ..... **\$383.00 PR** ⚠



**CA-102-SS-M** ..... ALL  
 Control Arms, Narrow Tubular Lower For  
 Coil-Overs - Polished Stainless 6.168 -0.15  
 ..... **\$794.00 PR** ⚠

**CA-103-M-S** ..... ALL  
 A-Arms, Tubular Full Width Lower For  
 Coil-Overs - Plain With Sway Bar Mount  
 6.168 -0.15 ..... **\$545.00 PR** ⚠

**CA-103-SS-M-S** ..... ALL  
 A-Arms, Tubular Full Width Lower For  
 Coil-Overs - Polished Stainless With Sway  
 Bar Mount 6.168 -0.15 ... **\$1,435.00 PR**  
 ⚠

**Heidts IFS Components - Tubular Lower Control Arms**

Direct replacement for stock lower A-Arms.  
 Provides more clearance for stock sheetmetal.  
 Heli-arc welded for max strength &  
 appearance. Fits Heidts and most other IFS  
 kits. Come fully assembled, ready to install w/  
 ball joints, bushings & cross shafts.

**Heidts IFS Components - Tubular Lower Control Arms, cont.**



**CA-102-SS** ..... ALL  
 Control Arms, Narrow Tubular Lower -  
 Polished Stainless 6.168 -0.15  
 ..... **\$1,053.00 PR** ⚠

**Heidts Sway Bars**

**SB-004** ..... 40-48  
 Sway Bar. Front. Heidts Mustang II  
 Suspension kit. Does not include lower  
 mounts.  
 40-48 Chevrolet Car 6.008 -0  
 ..... **\$229.00 EA** ⚠

**SB-007** ..... 47-52  
 Control body roll. Made from heat treated  
 steel to make your vehicle more stable.  
 Bracket kits sold separately. 6.008 -0.4  
 ..... **\$229.00 EA** ⚠

**SB-005** ..... 49-54  
 SWAY BAR. FRONT - HEIDTS MUSTANG II  
 SUSPENSION KIT - 49-54 CHEV CAR.  
 6.008 -0.4 ..... **\$229.00 EA** ⚠

**Heidts Sway Bar Bracket Kit**



**SB-012-SS** ..... ALL  
 Sway bar bracket kit. 6.008 -0.15  
 ..... **\$103.00 SET** ⚠

**IFS - Chassis Engineering Kit**

For Chassis Engineering IFS kit upgrades or  
 individual components call or visit our website.

**Crossmember (Bolt On) - Chevy Car**

Bolt-on crossmember kits provide superior  
 strength. Upper spring pods give 2-1/2"  
 adjustability for Mustang II/ Pinto front end.  
 Center support rods add strength & durability  
 to lower strut rod mount. Eliminates bump  
 steer.



**IF-3739CP** ..... 37-39  
 6.008 -0 ..... **\$755.00 EA** ⚠

**Crossmember (Bolt On) - Chevy Car, cont.**

**IF-4040CP** ..... 40  
 6.008 -0 ..... **\$755.00 EA** ⚠  
**IF-4148CP** ..... 41-48  
 6.008 -0 ..... **\$755.00 EA** ⚠



**CP-1109G** ..... 49-54  
 Option to have mounts welded to  
 crossmember IF-4954CP. Comes ready to  
 mount your '58 & up small block (bolt-on  
 mounts available separately also). Add to  
 IF-4954CP price. 0.029 -0  
 ..... **\$108.00 SET** ⚠



Image shown with optional welded-on  
 motor mounts—part #CP-1109G.

**IF-4954CP** ..... 49-54  
 Because of clearances this kit uses a one  
 piece wide lower A-frame instead of the  
 original Pinto/Mustang strut rod. No bump  
 steer or other unpleasant surprises. Upper  
 coil spring pods are adjustable giving  
 about 1/2" adjustment at the wheel. The  
 best method available to adjust for correct  
 ride height geometry. For use w/ manual  
 rack. 6.008 -0 ..... **\$755.00 EA** ⚠

**Crossmember (Bolt On) - Chevy Truck**



**IF-4854CPT** ..... 47-54  
 Bolt-in crossmember kit (widened 2" w/  
 adjusted pivot points & rack extensions).  
 6.008 -0 ..... **\$755.00 EA** ⚠



**WARNING: Cancer and Reproductive Harm** —  
[www.P65Warnings.ca.gov](http://www.P65Warnings.ca.gov)

NOTE: Any chemicals will be shipped domestic ground only (Lower 48 states only). No international shipping.

**Crossmember (Weld on) - Chevy Cars**



**CX102E**.....**37-39**  
CROSSMEMBER. MUSTANG II, HEIDT'S  
WELD IN, 37-39 CHEV CAR. 6.008 -0  
..... **\$470.00 EA** ⚠



**CX103E**.....**40-48**  
Heidt's Mustang II weld in crossmember.  
1940-48 Chevy Cars. 6.008 -0  
..... **\$448.00 EA** ⚠

**CX104E**.....**49-54**  
CROSSMEMBER. MUSTANG II, HEIDT'S  
WELD IN, 49-54 CHEV CAR. 6.008 -0.15  
..... **\$470.00 EA** ⚠

**Front Suspension Mounting Kit - Chevy Trucks**



**AR-2340**.....**37-54**  
Pacer IFS. Installation is bolt-on after  
these brackets are welded to the  
crossmember. Pacer front crossmember  
bolts-on & contains all needed heavy duty  
suspension parts (original A-arms, springs,  
tie rods, steering, shocks, etc) in a single  
unit. (requires donor front end from AMC  
Pacer). 6.008 -0 ..... **\$111.00 SET** ⚠

**Crossmember (Weld On) - Chevy Trucks**



**CX305E**.....**37-39**  
Heidt's Mustang II weld in crossmember.  
6.008 -0 ..... **\$448.00 EA** ⚠  
**CX306E**.....**40-46**  
Heidt's Mustang II weld in crossmember.  
6.008 -0 ..... **\$448.00 EA** ⚠

**Crossmember (Weld On) - Chevy Trucks, cont.**

**CX307E**.....**47-54**  
Heidt's Mustang II weld in crossmember.  
For single lower pivot. 6.008 -0  
..... **\$448.00 EA** ⚠

**C4 Corvette IFS Install Kit**

Make your 47-54 Chevy truck handle and stop  
like a vette. These kits install donor C4 (1984-  
96) Corvette front suspension and steering.  
For complete details see Section 205.



**SUSCORF1**.....**36-54**  
1/2 ton only 6.008 -0 ..... **\$893.75 SET** ⚠  
**SUSCORF2**.....**36-54**  
1/2 ton only 6.008 -0 ..... **\$945.00 SET** ⚠  
**SUSCORFBUSH**..... **ALL**  
front urethane bushing kit 6.008 -0.15  
..... **\$150.00 SET** ⚠



**SUSCORFRBUSH**.. **ALL**  
Front and rear urethane  
bushing kit 6.008 -0.15  
..... **\$300.00 SET** ⚠

**Crossmember (Bolt On) - Ford Car**



**IF-4248FP**.....**42-48**  
Bolt-On Pinto Mustang II Crossmember kit  
for 1942-1948 Ford Car -0.15  
..... **\$831.00 SET** ⚠

**Crossmember (Bolt On) - Ford Truck**

**IF-4852FPT**....**48-52**  
Bolt-On Pinto Mustang  
II Crossmember kit for  
1948-1952 Ford Pickup Truck -0.15  
..... **\$831.00 SET** ⚠

**Crossmember (Weld On) - Ford Trucks**



**PX102E**.....**35-41**  
Mustang II, Heidt's weld in, 35-40 Ford car  
and 35-41 Ford truck. -0  
..... **\$448.00 EA** ⚠

**PX104E**.....**48-52**  
Mustang II, Heidt's weld in, 48-52 Ford  
F1. -0 ..... **\$448.00 EA** ⚠  
**PX105E**.....**53-56**  
Mustang II, Heidt's weld in, 53-56 Ford  
F-100. -0 ..... **\$448.00 EA** ⚠

**Crossmember (Weld On) - Ford Cars**



**PX102E**.....**35-41**  
Mustang II, Heidt's weld in, 35-40 Ford car  
and 35-41 Ford truck. -0 ..... **\$448.00 EA**  
⚠

**Crossmember (Heidts Weld On) - Ford Cars**

**PX103E**.....**41-48**  
Mustang II, Heidt's weld  
in, 41-48 Ford car. -0  
..... **\$448.00 EA** ⚠

**Crossmember (Heidts Weld On) - Universal**

Universal applications for vehicles with 56"  
or 60" track widths (frame rail dimensions  
measured outside to outside). For use w/  
Mustang II frontends.



**KX101**.....**ALL**  
Deluxe. 56" tread width for 24"-30" rail  
widths. -0 ..... **\$448.00 SET** ⚠  
**KX101E**..... **ALL**  
Standard. 56" tread width for 24"-30"  
rail widths. -0 ..... **\$448.00 SET** ⚠  
**KX102**..... **ALL**  
Standard. 60" tread width for 27.5"-33.5"  
rail widths. -0 ..... **\$499.00 SET** ⚠

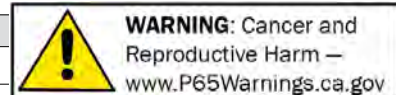

**Crossmember (Heidts Weld On) - Universal, cont.**

**KX102E** ..... ALL  
Deluxe. 60" tread width for 27.5"-33.5" rail widths. -0 ..... **\$448.00 SET** ⚠

**Dropped Uprights & Steering Arms - Chevy**



**CDU3948** .....39-48  
1939-48 Chevy 2 1/2" dropped uprights for the original IFS, dropped steering arms CSA3948 required. Will accept original drum or aftermarket disc brakes. -0

..... **\$450.00 L&R** ⚠



**CSA3948** .....39-48  
1939-48 Chevy dropped steering arms for the original IFS required with the dropped uprights -0

..... **\$215.00 L&R** ⚠



**CDU4954** .....49-54  
1949-54 Chevy dropped uprights for the original IFS, 2 1/2" drop on '49-'52, 2" drop on '53-'54, dropped steering arms CSA4954

required. Will accept stock drum brakes or aftermarket disc brakes. -0

..... **\$450.00 L&R** ⚠



**CSA4954** .....49-54  
1949-54 Chevy dropped steering arms for the original IFS required with the dropped uprights -0

..... **\$215.00 L&R** ⚠



**CORV5362** .....53-62  
1953-62 Corvette 2" dropped uprights for the original IFS, dropped steering arms CORVSA5362 required. Will accept stock drum

brakes or aftermarket disc brakes. -0

..... **\$450.00 L&R** ⚠



**CORVSA5362** .....53-62  
1953-62 Corvette dropped steering arms for the original IFS required with the dropped uprights -0

..... **\$215.00 L&R** ⚠

**Dropped Uprights & Steering Arms - Ford, cont.**

**FDU4953** .....49-53  
1949-53 Ford 2 1/2" dropped uprights for the original IFS, dropped steering arms FSA4953

required. Includes fitted kingpin and bushing set. Will accept original drum or aftermarket disc brakes. -0

..... **\$550.00 L&R** ⚠

**FSA4953** .....49-53  
1949-53 Ford 2 1/2" dropped steering arms for the original IFS required with the dropped uprights

-0

..... **\$215.00 L&R** ⚠

**FDS5768** .....57-68  
1957-68 3" dropped spindle for all Full size Ford and Mercury -0

..... **\$650.00 L&R** ⚠

**Dropped Uprights & Steering Arms - Buick**

**BDU40S3741** .....37-41  
1937-48 Buick 40 series 2 1/2" dropped upright for the original kingpin IFS, accepts stock drum or aftermarket disc brakes, requires steering arms to be heated and bent down a matching 2 1/2" -0

..... **\$450.00 L&R** ⚠

**BDU60S3741** .....37-41  
1937-41 Buick 60 series 2 1/2" dropped upright for the original kingpin IFS, accepts stock drum or aftermarket disc brakes, requires steering arms to be heated and bent down a matching 2 1/2" -0

..... **\$450.00 L&R** ⚠

**BDU4050S4253** .....42-53  
1942-53 Buick 40 and 50 series 2 1/2" dropped upright for the original kingpin IFS, accepts stock drum or aftermarket disc brakes, requires steering arms to be heated and bent down a matching 2 1/2" -0

..... **\$450.00 L&R** ⚠

**BDU6070S4253** .....42-53  
1942-53 Buick 60 and 70 series 2 1/2" dropped upright for the original kingpin IFS, accepts stock drum or aftermarket disc brakes, requires steering arms to be heated and bent down a matching 2 1/2" -0

..... **\$450.00 L&R** ⚠

**Dropped Uprights & Steering Arms - Buick, cont.**

**BDU5456** .....54-56  
1954-56 Buick all series 2 1/2" dropped upright for the original kingpin IFS, accepts stock drum or aftermarket disc brakes, requires steering arms to be heated and bent down a matching 2 1/2" need to measure kingpin angle this type has line thru the kingpin and the upper and lower trunnions converge on top -0

..... **\$450.00 L&R** ⚠

**BDURED5456** .....54-56  
1954-56 Buick all series 2 1/2" dropped upright for the original kingpin IFS, accepts stock drum or aftermarket disc brakes, requires steering arms to be heated and bent down a matching 2 1/2" need to measure kingpin angle this type has line thru the kingpin and the upper and lower trunnions converge on bottom. -0

..... **\$450.00 L&R** ⚠

**Dropped Uprights & Steering Arms - Cadillac**

**CADLASDU3947** .....39-47  
1939-47 Cadillac and LaSalle ALL series 2 1/2" dropped upright for the original kingpin IFS, accepts stock drum or aftermarket disc brakes, requires steering arms to be heated and bent down a matching 2 1/2" -0

..... **\$450.00 L&R** ⚠

**Dropped Uprights & Steering Arms - Mercury & Lincoln**

**LINCDU4951** .....49-51  
1949-51 Mercury and Lincoln 2 1/2" dropped uprights for the original IFS, dropped steering arms LINCSA4951 required. Includes fitted kingpin and bushing set. Will accept original drum or aftermarket disc brakes. -0

..... **\$575.00 L&R** ⚠

**LINCSA4951** .....49-51  
1949-51 Mercury and Lincoln 2 1/2" dropped steering arms for the original IFS required with the dropped uprights -0

..... **\$215.00 L&R** ⚠

**MERCDU5253** .....52-53  
1952-53 Mercury, 2 1/2" dropped uprights for the original IFS, dropped steering arms MERCSA5253 required. Includes fitted kingpin and bushing set. Will accept original drum or aftermarket disc brakes. -0

..... **\$550.00 L&R** ⚠

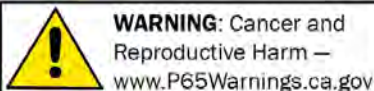

NOTE: Any chemicals will be shipped domestic ground only (Lower 48 states only). No international shipping.

**Dropped Uprights & Steering Arms - Mercury & Lincoln, cont.**

**MERCSA5253** .....52-53  
1949-53 Ford and 52-53 Mercury 2 1/2" dropped steering arms for the original IFS required with the dropped uprights -0  
..... **\$215.00 L&R** ⚠

**Dropped Uprights & Steering Arms - Oldsmobile**

**OPU4954** .....49-54  
1949-54 Olds all series, 2 1/2" dropped uprights for original IFS, accepts either stock drum brakes or aftermarket disc brakes, original steering arms must be heated and bent down a matching 2 1/2" -0  
..... **\$450.00 L&R** ⚠

**OPU5556** .....55-56  
1955-56 Olds all series, 2 1/2" dropped uprights, fits original IFS, accepts either stock drum brakes or aftermarket disc brakes, original steering arms must be heated and bent down a matching 2 1/2" -0  
..... **\$450.00 L&R** ⚠

**Dropped Uprights & Steering Arms - Pontiac**

**PDU3948** .....39-48  
1939-48 Pontiac all series, 2 1/2" dropped uprights for original IFS, accepts either stock drum brakes or aftermarket disc brakes, original steering arms must be heated and bent down a matching 2 1/2" -0  
..... **\$450.00 L&R** ⚠

**PDU4952** .....49-52  
1949-52 Pontiac all series 2 1/2" dropped Uprights for original IFS, accepts either stock drum brakes or aftermarket disc brakes, original steering arms must be heated and bent down a matching 2 1/2" -0  
..... **\$450.00 L&R** ⚠

**PDU5354** .....53-54  
1953-54 Pontiac all series 2 1/2" dropped Uprights for original IFS, accepts either stock drum brakes or aftermarket disc brakes, original steering arms must be heated and bent down a matching 2 1/2" -0  
..... **\$450.00 L&R** ⚠

**Tubular Control Arms - Ford**



**FTA5764** .....57-64  
1957-64 Ford tubular control arms Tig welded 1 x .188 DOM steel, urethane upper

bushings on rubber lower bushing included. Upper arms have a "problem solver" offset shaft to tune camber and the upper ball joint set back 3/4" for more caster. Early 57 may have 2 different length upper arms... need to measure the length of originals. The 64 cars with the "cranked" forward control arms bolt can be upgraded on request to use a conventional bolt. Sold in plain steel. -0  
..... **\$1,030.00 L&R** ⚠

**Digital Gauges (Dakota Digital)**

Quad air pressure gauge can monitor & simultaneously display the front & rear pressure on front/rear air ride systems. On four wheel, fully independent air ride systems the unit can individually monitor & simultaneously display each wheel's air bag for proper pressure & subsequent ride height. Can also display air tank pressure.



**AR1503** .....ALL  
Air ride gauge with 3 senders, use for front/rear plus tank applications. 10.260 -0.15  
..... **\$270.00 SET** ⚠



**AR1504** .....ALL  
Air ride gauge with 4 senders, use for all 4 corner applications. 10.230 -0.15  
..... **\$270.00 SET** ⚠

**AR1505** .....ALL  
Air ride gauge with 5 senders, use for all 4 corner plus tank applications. 10.230 -0.15  
..... **\$310.00 SET** ⚠

**AR4002** .....ALL  
Air ride gauge with 2 senders, use for front/rear applications. 10.260 -0.15  
..... **\$300.00 SET** ⚠

**AR4003** .....ALL  
Air ride gauge with 3 senders, use for front/rear plus tank applications. 10.260 -0.15  
..... **\$300.00 SET** ⚠

**AR4004** .....ALL  
Air ride gauge with 4 senders, use for all 4 corner applications. 10.260 -0.15  
..... **\$360.00 SET** ⚠

**A-Arm Adjusters**



**13270** .....ALL  
5/8in. multi angle polished for suspension A-arms. 6.169 -0.15  
..... **\$83.25 EA** ⚠



**13271** .....ALL  
5/8in. straight angle polished for suspension A-arms. 6.169 -0.15  
..... **\$52.00 EA** ⚠

**Spindle Nut & Washer**



**378137M** .....ALL  
Nut, washer & lock pin. Mustang II/Pinto spindles (does 2). 6.022 -0.2  
..... **\$10.50 SET** ⚠

**Sway Bar-Front - Chevy**

**599593** ..... 32-38  
Car Front Sway Bar 1" -0  
..... **\$229.00 EA** ⚠  
**599394** ..... 39-48  
Car Front Sway Bar 1" -0  
..... **\$295.00 EA** ⚠  
**3688966** ..... 49-50  
Car Front Sway Bar 1" -0  
..... **\$295.00 EA** ⚠

**Sway Bar - Front- Ford**

**B9A5482B** ..... 59  
Car Front Sway Bar Galaxie 1" -0  
..... **\$295.00 EA** ⚠  
**C2AS5482A** ..... 60-64  
Car Front Sway Bar Galaxie 1" -0  
..... **\$295.00 EA** ⚠



## 49-54 CHEVY CAR FRAME

Bare frame with suspension starting at \$14,005

Complete frame with suspension, brakes, third member & more! ⚠️

Starting at \$17,315

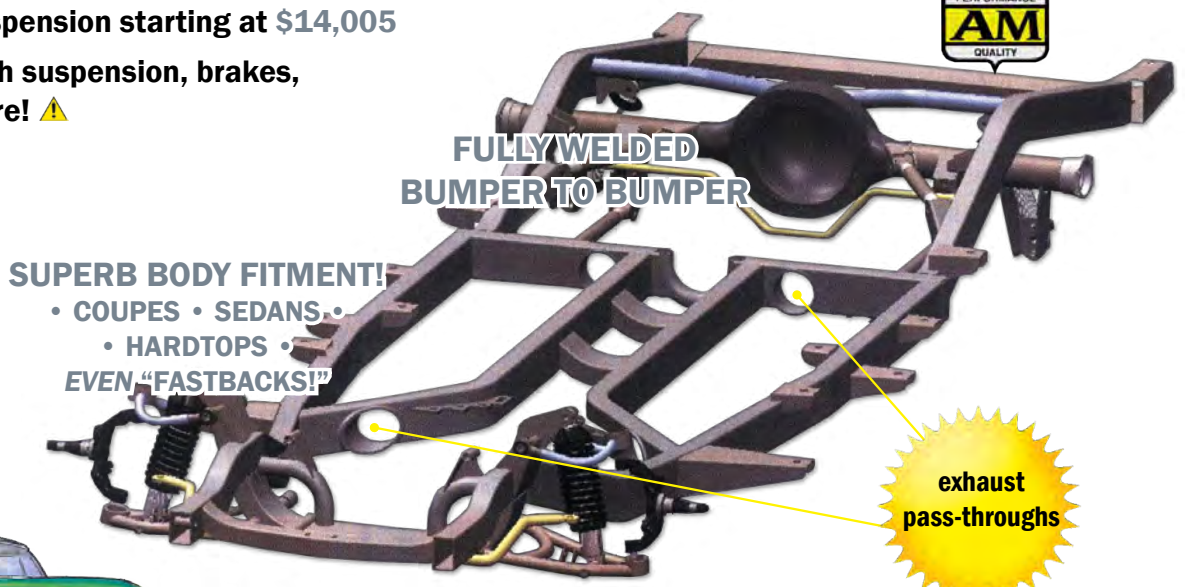

Frame used on the 2009 *Street Rodder* Magazine Road Tour Car. Chevs of the 40's is the official restoration parts supplier for the '52 Hardtop.

## '47-'53 CHEVY TRUCK CHASSIS

Start off on the right foot with this CAD-engineered chassis. 2" x 8" fully boxed rails and a rigid "K" member designed for strength and durability. Order as Base or Complete Chassis. Call for complete information. ⚠️

### Base Chassis includes:

- 6 Bolt-on running board brackets
- Cab mounts
- Front body mount
- Engine & transmission mounts
- Complete Mustang II front end
- Brake pedal & bracket
- Currie 9" rear axle housing with 31 spline axles (standard)
- Rear parallel leaf spring kit
- Rear shocks

Starting at \$10,280

### Options & Upgrades

- Tubular IFS front end
- Chrome/stainless front suspension upgrade
- 4-Link rear suspension
- 3<sup>rd</sup> members
- Air bag suspension upgrade
- Sway bars
- Steel brake lines installed

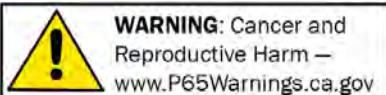
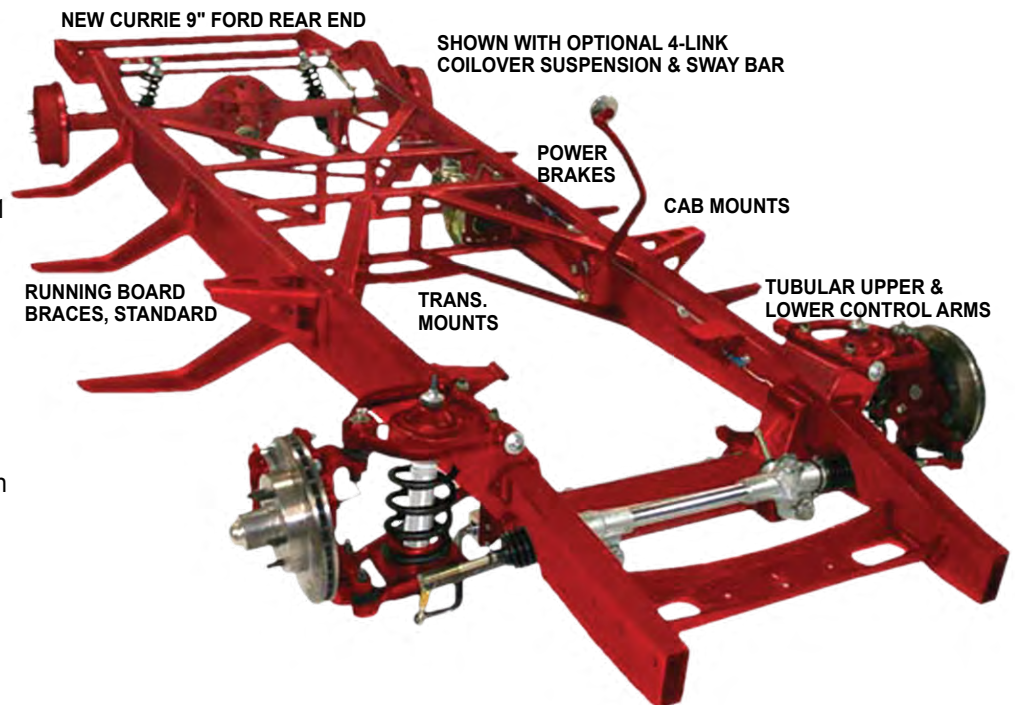

NOTE: Any chemicals will be shipped domestic ground only (Lower 48 states only). No international shipping.

(800) 952-1752 • [www.streetrodhq.com](http://www.streetrodhq.com)

## Corvette C4-IFS & IRS Installation Kits for 47-53 Chevy Trucks

Now you can have the ride, superior handling, cornering and braking provided only by the advanced technology built into the Corvette suspension.



We offer quality kits to adapt the late model ('84-'87 and '88-'95) Corvette front and rear independent suspensions to your '47-'55 Chevy truck. (Suspension not included.)



These kits are designed to fit your frame. All brackets are laser cut from cold rolled steel and heli-arc welded for strength and unsurpassed good looks.

These kits utilize Corvette C-4 front and rear suspension components mounted to your frame using the stock Corvette geometry. The real bonus is this system uses the stock Corvette Power Rack and Pinion Steering Unit as designed by

Gm, eliminating and "bump steer" problems inherent with units from vehicles designed in the '70s with light weight vehicles and economy in mind. You can GM sports car handling on your GM manufactured truck. All the corvette suspension components are manufactured from forged aluminum which allows you to decrease vehicle weight while also maintaining strength and a solid suspension.



Not only will you be amazed at how well your truck rides but how fun it will be drive with a Corvette front and rear suspension installed. And let's not forget 4-wheel disc brakes designed to mount to your suspension.

Available **Aldan Eagle coilover shocks** for front or rear allow you to adjust the ride to your liking with 6-position adjustable compression damping and spring rate adjustment also. Rugged construction and combination of oil and gas charging incorporated in each shock are only part of the reason we recommend them with our IFS and IRS kits. Kits complete with instructions and all hardware.



You'll enjoy the handling and new life brought to your truck with these very affordable suspension kits for years to come.

### FRONT CROSSMEMBER ⚠

SUSCORF1	84-87 C-4 IFS-front without coilover shocks (see below) . . . .	\$845.00
SUSCORF2	88-96 C-4 IFS-front without coilover shocks (see below) . . . .	\$895.00

### REAR CROSSMEMBER ⚠

SUSCORR1	84-87 C-4 IRS-rear without coilover shocks (see below) . . . .	\$750.00
SUSCORR2	88-96 C-4 IRS-rear without coilover shocks (see below) . . . .	\$765.00

### ALDAN COILOVER SHOCKS ⚠

SHOCKF1	Front shock . . . . .	\$399.00 pr
SHOCKF2	Front shock w/ chrome springs . . . . .	\$567.00 pr
SHOCKF3	Front shock w/ polished housing . . . . .	\$533.25 pr
SHOCKF4	Front shock w/ chrome sprints & polished housing . . . . .	\$641.25 pr
SHOCKR1	Rear shock . . . . .	\$399.00 pr
SHOCKR2	Rear shock w/ chrome springs . . . . .	\$567.00 pr
SHOCKR3	Rear shock w/ polished housing . . . . .	\$533.25 pr
SHOCKR4	Rear shock w/ chrome sprints & polished housing . . . . .	\$641.25 pr



Returns require a return authorization number—Please call first. · Note: Product pricing and availability subject to change.

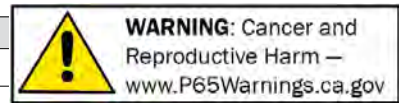

**Here's what you get with Heidt's:**

Cast aluminum alloy center housing and outer uprights, Ford 9i third member with your choice of gears, steel halfshafts assembled with inner flanges and outer yokes including 1350 heavy duty U-joints, new forged inner stub axles with bearings and seals, Wilwood inboard disc brake setup with rotors, polished calipers & aluminum caliper plates, Corvette outer bearing assemblies and flanges, tubular lower control arms with adjusters, outer mounting brackets, pinion support crossmember with urethane bushed links. Forward struts with urethane bused ends are also included. Tread widths for all the popular applications from 55i to 62i are standard and custom widths can be ordered. Your Superide IRS is shipped to you complete, hub to hub, by UPS - with no other parts to buy. This saves you expensive crating and truck freight charges, making it the best IRS value on the market.

Here is what is included free in Heidt's basic IRS unit.

- Chrome Springs \$60
- Performance Gears \$260
- Billet Coil-overs \$110
- Polished Calipers \$120
- Pinion Supports (required)
- Forward Struts \$300
- Value received free \$850

**Suspension - Superide IRS**



**SUPERIDE-IRS** .....ALL  
5.387 -0 ..... \$8,293.00 SET ⚠

**Suspension - Superide IRS -Upgrades**

**SUPERIDE-IRS01** ..... ALL  
Heidt's Superide II IRS upgrade item. Chrome half-shaft package. Includes: chrome half shafts, inner flanges, outer axle yokes & U-joint straps, polished rotor & caliper mounting plates plus polished billet coil-overs. -0  
..... \$777.00 SET ⚠

**Suspension - Superide IRS -Upgrades, cont.**



**SUPERIDE-IRS02** .....ALL  
Heidt's Superide II IRS upgrade item. Polished stainless lower arms with polished adjusters and polished stainless tie bars, polished center housing, polished outer uprights, polished stainless full hardware, -0 ..... \$1,572.00 SET ⚠

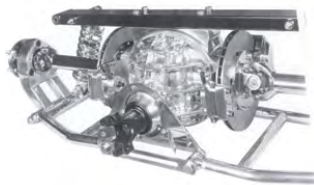

**SUPERIDE-IRS03** .....ALL  
Heidt's Superide II IRS polished aluminum 3rd member - upgrade only. -0 ..... \$2,758.00 SET ⚠

**SUPERIDE-IRS04** ..... ALL  
Heidt's Superide II IRS polished parking brake kit - upgrade. -0.15 \$373.00 SET ⚠

**SUPERIDE-IRS05** ..... ALL  
Heidt's Superide II IRS positraction - upgrade. -0 ..... \$1,386.00 EA ⚠

**SUPERIDE-IRS06** .....ALL  
Heidt's Superide II IRS Ford bolt pattern - option. -0 ..... \$59.00 EA ⚠

**SUPERIDE-IRS07** ..... ALL  
Heidt's Superide II IRS polished stainless pinion support - option. -0 ..... \$259.00 EA ⚠

**SUPERIDE-IRS10** ..... ALL  
Heidt's Superide II IRS polished billet pinion yoke - optional. -0 . \$425.00 EA ⚠

**SUPERIDE-IRS11** ..... ALL  
Heidt's Superide II IRS chrome outer bearing assemblies - option. -0 ..... \$329.00 EA ⚠

**SUPERIDE-IRS13** ..... ALL  
Heidt's Superide II IRS polished stainless forward struts - option. -0 \$259.00 EA ⚠

**SUPERIDE-IRS14** ..... ALL  
Heidt's Superide II IRS polished caliper covers - option. -0 .... \$119.00 EA ⚠

**C4 Corvette IRS Install Kit**

Make your 47-54 Chevy truck handle and stop like a 'vette. These kits install donor C4 (1984-96) Corvette rear suspension. For complete details see Section 205.



SHOWN ASSEMBLED WITH DONOR C4 PARTS AND KIT COMPONENTS

**SUSCORR1** .....36-54  
6.008 -0.15 ..... \$749.75 SET ⚠

**SUSCORR2** ..... 36-54  
6.008 -0.15 ..... \$765.00 SET ⚠

**SUSCORFRBUSH** . .ALL  
Front and rear urethane bushing kit 6.008 -0.15  
..... \$300.00 SET ⚠

**SUSCORRBUSH** . .ALL  
Rear Urethane Bushing Kit 6.008 -0.15  
..... \$150.00 SET ⚠

**C5 Rear Sub Frame**



**C5CONVR** .....ALL  
This is a C5 Corvette rear suspension conversion. This is a Weld In Rear Sub-Frame that uses C5 suspension components. Track width hub to hub is 66-3/8". Components not included. -0.15  
..... \$2,200.00 EA ⚠

**Rear Axle Mounting Kit - 37-39 Chevy Car**

**AS-1018C** .....37-39  
Open drive line rear ends. Mounting kit with standard shocks. 7.503 -0  
..... \$748.75 EA ⚠

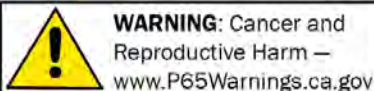

NOTE: Any chemicals will be shipped domestic ground only (Lower 48 states only). No international shipping.



**Rear Axle Mounting Kit - 37-39 Chevy Car, cont.**



**AS-1018CG** ..... 37-39  
Open drive line rear ends. Mounting kit with gas shocks. 7.503 -0 ... **\$748.75 EA** ⚠️



**SB-1037R** ..... 37-39  
For use with rear axle mounting kit. 7.503 -0 ..... **\$185.00 EA** ⚠️

**Rear Axle Mounting Kit - 40-48 Chevy Car**

**AS-1020CG** ..... 40  
Open drive line rear ends. Mounting kit with gas shocks. Lowers car approx. 3". 7.503 -0 ..... **\$749.00 EA** ⚠️



**SB-1040R** ..... 40  
Rear. Compliments use of front sway bar. Includes bushings and mounts. State housing sizes when ordering. For use with rear axle mounting kit. 7.241 -0 ..... **\$185.00 EA** ⚠️

**AS-1019CG** ..... 41-48  
Open drive line rear ends. Mounting kit with gas shocks. Lowers car approx. 3". 7.503 -0.15 ..... **\$1,294.25 EA** ⚠️

**SB-1048RA** ..... 41-48  
Rear. Compliments use of front sway bar. Includes bushings and mounts. For use with C.E. rear shock kits only. Will not fit original rear suspension. 7.241 -0 ..... **\$185.00 EA** ⚠️

**Rear Axle Mounting Kit - 49-54 Chevy Car**



**AS-1021** ..... 49-54  
Leaf spring mounting brackets only. Bolt on. Use with Chassis Engineering 2-1/2" wide slider springs. Includes front and rear spring mounts. 7.112 -0 ... **\$130.00 SET** ⚠️

**AS-1021C** ..... 49-54  
Open Drive Line Rear ends. Bolt-on mounting kit. With standard shocks 7.503 -0 ..... **\$749.00 SET** ⚠️



**AS-1021CG** ..... 49-54  
Chevy (Nova, Camaro, Firebird) rear ends. Mounting kit with gas shocks. 7.503 -0.15 ..... **\$1,150.25 SET** ⚠️

**Rear Axle Mounting Kit - 37-46 Chevy Truck**



**AS-0010CGY** ..... 37-46  
Weld in with gas shocks 7.503 -0 ..... **\$749.00 EA** ⚠️

**Rear Axle Mounting Kit - 47-54 Chevy Truck**

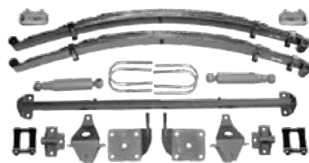

**AS-1015C** ..... 47-54  
Bolt on kit with standard shocks. 7.503 -0 ..... **\$749.00 EA** ⚠️

**AS-1015CG** ..... 47-54  
Bolt on w/ gas shocks. 7.503 -0 ..... **\$749.00 EA** ⚠️

**Rear Axle Mounting Kit - 47-54 Chevy Truck, cont.**



**SB-4754RA** ..... 47-54  
This sway bar for the rear complements use of a front sway bar. Includes bushings, mounts, and all linkage and mounting hardware. State housing sizes when ordering. For best results use front and rear sway bars together. 7.503 -0 ..... **\$225.00 EA** ⚠️

**Rear Shock Kit - 40-48 Chevy Car**

**AR-1043G** ..... 41-48  
Kit includes upper shockbar, 2 gas shock absorbers, 2 lower spring plates, shock mounts & all needed bolts & instructions. Some models may require spare tire well modification also. 7.395 -0 ..... **\$250.00 SET** ⚠️

**Rear Axle Spring Pads - Weld On**

**AU-2229** ..... ALL  
7.503 -0 ..... **\$30.00 EA** ⚠️

**Airbags**

**AIRBAG2500** . . . . ALL  
2500lb bag, 1/2" ports. 2 mounting holes top (1-3/4" center-to-center), 1 bottom. -0.15

..... **\$59.00 EA** ⚠️  
**AIRBAG25002** . . . . ALL  
DeNominator II  
2500lb, 600psi bag, 1/2" ports. 2 mounting holes top (1-3/4" center-to-center), 1 bottom.

6.25" dia.  
2.8" collapsed  
10.5" extended -0.15  
..... **\$79.00 EA** ⚠️

**AIRBAG2600** . . . . ALL  
2600lb bag, 1/2" ports. 2 mounting holes top (2-3/4" center-to-center), 1 bottom. -0.15

..... **\$59.00 EA** ⚠️

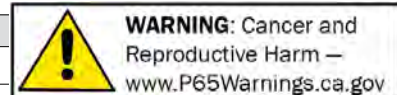

**Airbags, cont.**



**AIRBAG26002 . . . .ALL**  
DeNominator II 2600lb,  
500psi. bag, 1/2"  
ports. 2 mounting holes  
top (2-3/4" center-to-  
center), 1 bottom.  
7.25" dia.

2.8" collapsed  
11.5" extended -0.15

**\$79.00 EA** ⚠

**AirWave Shocks**



**AIRWAVE00 . . . . .ALL**  
2500lb. non-adjustable, built-in shock and  
bag. -0.15 . . . . . **\$600.00 PR** ⚠

**AIRWAVE01 . . . . .ALL**  
2500lb., 10 position adjustable, built-in  
shock and bag. -0.15 . . . . . **\$750.00 PR** ⚠

**4-Link Rear Suspension**

Parallel 4 link rear suspension using heavy  
tubing & lasercut bracketry. Uses a panhard  
bar to position the rear axle side to side. Fewer  
bar mounts than other 4-link systems means  
easier to install.

Kit offers:

Superior ride quality & handling

Rubber bushings eliminate poly bushing  
squeak

Highly adaptable to most vehicles

Bolt-on panhard bar available for many  
applications

Simple, straightforward installation. Only 4  
brackets to locate and weld

.219" wall direct threaded DOM tubing for  
maximum strength

.188" wall alloy steel bracketry is CNC lasercut  
and folded for strength and accuracy.



**4LINKHP . . . . .ALL**  
Parallel 4-Link for heavy cars over  
4000lbs. -0.15 . . . . . **\$375.00 KIT** ⚠

**4-Link Rear Suspension, cont.**



**4LINKHT . . . . .ALL**  
Triangulated 4-Link for heavy cars over  
4000lbs. -0.15 . . . . . **\$333.00 KIT** ⚠

**4LINKLP . . . . .ALL**  
Parallel 4-Link for light weight cars under  
4000lbs. -0 . . . . . **\$350.00 KIT** ⚠

**4LINKLT . . . . .ALL**  
Triangulated 4-Link for light weight cars  
under 4000lbs. -0.15 . . . . . **\$245.00 KIT** ⚠

**Rear Sway Bar - Chevy**

**599592 . . . . . 32-38**  
Car Rear Sway Bar 3/4" -0  
. . . . . **\$199.00 EA** ⚠

**599595 . . . . . 39-48**  
Car Rear Sway Bar 3/4" -0  
. . . . . **\$275.00 EA** ⚠

**Rear Sway Bar - Ford**

**B9A5483B . . . . . 59**  
Car Rear Sway bar Galaxie 7/8" -0  
. . . . . **\$275.00 EA** ⚠

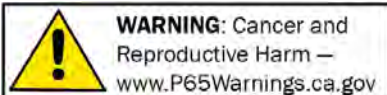

**WARNING: Cancer and  
Reproductive Harm —**  
[www.P65Warnings.ca.gov](http://www.P65Warnings.ca.gov)

NOTE: Any chemicals will be shipped domestic ground only (Lower 48 states only). No international shipping.

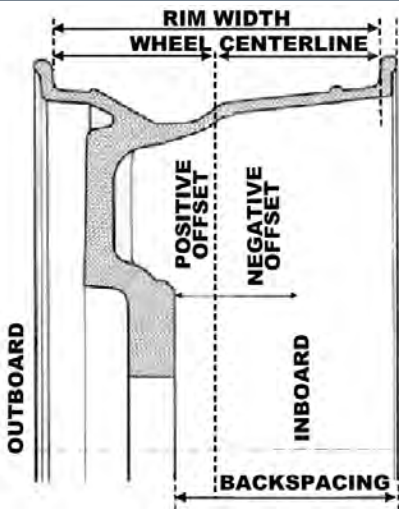

**Custom Wheel Artillery (Bare)**



**AB** ..... **ALL**  
 Bare Steel Artillery Rim. 15" Only. Specify width and backspace. Available in 5,6,7,8,10,12,14 inch widths. 5x4-3/4", 6x5-1/2" Chevy or 5x4-1/2" Ford lug patterns. -0 ..... **starting at \$157.00 EA** ⚠

**Custom Wheel Artillery (Chrome)**



**AC** ..... **ALL**  
 All Chrome Artillery Rim. 15" Only. Specify size, width and backspace. Available in 5,6,7,8,10,12,14 inch widths. 5x4-3/4", 6x5-1/2" Chevy or 5x4-1/2" Ford lug patterns. -0 ..... **starting at \$239.00 EA** ⚠

**Custom Wheel Nostalgia (Bare)**



**NB** ..... **ALL**  
 Bare Steel Rim: 14, 15 or 16" Rims Specify size, width and backspace. Available in 5,6,7,8,10,12,14 inch widths. 5x4-3/4", 6x5-1/2" Chevy or 5x4-1/2" Ford lug patterns. -0 ..... **starting at \$77.00 EA** ⚠

**Custom Wheel Nostalgia (Chrome Rim)**



**NCC** ..... **ALL**  
 Chrome rim, bare steel center. 14, 15 or 16" Rims Specify size, width and backspace. Available in 5,6,7,8,10,12,14 inch widths. 5x4-3/4", 6x5-1/2" Chevy or 5x4-1/2" Ford lug patterns. -0 ..... **starting at \$100.00 EA** ⚠

**Custom Wheel Nostalgia (Chrome)**



**NC** ..... **ALL**  
 All Chrome Rim. 14, 15 or 16" Rims Specify size, width and backspace. Available in 5,6,7,8,10,12,14 inch widths. 5x4-3/4", 6x5-1/2" Chevy or 5x4-1/2" Ford lug patterns. -0 ..... **starting at \$105.00 EA** ⚠

**Custom Wheel Rally (Bare)**



**RB** ..... **ALL**  
 Rallye Bare Steel. 14, 15 or 16" Rims Specify size, width and backspace. Available in 5,6,7,8,10,12,14 inch widths. 5x4-3/4", 6x5-1/2" Chevy or 5x4-1/2" Ford lug patterns. -0 ..... **starting at \$88.00 EA** ⚠

**Custom Wheel Rally (Chrome Rim)**



**RCC** ..... **ALL**  
 Chrome rim with bare steel center. 14, 15 or 16" Rims Specify size, width and backspace. Available in 5,6,7,8,10,12,14 inch widths. 5x4-3/4", 6x5-1/2" Chevy or 5x4-1/2" Ford lug patterns. -0 ... **CALL** ⚠

**Custom Wheel Rally (Chrome)**



**RC** ..... **ALL**  
 All Chrome Rim: 14, 15 or 16" Rims Specify size, width and backspace. Available in 5,6,7,8,10,12,14 inch widths. 5x4-3/4", 6x5-1/2" Chevy or 5x4-1/2" Ford lug patterns. -0 ..... **starting at \$116.00 EA** ⚠

**Hub Caps-Modified for Chevy Artillery / Nostalgia Steel Wheels**



**594453M** ..... **37-38**  
 Modified for artillery / nostalgia wheel 5.858 -0.15 ..... **\$120.25 EA** ⚠

**Hub Caps-Modified for Chevy Artillery / Nostalgia Steel Wheels, cont.**

**594453MS** ..... **37-38**  
Stainless. Modified for artillery / nostalgia wheel. 5.858 -0.15 ..... **\$43.00 EA** ⚠

**599748MS** ..... **39**  
Stainless. Modified to fit artillery / nostalgia wheel. 5.858 -0.15 .. **\$44.00 EA** ⚠



**654307M** ..... **40**  
Chrome. Modified to fit artillery / nostalgia wheel. 5.858 -0 ..... **\$35.00 EA** ⚠



**3658374M** .... **41-48**  
1941-48 Passenger (41-46 Commercial exc 46 1Ton). Modified to fit artillery / nostalgia wheel. 5.858 -0.15 ..... **\$65.00 EA** ⚠



**3658374MS** ... **41-48**  
Stainless 1941-48 Passenger (41-46 Commercial exc. 46 1Ton) For artillery / nostalgia wheels 5.858 -0.15 ..... **\$65.00 EA** ⚠



**3705092A** ..... **47-53**  
1/2Ton, modified to fit nostalgia wheel. Chrome 5.858 -0.15 ..... **\$84.75 EA** ⚠

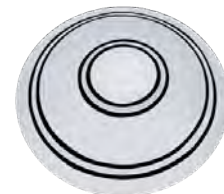

**3908671** ..... **ALL**  
Police, plain. Fits artillery / nostalgia wheel. 5.858 -0.3 ..... **\$22.00 EA** ⚠

**MODIFY** ..... **ALL**  
Modify your hub cap to fit custom artillery / nostalgia or rally wheel 5.858 -0.15 ..... **\$60.00 EA** ⚠

**Hub Caps-Modified for Chevy Rally Steel Wheels**



**594453MRS** ..... **37-38**  
Stainless. Modified for rally wheel. 5.858 -0.2 ..... **\$82.00 EA** ⚠



**3705092M** ..... **37-48**  
Baby moon, 37-48 Cars. 37-46 1/2Ton & 37-41 3/4Ton. 5.858 -0.15 . **\$178.25 SET** ⚠



**599748MR** ..... **39**  
Chrome. Modified to fit rally wheel. 5.858 -0 ..... **CALL** ⚠

**599748MRS** ..... **39**  
Stainless. Modified to fit rally wheel. 5.858 -0 ..... **\$72.69 EA** ⚠



**654307MR** ..... **40**  
Chrome. Modified to fit rally wheel. 5.858 -0.15 ..... **CALL** ⚠



**3658374MR** ..... **41-48**  
1941-48 Passenger (41-46 Commercial exc 46 1Ton) Modified to fit rally wheel. 5.858 -0.2 ..... **\$75.59 EA** ⚠

**Hub Caps-Modified for Chevy Rally Steel Wheels**



**3705092AR** ..... **47-53**  
1/2Ton, modified to fit rally wheel. 5.858 -0.15 ..... **\$49.99 EA** ⚠



**3908672** ..... **ALL**  
Police, plain. Fits rally wheel. 5.858 -0.15 ..... **\$50.00 EA** ⚠

**MODIFY** ..... **ALL**  
Modify your hub cap to fit custom artillery / nostalgia or rally wheel 5.858 -0.15 ..... **\$60.00 EA** ⚠

**Hub Caps-Custom**

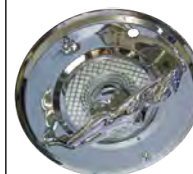

**3705092N** ..... **ALL**  
14 in. Nude Figure. Chrome. 5.858 -0.15 ..... **\$298.69 SET** ⚠

**3705092Z** ..... **ALL**  
15 in. nomad style. chrome -0 ..... **\$105.00 EA** ⚠



**HCAPCADDY16** . . . **ALL**  
16" Cadillac Sombbrero -0.15 ..... **\$222.75 SET** ⚠



**HCAPCROSS14** . . **ALL**  
14 inch Crossbar style. 5.858 -0.15 ..... **\$244.00 SET** ⚠

**HCAPCROSS15** ..... **ALL**  
15 inch Crossbar style. 5.858 -0.15 ..... **\$242.75 SET** ⚠



**HCAPLANCER** . . . **ALL**  
15 inch 59 Lancer style. 5.858 -0.15 ..... **\$274.59 SET** ⚠

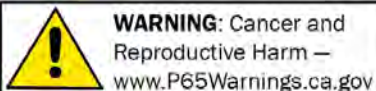

**WARNING: Cancer and Reproductive Harm** — [www.P65Warnings.ca.gov](http://www.P65Warnings.ca.gov)

NOTE: Any chemicals will be shipped domestic ground only (Lower 48 states only). No international shipping.

**Hub Caps-Custom, cont.**



**HCAPLANCERB14 .ALL**  
14 inch 57 Lancer style.  
5.858 -0.15  
..... **\$221.00 SET** ⚠

**HCAPLANCERB15..... ALL**  
15 inch 57 Lancer style. 5.858 -0.15  
..... **\$215.59 SET** ⚠



**HCAPPOLARA15 .ALL**  
15" Polara Style custom  
hub caps(set of 4)  
5.858 -0.15  
..... **\$274.25 SET** ⚠



**HCAPSBURST14 .ALL**  
14 inch Starburst Style  
5.858 -0.15  
..... **\$105.25 SET** ⚠



**HCAPSBURST15 .ALL**  
15 inch Starburst Style  
5.858 -0.15  
..... **\$79.75 SET** ⚠



**HCAPSOMBRERO16 . . ALL**  
Wheel Covers Bullet  
Sombrero Style 16"-  
Set of 4 -0.15  
..... **\$215.59 SET** ⚠

**Bullet Hub Center Caps**



**KA8016.....ALL**  
Chrome bullet with  
plastic lug nut cover, 5 x  
4-1/2" lug pattern. -0.15  
..... **\$40.00 EA** ⚠



**KC6017.....ALL**  
Chrome bullet with  
plastic lug nut cover, 5 x  
4-3/4" lug pattern. -0.15  
..... **\$73.19 PR** ⚠



**KC6050.....ALL**  
Chrome bullet with  
plastic lug nut cover, 6 x  
5-1/2" lug pattern. -0.15  
..... **\$52.99 EA** ⚠

**Beauty Rings**



**1279680.....ALL**  
Ribbed 16 in. (outer  
wheel). 5.858 -0.15  
..... **\$29.50 EA** ⚠

**1279680S..... ALL**  
Smooth 16 in. (outer wheel). 5.858 -0.15  
..... **\$26.75 EA** ⚠

**986214..... ALL**  
14in. (outer wheel). 5.858 -0.15  
..... **\$40.00 EA** ⚠

**986259..... ALL**  
Ribbed 15 in. (outer wheel). 5.858 -0.15  
..... **\$29.79 EA** ⚠

**986259S..... ALL**  
Smooth 15 in. (outer wheel). 5.858 -0.15  
..... **\$24.98 EA** ⚠

**Tire - White Wall, Radial**



**368981R.....ALL**  
(670x15) Coker classic.  
2-3/8 in. white wall  
5.804 -0  
..... **\$242.50 EA** ⚠

**368982R.....ALL**  
(670x16) Diamond Back Classics 3 in.  
white wall . Tubeless. 5.804 -0  
..... **\$269.00 EA** ⚠



**3693215R.....ALL**  
(650x16) Diamond  
Back Classics 3-1/2 in.  
white wall. Tubeless.  
5.804 -0  
..... **\$289.00 EA** ⚠



**3693215RC.....ALL**  
(650x16) Coker Classic  
3-1/4 in. white wall.  
5.804 -0  
..... **\$340.00 EA** ⚠

**Tire - White Wall, Bias Ply**

**368981.....ALL**  
(670x15) Coker, BF Goodrich 3-5/8 in.  
white wall tubeless 5.804 -0  
..... **\$231.75 EA** ⚠

**3693215.....ALL**  
(650x16) Coker, BF Goodrich 3-3/4 in.  
white wall 5.804 -0  
..... **\$245.75 EA** ⚠



**3693215F.....ALL**  
(650x16) Coker,  
Firestone 3-1/4 in.  
white wall. 5.804 -0  
..... **\$245.00 EA** ⚠

**Tire - Black Wall, Radial**



**599887R.....ALL**  
(600x16) Coker,  
BF Goodrich. Made  
from original molds.  
5.804 -0.15  
..... **\$330.00 EA** ⚠

**Tire - Black Wall, Bias Ply**

**368981B.....ALL**  
(670x15) Coker, BF Goodrich. Tubeless.  
5.804 -0  
..... **\$202.00 EA** ⚠

**3693215B.....ALL**  
(650x16) Coker, BF Goodrich. 5.804 -0  
..... **\$211.50 EA** ⚠



**599887.....ALL**  
(600x16) BF Goodrich.  
4 ply. Made from  
original moulds. 5.804 -0  
..... **\$197.75 EA** ⚠

**Tube**



**599885.....ALL**  
600-650 x 16 5.804 -0  
..... **\$25.00 EA** ⚠

**Tire Care**



**WHITEWIPE.....ALL**  
Bleach free white wall  
tire wipes. 7" x 9" wipe.  
35 per container. -0  
..... **CALL** ⚠

**Nude Lady**



**3705092H.....ALL**  
3 dimensional nude figure handle or  
hubcap ornament. Chrome, 12-1/4 in.  
length. 5.858 -0.15  
..... **\$43.19 EA** ⚠

**Valve Stem Caps**



**CROWCAPGD . . . .ALL**  
 Crown cap. Gold plastic  
 (5 pcs). 5.804 -0  
 . . . . . \$9.49 SET ⚠



**CROWCAPR . . . .ALL**  
 Crown cap. Red plastic  
 (5 pcs). 5.804 -0.15  
 . . . . . \$6.25 SET ⚠



**VC69978 . . . . .ALL**  
 Chrome Large 8 Ball Valve Cap -0.15  
 . . . . . \$6.75 SET ⚠



**VC69981 . . . . .ALL**  
 Chrome Dice Valve Caps -0.2  
 . . . . . \$4.99 SET ⚠



**VC70004 . . . . .ALL**  
 Skull Valve Caps -0.15 . . \$6.00 SET ⚠



**VC70005 . . . . .ALL**  
 Dice Valve Caps-Red With White Dots -0.15  
 . . . . . \$4.00 SET ⚠



**VC70006 . . . . .ALL**  
 Dice Valve Caps-White With Black  
 Dots -0.15 . . . . . \$4.00 SET ⚠

**Valve Stem Caps, cont.**



**VC70007 . . . . .ALL**  
 Dice Valve Caps-Black With White  
 Dots -0.15 . . . . . \$4.00 SET ⚠



**VC70008 . . . . .ALL**  
 Dice Valve Caps- Blue With White  
 Dots -0.15 . . . . . \$4.00 SET ⚠



**VC70022 . . . . .ALL**  
 8 Ball Valve Caps -0.15 . \$4.00 SET ⚠



**VC70038 . . . . .ALL**  
 Chrome Spike Valve Caps -0.15  
 . . . . . \$6.50 SET ⚠



**VC70054 . . . . .ALL**  
 Dice Valve Caps- Purple With White  
 Dots -0.15 . . . . . \$4.00 SET ⚠



**WARNING: Cancer and  
 Reproductive Harm —  
 www.P65Warnings.ca.gov**

NOTE: Any chemicals will be shipped domestic ground only (Lower 48 states only). No international shipping.

**Continental Kit**



**987265C** .....49-50  
Complete kit w/ full face cover & chrome tread cover. 7.629 -0.15 **\$1,935.00 KIT**  
⚠️



**987265D** .....51-52  
Complete kit w/ full face cover & chrome tread cover. 7.629 -0.15 **\$1,935.00 KIT**  
⚠️



**987265** .....53-54  
Complete kit w/ full face cover & chrome tread cover. 7.629 -0.15 **\$1,936.00 KIT**  
⚠️

**Briz Bumpers**

Oversized shipping charges applies on all bumpers. Please call for rates.



**BRIZ5RIB** .....35-54  
Original 5 rib, fully polished (front and rear) alloy bumper. Fits 35-48 Chevy cars, 41+54 Chevy trucks. 4-1/2 in. face. Mount Front or Rear. 7.831 -0.15 ... **\$308.00 EA**  
⚠️

**Briz Bumpers, cont.**



**BRIZ5RIB-C** .....47-54  
5 rib polished alloy contoured bumper. Contoured to match the front of your truck. Fits 47-54 Chevy trucks. 4-1/2 in. face (does not include brackets or bolts). -0.15 ..... **\$426.25 EA** ⚠️



**BRIZ3RIB** .....ALL  
3 rib, fully polished (on both sides) alloy bumper. Fits 28-40 Chevy cars. 2-7/8 in. face. 7.831 -0.15 ..... **\$285.00 EA** ⚠️



**BRIZ5RIB-SH** .....ALL  
Original 5 rib polished alloy bumper. Fits 49-53 Chevy cars, 41-54 Chevy trucks. 4-1/2 in. face. 7.831 -0.15 .. **\$308.00 EA**  
⚠️

**Briz Bumper Bolts**



**BRIZBOLT** .....ALL  
Polished, Stainless bumper bolt. Radiused head to fit over ribs. -0.15 .. **\$10.75 EA**  
⚠️

**Briz Bumper License Guard/Bracket**

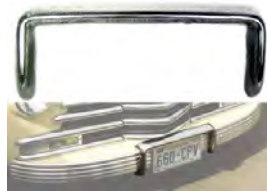

**BRIZBGUARD** .....ALL  
Polished. '49 Chevy style. -0 ..... **\$190.00 EA** ⚠️

**Briz Bumper License Guard/Bracket, cont.**



**BRIZBRKT** .....ALL  
License plate mounting bracket for BRIZ license guard. -0.15 ..... **\$29.50 EA** ⚠️

**Bumpers -Polished Stainless - Chevy**

Oversized shipping charges applies on all bumpers. Please call for rates.



**594528** ..... 37  
Polished Stainless. Front or rear. Fits Master Deluxe. No holes. Studs for brackets welded to back. 7.831 -0.15 ..... **\$498.75 EA** ⚠️



**594648S** ..... 37  
Polished Stainless. Fits on Master front & Front or Rear on trucks. 7.831 -0.15 ..... **\$498.75 EA** ⚠️



**3847305S** .....38-39  
Polished Stainless. Front or Rear. No holes. Studs for brackets welded to back. 7.831 -0.15 ..... **\$498.75 EA** ⚠️



**3653339S** ..... 40  
Polished Stainless. No holes. Studs for brackets welded to back. Fits front or rear (exc. rear of Wagon & Sedan Delivery). 16.400 -0.15 ..... **\$498.75 EA** ⚠️



**3658265S** .....41-46  
Polished stainless. Front with bolt holes (exc 41-42 COE & 46 1-1/2Ton w/ 160 in. wheelbase). 7.831 -0 ..... **\$460.00 EA** ⚠️

**Bumpers -Polished Stainless - Chevy, cont.**



**3658265SA** .....41-46  
 Polished stainless.  
 Rear with bolt holes. Fits 1/2Ton & 3/4Ton  
 Truck (panels & Suburbans w/ doors had  
 1-1/2 in. less arc). 7.831 -0 ..... **\$460.00 EA** ⚠



**3683350S** .....47-53  
 Polished stainless. Rear, exc. Panel &  
 Suburban. Nice!. Chevy & GMC 7.831 -0.15  
 ..... **CALL** ⚠



**3700438S** .....47-54  
 Polished stainless  
 Front, also fits rear of Panel & Suburban.  
 Chevy & GMC 7.831 -0.15 ... **\$289.50 EA** ⚠

**Bumpers Chrome Ford**

**1939 FORD SHOWN**



**22968** ..... 37  
 Passenger - front only, Pickup - front and  
 rear Chrome Plated -0 ..... **\$400.00 EA** ⚠

**22969** ..... 37  
 Passenger, Chrome Plated, rear only -0  
 ..... **\$400.00 EA** ⚠

**22975** ..... 37  
 Passenger Rear Chrome Plated -0  
 ..... **\$400.00 EA** ⚠

**1939 FORD SHOWN**



**22970** .....38-39  
 Passenger, Chrome Plated,and P/U Truck  
 front and rear (not for 39 Deluxe) -0  
 ..... **\$400.00 EA** ⚠

**Bumpers Chrome Ford, cont.**

**1939 FORD SHOWN**



**22971** ..... 39  
 Passenger - Deluxe Only, Chrome Plated,  
 front and rear -0 ..... **\$400.00 EA** ⚠

**22972** ..... 40  
 Passenger and Pickup, Chrome Plated,  
 front and rear and 40-41 Pick-Up Front -0  
 ..... **\$400.00 EA** ⚠

**22973** .....40-41  
 Pickup, Chrome Plated, rear -0  
 ..... **\$400.00 EA** ⚠

**22974** .....42-46  
 Passenger Front Chrome Plated -0  
 ..... **\$400.00 EA** ⚠

**Bumpers Stainless Ford**

**1939 FORD SHOWN**



**22976** ..... 37  
 Passenger - front only, Pickup - front and  
 rear stainless -0 ..... **\$460.00 EA** ⚠

**1939 FORD SHOWN**



**22977** .....38-39  
 Passenger, Chrome Plated, rear only -0  
 ..... **\$460.00 EA** ⚠

**1939 FORD SHOWN**



**22978** ..... 39  
 Passenger, Chrome Plated,and P/U Truck  
 front and rear (not for 39 Deluxe) -0  
 ..... **CALL** ⚠

**Bumpers Stainless Ford, cont.**

**22979** ..... 40  
 Passenger Car Deluxe only front and rear.  
 Stainless Polished smooth, no bolt holes,  
 stud mounted -0 ..... **\$460.00 EA** ⚠

**22980** .....40-41  
 Passenger Car - Front & Rear; & 40-41  
 Pickup - Front Polished Stainless, smooth,  
 no bolt holes, stud mounted -0  
 ..... **\$460.00 EA** ⚠

**22981** .....42-47  
 Pickup, Sedan Delivery and Station Wagon  
 - rear Polished Stainless, smooth, no bolt  
 holes, stud mounted -0 ..... **\$460.00 EA** ⚠

**22982** .....42-47  
 Pickup, Polished Stainless, front only,  
 smooth, no bolt holes, stud mounted -0  
 ..... **\$460.00 EA** ⚠

**22983** .....48-52  
 Pickup, Polished Stainless, front only (with  
 holes) -0 ..... **\$460.00 EA** ⚠

**22984** .....48-56  
 Pickup, Polished Stainless , front Correct  
 for 1948-50 - will fit 1951-52 -0  
 ..... **\$345.00 EA** ⚠

**22985** .....48-56  
 Pickup, Polished Stainless, Rear -0  
 ..... **\$345.00 EA** ⚠

**22986** .....53-56  
 Pickup, Polished Stainless, Front -0  
 ..... **\$345.00 EA** ⚠

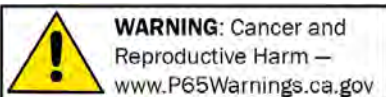

NOTE: Any chemicals will be shipped domestic ground only (Lower 48 states only). No international shipping.



**Bumpers - Nickel-Chrome Chevy Car (1-Piece)**

Oversized shipping charges applies on all bumpers. Please call for rates.



**3698600** .....**49-52**  
Nickel-Chrome Front, 1-piece. 7.831 -0.15  
..... **\$325.00 EA** ⚠



**3698604** .....**49-52**  
Nickel-Chrome Rear, 1-piece. 7.831 -0.15  
..... **\$325.00 EA** ⚠



**3697341** .....**53**  
Nickel-Chrome Front, 1-piece. Has bumper bolt holes and license plate mount holes. 7.831 -0.15  
..... **\$325.00 EA** ⚠



**3697689** .....**53-54**  
Nickel-Chrome Rear, 1-piece w/ bumper bolt holes. Passenger cars (exc Sedan delivery & Wagon). 7.831 -0.15  
..... **\$325.00 EA** ⚠



**3704531** .....**54**  
Nickel-Chrome Front, 1-piece. Has bumper bolt holes and license plate mount holes. 7.831 -0.15  
..... **\$325.00 EA** ⚠

**Bumper Brackets -Alloy**

Many alloy brackets available for custom applications. Please call for availability.



**BRACKETYFP-C** .....**47-54**  
Polished, "Y" style for 5 rib contoured front bumper, 47-54 Chevy Trucks. -0.15  
..... **\$275.75 L&R** ⚠



**BRACKETCRP** .....**ALL**  
Polished, "C" style, rear. -0.15  
..... **\$214.09 L&R** ⚠



**BRACKETJFP** .....**ALL**  
Polished, "J" style front. Call for your specific application. Fits BRIZ & other bumpers for most 37-54 Chevy trucks, 28-32 (some 33-36 & 46-57) Ford cars & most 28-56 Ford trucks. -0.15  
..... **\$214.09 L&R** ⚠

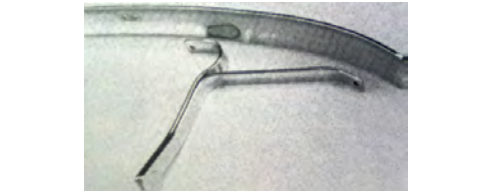

**BRACKETYFP** .....**ALL**  
Polished, "Y" style front. Call for your specific application. Fits BRIZ & other bumpers for 37-48 (some 35-36) Chevy cars, some 37-54 Chevy trucks, 37-41 (some 33-36) Ford cars & some 33-41 Ford trucks. -0.15  
..... **\$275.75 L&R** ⚠

**Bumper Brackets -Alloy, cont.**



**BRACKETYRP** .....**ALL**  
Polished, "Y" style rear. Call for your specific application. Fits BRIZ & other bumpers for 37-48 Chevy trucks, some 37-54 Chevy trucks, 37-41 Ford cars & some 33-41 Ford trucks. -0.15  
..... **\$275.75 L&R** ⚠

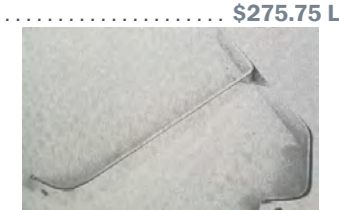

**BRACKETYSFP** .....**ALL**  
Polished, "Y" style "Shoebox" front. Call for your specific application. Fits BRIZ & other bumpers for most 49-53 Chevy cars & most 46-57 Ford cars. -0.15  
..... **\$275.75 L&R** ⚠



**BRACKETYSRP** .....**ALL**  
Polished, "Y" style "Shoebox" rear. Call for your specific application. Fits BRIZ & other bumpers for most 49-53 Chevy cars & most 46-57 Ford cars. -0.15  
..... **\$275.69 L&R** ⚠

**Roll Pans - Rear Chevy Truck**

Oversized shipping charges apply. Please call for rates.



**3658265P** .....**41-46**  
Steel pan. Rear with license plate recess. Replaces back bumper for smooth look. 7.831 -0.15  
..... **\$167.25 EA** ⚠

**23247100** .....**47-53**  
Bolt-on, smooth. 1-piece, 12ga. steel. Recess for license plate. Use with Pro's Pick tailgate only (order 4-piece roll pan for stock tailgates). -0.15  
..... **\$450.00 EA** ⚠

**Roll Pans - Rear Chevy Truck, cont.**



**3683305P** .....47-53  
Steel pan. Rear with license plate recess.  
Replaces back bumper for smooth look.  
7.831 -0.15 ..... **\$167.00 EA** ⚠



**3705437P** .....54-87  
Steel pan. Rear with license plate recess.  
Replaces back bumper for smooth look.  
Fits stepside only 7.831 -0.15  
..... **\$167.25 EA** ⚠

**License Plate Frame -Chevrolet**



**986710** .....37-54  
Year on top and "Chevrolet" on bottom of  
frame. Choose 1937-1954 (Exc 43-45).  
Specify year when ordering. (2 pcs). -  
Made For Modern Plates 9.777 -0  
.....starting at **\$18.50 SET** ⚠

**License Plate Frame -Ford**



**FAZ13421** .....37-64  
The year on top and "FORD" on bottom of  
frame. Choose 1937-1964 ( Except  
39,40,47) Specify year when ordering.  
Sold as two pieces. 9.777 -0.3  
.....starting at **\$20.00 SET** ⚠

**License Plate Light**

**LEDTL17** .....ALL  
4 super bright LED's,  
chrome housing, 2  
wires. -0.15  
..... **\$12.00 EA** ⚠



**PAN-11204** .....ALL  
LED Backup light  
and license plate light. Chrome, flush  
mount -0.15  
..... **\$33.75 EA** ⚠



**License Plate Toppers**



**FELIX** .....ALL  
Universal Felix the  
cat license frame  
ornament. -0.15  
..... **\$20.00 EA** ⚠



**PLATETOP48** .....ALL  
48 Star Flag -0  
..... **\$16.99 EA** ⚠



**PLATETOPCAT** .....ALL  
Cat with moving eyes  
and tongue. -0  
..... **\$16.99 EA** ⚠



**VPALPT007AB** ... .ALL  
Chrome Safety Star  
With Amber Led  
Illumination -0.15  
..... **\$43.95 EA** ⚠



**VPALPT007GN** ... .ALL  
Chrome Safety Star  
With Green Led  
Illumination -0  
..... **CALL** ⚠



**VPALPT007RD** ... .ALL  
Chrome Safety  
Star With Red Led  
Illumination -0.15  
..... **\$43.95 EA** ⚠



**VPALPT008** .....ALL  
Pegasus (Drive  
Safely) -0.15  
..... **\$16.99 EA** ⚠



**VPALPT017** .....ALL  
H-Bomb Plate  
Topper -0.15  
..... **\$35.00 EA** ⚠

**License Accessories**



**FLAG01** .....ALL  
License Plate Frame  
Accessory, U.S.A.  
Flag -0.4  
..... **\$2.75 EA** ⚠

**License Accessories, cont.**



**FLAG02** .....ALL  
Flag Holder - 5  
Post -0.15  
..... **\$6.75 EA** ⚠



**FLAG03** .....ALL  
Flag Holder-Chrome  
3 Post -0  
..... **CALL** ⚠

**License Plate Frame (Billet Specialties)**



**BIS55120** .....ALL  
Billet aluminum, smooth. 9.777 -0.15  
..... **\$30.75 EA** ⚠

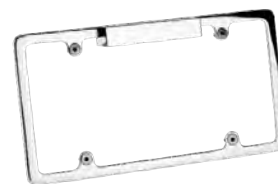

**BIS55220** .....ALL  
Billet aluminum, smooth with license light.  
9.777 -0 ..... **\$46.49 EA** ⚠

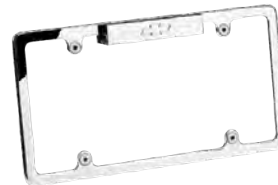

**BIS55320** .....ALL  
Billet aluminum with Chevy Bowtie &  
license light. 9.777 -0 ..... **\$55.79 EA** ⚠



**BIS55520** .....ALL  
Billet aluminum with license light and 3rd  
brake light. 9.777 -0.15 ..... **\$69.75 EA** ⚠

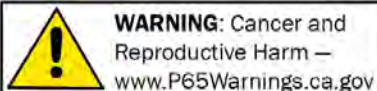

**WARNING:** Cancer and  
Reproductive Harm —  
www.P65Warnings.ca.gov

NOTE: Any chemicals will be shipped domestic ground only (Lower 48 states only). No international shipping.

**License Plate Frame (Billet Specialties), cont.**

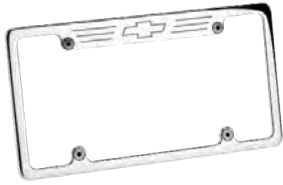

**BIS55623**.....ALL  
Billet aluminum with Chevy Bowtie.  
9.777 -0.15 ..... **\$35.50 EA** ⚠

**License Plate Frame**



**PAN-110203** .....ALL  
Chrome Flush Mount Led 3rd Brake  
Light -0 ..... **\$29.09 EA** ⚠



**PAN-39397**.....ALL  
License Plate Frame - Chrome With Split  
Turn Function 10 Red LED Lights and Red  
Lens -0.15 ..... **\$27.99 EA** ⚠



**PAN-39744**.....ALL  
Chrome license plate frame with 14 red  
LED lights behind a red lens. 12" long light  
bar. 12 Volt only -0.15 ..... **\$34.25 EA**  
⚠



**PAN-39748**.....ALL  
Chrome license plate frame with 14 red  
LED lights behind a chrome lens. 12" long  
light bar. 12 Volt only -0.15  
..... **\$38.75 EA** ⚠

**License Plate Frame, cont.**



**PAN-39884**.....ALL  
Chrome license plate frame with a Cats  
Eye Style Red 10 LED light with a red lens  
across the bottom. 12 Volt only -0.15  
..... **\$34.75 EA** ⚠



**PAN-S20007LED** .....ALL  
license plate and Led 3rd Brake light -0  
..... **\$32.89 EA** ⚠

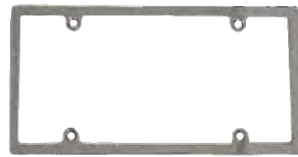

**R6070**.....ALL  
Chrome Aluminum License Frame without  
Light. -0.15 ..... **\$22.00 EA** ⚠



**R6071**.....ALL  
Chrome Aluminum License Frame with  
Light. -0.15 ..... **\$29.50 EA** ⚠



**R6270**.....ALL  
Chrome Aluminum with LED license light &  
LED 3rd brake light. -0.15  
..... **\$45.00 EA** ⚠

**License Plate Frame, cont.**



**R6271**.....ALL  
Chrome Aluminum License Plate Frame  
with Light & Third Brake Light. -0.15  
..... **\$69.19 EA** ⚠

**License Fastener**



**985096**.....37-64  
Chome Diamond, choose diamond color:  
clear, amber, red, green, blue, purple.  
9.777 -0.15 ..... **\$14.00 EA** ⚠



**985094**.....ALL  
Glass jewel reflector. Specify Red, Green,  
Blue, Amber, Burnt Orange, Purple, Clear,  
Light Blue, Yellow, Rainbow. (2 pcs).  
9.777 -0.2 ..... **starting at \$20.00 PR** ⚠

**985094P**.....ALL  
Plastic jewel reflector.  
Red (2 pcs). 9.777 -0.15  
..... **\$3.00 PR** ⚠



**LF70045**.....ALL  
8 Ball License Plate Fastener -0.15  
..... **\$4.39 PR** ⚠



**LF70065**.....ALL  
Lion Head License Plate Fastener -0.15  
..... **\$4.25 PR** ⚠

**License Fastener, cont.**



**LF70070.....ALL**  
 Chrome Dice License Plate Fastener -0.15  
 ..... **\$4.00 PR** ⚠



**LF70071.....ALL**  
 Chrome Bullet License Plate Fastener -0.15  
 ..... **\$6.00 PR** ⚠



**LF70072.....ALL**  
 Dice License Plate Fastener Green With  
 White Dots -0.15 ..... **\$3.99 PR** ⚠



**LF70073.....ALL**  
 Dice License Plate Fastener Purple With  
 White Dots -0.15 ..... **\$4.50 PR** ⚠



**LF70074.....ALL**  
 Large 8 Ball License Plate Fastener -0.15  
 ..... **\$5.89 PR** ⚠



**LF70096.....ALL**  
 Iron Cross License Plate Fastener -0.15  
 ..... **\$5.75 PR** ⚠

**License Fastener, cont.**



**LF70315.....ALL**  
 Chrome Skull License Plate Fastener -0.15  
 ..... **\$4.00 PR** ⚠

**Bolt Lights**



**BBOLTS.....ALL**  
 LED lighted stainless steel bolts for license  
 light or anywhere else you can use them. 2  
 bolt lights, wiring and instructions. -0.3  
 ..... **\$34.00 SET** ⚠

**1937 Chevy Car Grilles -Billet  
 Aluminum**

Note: Oversize shipping charges apply on all  
 Grilles. Please call for rates.

Note: Billet Aluminum Grilles take 6-12 weeks  
 for delivery.

**594624BNC..... 37**  
 Chromed bars, 1/4in. bar spacing. No  
 crank hole. 1.266-0 ..... **\$1,790.00 EA** ⚠

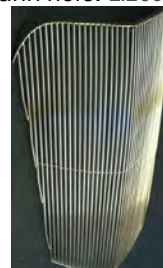

**594624BNF ... 37**  
 Polished (face of  
 bars only), 1/4in.  
 bar spacing. No  
 crank hole. 1.266-0  
 .... **\$1,075.00 EA** ⚠



**594624BNP ... 37**  
 Fully Polished,  
 1/4in. bar spacing.  
 No crank hole.  
 1.266-0  
 ... **\$1,295.00 EA** ⚠



**594624BWC... 37**  
 Chromed bars, stock  
 3/8in. bar spacing.  
 No crank hole.  
 1.266-0  
 ... **\$1,520.00 EA** ⚠



**594624BWF..... 37**  
 Polished (face of bars only), stock 3/8in.  
 bar spacing. No crank hole. 1.266-0  
 ..... **\$850.00 EA** ⚠

**594624BWP ..... 37**  
 Fully Polished, stock 3/8in. bar spacing.  
 No crank hole. 1.266-0 ..... **\$1,025.00 EA** ⚠

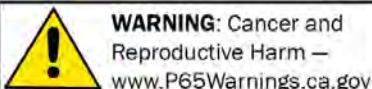

NOTE: Any chemicals will be shipped domestic ground only (Lower 48 states only). No international shipping.

**1937 Chevy Truck Grille -Billet Aluminum, cont.**



**595112BNC ... 37**  
 Chromed bars.  
 Narrow spacing  
 (1/4in. space).  
 1.266 -0  
 ... **\$1,826.00 EA** ⚠



**595112BNF ... 37**  
 Polished (front bars  
 only). Narrow bar  
 spacing (1/4in.  
 space). 1.266 -0  
 ... **\$1,075.00 EA** ⚠



**595112BNP ... 37**  
 Fully polished. Narrow bar spacing (1/4in.  
 space). 1.266 -0  
 ... **\$1,295.00 EA** ⚠

**595112BWC ... 37**  
 Chromed. Standard bar spacing (3/8in.  
 space). 1.266 -0  
 ... **\$1,520.00 EA** ⚠

**595112BWF ... 37**  
 Polished (front of bars only). Standard bar  
 spacing (3/8in. space). 1.266 -0  
 ... **\$850.00 EA** ⚠



**595112BWP ... 37**  
 Fully polished.  
 Standard bar  
 spacing (3/8in.  
 space). 1.266 -0  
 ... **\$1,025.00 EA** ⚠

**1937 Chevy Car Grilles -Stainless**



**594624SS ... 37**  
 POLISHED REPRO.  
 Has crank hole.  
 1.266 -0  
 ... **CALL** ⚠

**1937 Chevy Truck Grille -Stainless, cont.**



**595112S ... 37**  
 Stainless, like  
 original. 1.266 -0  
 ... **\$875.75 EA** ⚠

**1937 Chevy Car "Gangster Grille"**

**594624LP ... 37**  
 Plain steel, laser cut. No crank hole.  
 1.266 -0.15  
 ... **\$424.25 EA** ⚠



**594624LS ... 37**  
 Polished stainless,  
 laser cut. No crank  
 hole. 1.266 -0.15  
 ... **\$675.00 EA** ⚠

**1937 Chevy Truck "Gangster Grille"**

**595112LP ... 37**  
 Laser cut. Bare steel for street rod.  
 1.266 -0.15  
 ... **\$445.00 EA** ⚠



**595112LS ... 37**  
 Laser cut. Polished  
 stainless for street  
 rod. 1.266 -0.15  
 ... **\$675.00 EA** ⚠

**1937 Chevy Car Grille Center Strip**

**594722S ... 37**  
 Stainless steel. 1 piece, covers crank hole.  
 No hole for emblem. 1.268 -0.15  
 ... **\$116.00 EA** ⚠

**1937 Chevy Truck Grille Center Strip**

**594996S ... 37**  
 Street rod (no holes for emblem or crank).  
 1.268 -0.15  
 ... **\$100.25 EA** ⚠

**1937 Ford Car Grille -Billet Aluminum**

37 Ford grilles have rear spine TIG welded and gusset added for top plate/ hood latch support. Measures 22" across the top at rear. Note: Billet Aluminum Grilles take 6-12 weeks for delivery.



**ALGRILLEFCA ... 37**  
 Chromed Aluminum. -0  
 ... **\$2,395.00 EA** ⚠



**ALGRILLEFPFA . 37**  
 BILLET ALUMINUM,  
 POLISHED (FACE OF  
 BARS ONLY). -0  
 ... **\$2,200.00 EA** ⚠

**1938 Chevy Car Grille -Billet Aluminum**



**597529BNF ... 38**  
 1 piece bars,  
 polished on front  
 face only. No crank  
 hole. 1/4" bar  
 spacing. 1.266 -0  
 ... **\$2,195.00 EA** ⚠

**597529BWF ... 38**  
 1 piece bars, polished on front face only.  
 No crank hole. 3/8" bar spacing (wide).  
 1.266 -0  
 ... **\$2,195.00 EA** ⚠

**1938 Chevy Car "Gangster Grille"**



**597529LP ... 38**  
 Plain steel, laser cut.  
 Offset bar sizing.  
 No crank hole.  
 1.266 -0.15  
 ... **\$415.00 EA** ⚠

**1938 Chevy Car "Gangster Grille", cont.**



**597529LS** ..... 38  
 Polished stainless, laser cut. Offset bar sizing. No crank hole. 1.266 -0.15

..... **\$675.00 EA** ⚠

**597529LSM** ..... 38  
 Polished stainless, laser cut. Even bar sizing. No crank hole. 1.266 -0.15

..... **\$675.00 EA** ⚠

**1938 Chevy Truck "Gangster Grille"**



**597829LP** ..... 38

Laser cut. Bare steel for street rod.

1.266 -0.15  
 ..... **\$414.75 EA** ⚠

**597829LS** ..... 38

Laser cut. Polished stainless for street rod. 1.266 -0.15

..... **\$675.00 EA** ⚠

**1939 Grille -Chevy Billet**



**350339BC** ..... 39

Billet Grille for your '39 Chevy Car or Sedan Delivery. Beautiful chrome plated aluminum.

1.266 -0  
 ..... **CALL** ⚠



**350339BF** ..... 39

Billet aluminum grille for your '39 Chevy Car or Sedan Delivery. Beautiful polished face.

1.266 -0  
 ..... **CALL** ⚠



**350339BP** ..... 39

Billet aluminum grille for your '39 Chevy Car or Sedan Delivery. Beautifully fully polished.

1.266 -0  
 ..... **CALL** ⚠

**1939 Chevy Car "Gangster Grille"**



**350339LP** ..... 39

Plain steel, laser cut. No crank hole.

1.266 -0.15 ..... **\$360.00 EA** ⚠

**350339LS** ..... 39

Polished stainless, laser cut. No crank hole. 1.266 -0.15

..... **\$674.00 EA** ⚠

**1939 Chevy Car "Gangster Fender Grilles"**



**603837LS** ..... 39

Polished Stainless Steel, Laser Cut.

1.266 -0.15 ..... **\$164.75 L&R** ⚠

**1940 Chevy Car Grille -Billet Aluminum**



**3653525B** ..... 40

Billet Grille for your '40 Chevy Car or Sedan Delivery. Aluminum with polished face, powder coated back side to give it a one of a kind "floating" look. And you can only get it at Chevs of the 40's!

1.266 -0 ..... **CALL** ⚠

**1940 Chevy Car "Gangster Grille"**

**3653525LP** ..... 40

Bare steel. Laser cut. 1.266 -0.15

..... **\$545.00 EA** ⚠



**3653525LS** ..... 40

Polished stainless. Laser cut. 1.266 -0

..... **\$795.00 EA** ⚠

**1940 Ford Car Grille -Billet Aluminum**



**ALGRILLEFPA** ..... 40

Billet aluminum fully polished. -0

..... **\$1,495.00 EA** ⚠



**ALGRILLEFPFA** ..... 40

Billet aluminum w/ polished edges (face of bars). -0

..... **\$1,295.00 EA** ⚠

**1941 Chevy Car Grille -Billet Aluminum**



**3658060B** ..... 41

Billet aluminum with shaped ends makes mouldings optional. Polished face of bars, powdercoated backside. Includes mouting hardware. Fits cars & Sedan Delivery.

1.266 -0.15 ..... **\$1,797.00 EA** ⚠



**3658060B0** ..... 41

Billet aluminum with extended bars over fenders. Polished face of bars, powdercoated backside. The ends of the grille overlap the fender and eliminates the mouldings. Includes hardware. Fits cars & Sedan Delivery. 1.266 -0

..... **CALL** ⚠

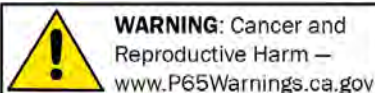

NOTE: Any chemicals will be shipped domestic ground only (Lower 48 states only). No international shipping.

**1947-53 Chevy Truck Grille**



**3847340C** .....47-53  
All chrome, front and rear.  
Pre-assembled very nice. 1.266 -0.15  
..... **\$500.00 EA** ⚠



**384734BA** .....47-53  
Billet aluminum for Chevy trucks with  
movable "Chevrolet" lettering.  
..... **\$1600.00 EA** ⚠

**3847340B** .....47-53  
Billet aluminum for Chevy trucks  
..... **\$1500.00 EA** ⚠

**1953-57 Corvette Grille**



**3706490** .....53-57  
Great look for a unique front end on your  
street rod. Order as original replacement  
for 53-57 Corvettes. Chrome, 13 teeth. 40  
inches overall length. 1.266 -0.15  
..... **\$569.00 EA** ⚠



**3706491** .....53-57  
Great look for a unique front end on your  
street rod. Chrome, 17 teeth. 50 inches  
overall length. 1.266 -0 ..... **\$825.00 EA** ⚠



**3706492** .....53-57  
Great look for a unique front end on your  
street rod. Chrome, 19 teeth. 55.5 inches  
overall length. 1.266 -0 ..... **\$875.00 EA** ⚠

**Grille Shell -Chevy Car**



**602608** ..... 37  
Fiberglass. 1.263 -0.15  
..... **\$445.00 EA** ⚠

**Grille Shell -Chevy Car, cont.**



**602953** ..... 38  
Fiberglass. 1.263 -0  
..... **CALL** ⚠

**Panel Below Grille -Chevy Car**

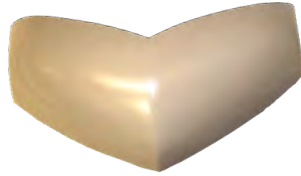

**593654** ..... 37  
Steel. 1.263 -0.15 ..... **\$95.25 EA** ⚠

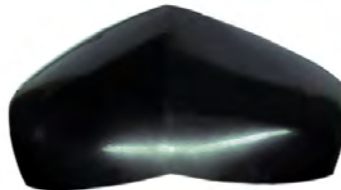

**593654F** ..... 37  
Fiberglass. 1.263 -0.15 .. **\$120.00 EA** ⚠



**603097** ..... 38  
Fiberglass. 1.263 -0 ..... **CALL** ⚠  
**350315** ..... 39  
Fiberglass. 1.263 -0.15  
..... **\$110.00 EA** ⚠



**3653401** ..... 40  
Fiberglass. 1.263 -0.15 .. **\$155.00 EA** ⚠



**3658214** ..... 41  
Fiberglass. 1.263 -0.15 .. **\$175.00 EA** ⚠

**Panel Below Grille -Chevy Truck**



**3680810** .....41-46  
Fiberglass. 1.266 -0.15 .... **\$90.25 EA** ⚠



**3680810S** .....41-46  
Fiberglass w/out bumper cutouts street  
rod application. 1.266 -0.15 .. **\$95.25 EA**  
⚠

**3680810SC** ..... 41-46  
Steel with bumper cutouts 1.266 -0  
..... **\$172.00 EA** ⚠



**3680810SM** .....41-46  
Steel w/out bumper cutouts street rod  
application. 1.266 -0 ..... **CALL** ⚠

**Panel Below Grille -GMC Truck**



**3680810G** .....41-46  
GMC fiberglass. 1.266 -0.15 .. **\$95.25 EA**  
⚠



**3680810GS** .....41-46  
GMC fiberglass w/out bumper cutouts  
street rod application. 1.266 -0.15  
..... **\$95.25 EA** ⚠

**1947-53 Grille - GMC**

**2227896C** .....47-53  
GMC. Chrome bars w/ cream background.  
Repro. 6.076 -0.15 ..... **\$616.00 EA** ⚠

**Hoods & Hood Sides -Chevy Car**

Note: Oversize shipping charges apply on all Hoods. Please call for rates.

**602565F** ..... **37**  
Hood sides, smooth.  
8.001-0  
..... **CALL** ⚠



**602565FS** ..... **37**  
Hood sides w/ recessed scoop. 8.001-0  
..... **CALL** ⚠



**602971F** ..... **38**  
1 piece top section. 8.000-0  
..... **CALL** ⚠



**602973F** ..... **38**  
Hood sides, smooth. 8.001-0  
..... **CALL** ⚠



**602973FS** ..... **38**  
Hood sides w/ recessed scoop. 8.001-0  
..... **CALL** ⚠



**603359FT** ..... **39**  
1 piece top section. 8.002-0  
..... **CALL** ⚠

**Grille Shell -Chevy Car**



**603360F** ..... **39**  
Hood Sides Smooth. 8.002-0  
..... **CALL** ⚠



**3651109F** ..... **40**  
Upper rear left. 8.153-0  
..... **CALL** ⚠  
**3653110F** ..... **40**  
Upper rear right. 8.153-0  
..... **CALL** ⚠  
**3653889F** ..... **40**  
1 piece top section.  
8.000-0  
..... **CALL** ⚠

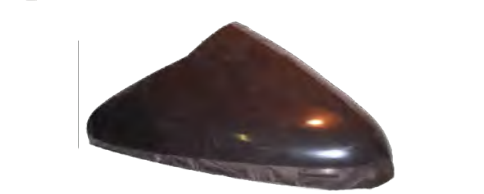
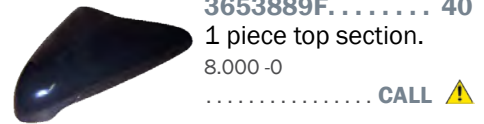

**3657895F** ..... **41**  
Fiberglass Hood 8.000-0  
..... **CALL** ⚠

**Hoods & Hood Sides -Chevy Truck**

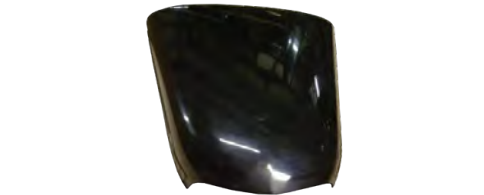

**602345F** ..... **37**  
1-piece top section. 8.001-0  
..... **CALL** ⚠  
**602346F** ..... **37**  
Hood sides, smooth 8.001-0  
..... **CALL** ⚠



**602346FS** ..... **37**  
Hood sides, original style. 8.001-0  
..... **CALL** ⚠

**Hoods & Hood Sides -Chevy Truck, cont.**



**602985F** ..... **38**  
1-piece top section. 8.001-0  
..... **CALL** ⚠  
**602986F** ..... **38**  
Hood sides, smooth. 8.001-0  
..... **CALL** ⚠



**605189F** ..... **41-46**  
Fiberglass. 1 piece top 8.000-0  
..... **CALL** ⚠



**3701466F** ..... **47-55**  
1-piece top section. 8.000-0  
..... **CALL** ⚠

**Under Hood Insulation Covers - Chevrolet**

Under Hood Cover Kits for insulating your engine compartment and dressing up the underside of the hood of popular Ford, General Motors and MOPAR cars and trucks. Smooth Under Hood Covers are available for car and truck restorations. 3-D molded Under Hood Covers feature vehicle brand names and logos in raised letters and graphics. Every hood cover kit is pre-cut and ready to install and are Officially Licensed Products.



**22213** ..... **47-54**  
1947-54 Chevrolet Truck Under Hood Cover with CEID-265 AcoustiHood Kit -0.15  
..... **\$239.00** ⚠  
**22214** ..... **47-54**  
1947-54 Chevrolet Truck Under Hood Cover with CEID-283 AcoustiHood Kit -0.15  
..... **\$239.00** ⚠

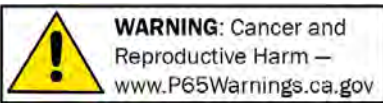

NOTE: Any chemicals will be shipped domestic ground only (Lower 48 states only). No international shipping.



**Under Hood Insulation Covers - Chevrolet, cont.**

22215.....	47-54
1947-54 Chevrolet Truck Under Hood Cover with CEID-305 AcoustiHood Kit -0.15 ..... \$239.00 ⚠	
22216.....	47-54
1947-54 Chevrolet Truck Under Hood Cover with CEID-327 AcoustiHood Kit -0.15 ..... \$239.00 ⚠	
22217.....	47-54
1947-54 Chevrolet Truck Under Hood Cover with CEID-350 AcoustiHood Kit -0.15 ..... \$239.00 ⚠	
22218.....	47-54
1947-54 Chevrolet Truck Under Hood Cover with CEID-383 AcoustiHood Kit -0.15 ..... \$239.00 ⚠	
22219.....	47-54
1947-54 Chevrolet Truck Under Hood Cover with CEID-396 AcoustiHood Kit -0.15 ..... \$239.00 ⚠	
22220.....	47-54
1947-54 Chevrolet Truck Under Hood Cover with CEID-427 AcoustiHood Kit -0.15 ..... \$239.00 ⚠	
22221.....	47-54
1947-54 Chevrolet Truck Under Hood Cover with CEID-454 AcoustiHood Kit -0.15 ..... \$239.00 ⚠	
22222.....	47-54
1947-54 Chevrolet Truck Under Hood Cover-with G-009 Bowtie Chev AcoustiHood Kit -0.15 .... \$239.00 ⚠	
22223.....	47-54
1947-54 Chevrolet Truck AcoustiHood Cover Kit-Smooth -0.15 .. \$178.39 ⚠	
22224.....	49-52
1949-52 Chevrolet Car AcoustiHood Cover Kit-Smooth -0.15 .. \$169.00 ⚠	
22225.....	49-52
1949-52 Chevrolet Car Under Hood Cover with CEID-265 AcoustiHood Kit -0.15 ..... \$239.00 ⚠	
22226.....	49-52
1949-52 Chevrolet Car Under Hood Cover with CEID-283 AcoustiHood Kit -0.15 ..... \$239.00 ⚠	
22227.....	49-52
1949-52 Chevrolet Car Under Hood Cover with CEID-305 AcoustiHood Kit -0.15 ..... \$239.00 ⚠	
22228.....	49-52
1949-52 Chevrolet Car Under Hood Cover with CEID-327 AcoustiHood Kit -0.15 ..... \$239.00 ⚠	
22229.....	49-52
1949-52 Chevrolet Car Under Hood Cover with CEID-350 AcoustiHood Kit -0.15 ..... \$239.00 ⚠	

**Under Hood Insulation Covers - Chevrolet, cont.**

22230.....	49-52
1949-52 Chevrolet Car Under Hood Cover with CEID-383 AcoustiHood Kit -0.15 ..... \$239.00 ⚠	
22231.....	49-52
1949-52 Chevrolet Car Under Hood Cover with CEID-396 AcoustiHood Kit -0.15 ..... \$239.00 ⚠	
22232.....	49-52
1949-52 Chevrolet Car Under Hood Cover with CEID-427 AcoustiHood Kit -0.15 ..... \$239.00 ⚠	
22233.....	49-52
1949-52 Chevrolet Car Under Hood Cover with CEID-454 AcoustiHood Kit -0.15 ..... \$239.00 ⚠	
22234.....	49-52
1949-52 Chevrolet Car Under Hood Cover-with G-010 Chev Bowtie AcoustiHood Kit -0.15 .... \$239.00 ⚠	
22235.....	49-52
1949-52 Chevrolet Car Under Hood Cover-with G-096 Chev Crest AcoustiHood Kit -0.15 ..... \$239.00 ⚠	
22236.....	53-54
1953-54 Chevrolet AcoustiHood Cover Kit-Smooth -0.15 ..... \$169.00 ⚠	
22237.....	53-54
1953-54 Chevrolet Under Hood Cover with CEID-265 AcoustiHood Kit -0.15 ..... \$239.00 ⚠	
22238.....	53-54
1953-54 Chevrolet Under Hood Cover with CEID-283 AcoustiHood Kit -0.15 ..... \$239.00 ⚠	
22239.....	53-54
1953-54 Chevrolet Under Hood Cover with CEID-305 AcoustiHood Kit -0.15 ..... \$239.00 ⚠	
22240.....	53-54
1953-54 Chevrolet Under Hood Cover with CEID-327 AcoustiHood Kit -0.15 ..... \$239.00 ⚠	
22241.....	53-54
1953-54 Chevrolet Under Hood Cover with CEID-350 AcoustiHood Kit -0.15 ..... \$239.00 ⚠	
22242.....	53-54
1953-54 Chevrolet Under Hood Cover with CEID-383 AcoustiHood Kit -0.15 ..... \$239.00 ⚠	
22243.....	53-54
1953-54 Chevrolet Under Hood Cover with CEID-396 AcoustiHood Kit -0.15 ..... \$239.00 ⚠	
22244.....	53-54
1953-54 Chevrolet Under Hood Cover with CEID-427 AcoustiHood Kit -0.15 ..... \$239.00 ⚠	

**Under Hood Insulation Covers - Chevrolet, cont.**

22245.....	53-54
1953-54 Chevrolet Under Hood Cover with CEID-454 AcoustiHood Kit -0.15 ..... \$239.00 ⚠	
22246.....	53-54
1953-54 Chevrolet Under Hood Cover-with G-010 Chev Bowtie AcoustiHood Kit -0.15 ..... \$239.00 ⚠	
22247.....	53-54
1953-54 Chevrolet Under Hood Cover-with G-096 Chev Crest AcoustiHood Kit -0.15 ..... \$239.00 ⚠	
22248.....	55-56
1955-56 Chevrolet Under Hood Cover-Smooth, -0.15 ..... \$169.00 ⚠	
22249.....	55-56
1955-56 Chevrolet Under Hood Cover with CEID-265 AcoustiHood Kit -0.15 ..... \$239.00 ⚠	
22250.....	55-56
1955-56 Chevrolet Under Hood Cover with CEID-283 AcoustiHood Kit -0.15 ..... \$239.00 ⚠	
22251.....	55-56
1955-56 Chevrolet Under Hood Cover with CEID-305 AcoustiHood Kit -0.15 ..... \$239.00 ⚠	
22252.....	55-56
1955-56 Chevrolet Under Hood Cover with CEID-327 AcoustiHood Kit -0.15 ..... \$239.00 ⚠	
22253.....	55-56
1955-56 Chevrolet Under Hood Cover with CEID-350 AcoustiHood Kit -0.15 ..... \$239.00 ⚠	
22254.....	55-56
1955-56 Chevrolet Under Hood Cover with CEID-383 AcoustiHood Kit -0.15 ..... \$239.00 ⚠	
22255.....	55-56
1955-56 Chevrolet Under Hood Cover with CEID-396 AcoustiHood Kit -0.15 ..... \$239.00 ⚠	
22256.....	55-56
1955-56 Chevrolet Under Hood Cover with CEID-427 AcoustiHood Kit -0.15 ..... \$239.00 ⚠	
22257.....	55-56
1955-56 Chevrolet Under Hood Cover with CEID-454 AcoustiHood Kit -0.15 ..... \$239.00 ⚠	
22258.....	55-56
1955-56 Chevrolet Under Hood Cover-with G-010 Chev Bowtie AcoustiHood Kit -0.15 ..... \$239.00 ⚠	
22259.....	55-56
1955-56 Chevrolet Under Hood Cover-with G-013 Chev Wing AcoustiHood Kit -0.15 ..... \$239.00 ⚠	

Returns require a return authorization number—Please call first. • Note: Product pricing and availability subject to change.



**Under Hood Insulation Covers - Chevrolet, cont.**

22260.....	55-56
1955-56 Chevrolet Under Hood Cover with G-016 Belair Wing AcoustiHood Kit -0.15 ..... \$239.00 ⚠	
22261.....	55-56
1955-56 Chevrolet Under Hood Cover with G-066 Belair Crest AcoustiHood Kit -0.15 ..... \$239.00 ⚠	
22262.....	55-56
1955-56 Chevrolet Under Hood Cover with G-083 Nomad Wing AcoustiHood Kit -0.15 ..... \$239.00 ⚠	
22263.....	55-59
1955-59 Chevrolet Truck AcoustiHood Cover Kit-Smooth -0.15 .. \$169.00 ⚠	
22264.....	55-59
1955-59 Chevrolet Truck Under Hood Cover with CEID-265 AcoustiHood Kit -0.15 ..... \$239.00 ⚠	
22265.....	55-59
1955-59 Chevrolet Truck Under Hood Cover with CEID-283 AcoustiHood Kit -0.15 ..... \$239.00 ⚠	
22266.....	55-59
1955-59 Chevrolet Truck Under Hood Cover with CEID-305 AcoustiHood Kit -0.15 ..... \$239.00 ⚠	
22267.....	55-59
1955-59 Chevrolet Truck Under Hood Cover with CEID-327 AcoustiHood Kit -0.15 ..... \$239.00 ⚠	
22268.....	55-59
1955-59 Chevrolet Truck Under Hood Cover with CEID-350 AcoustiHood Kit -0.15 ..... \$239.00 ⚠	
22269.....	55-59
1955-59 Chevrolet Truck Under Hood Cover with CEID-383 AcoustiHood Kit -0.15 ..... \$239.00 ⚠	
22270.....	55-59
1955-59 Chevrolet Truck Under Hood Cover with CEID-396 AcoustiHood Kit -0.15 ..... \$239.00 ⚠	
22271.....	55-59
1955-59 Chevrolet Truck Under Hood Cover with CEID-427 AcoustiHood Kit -0.15 ..... \$239.00 ⚠	
22272.....	55-59
1955-59 Chevrolet Truck Under Hood Cover with CEID-454 AcoustiHood Kit -0.15 ..... \$239.00 ⚠	
22273.....	55-59
1955-59 Chevrolet Truck Under Hood Cover-with G-009 Bowtie Chev AcoustiHood Kit -0.15 .... \$239.00 ⚠	
22274.....	57
1957 Chevrolet Car AcoustiHood Cover Kit-Smooth -0.15 ..... \$169.00 ⚠	

**Under Hood Insulation Covers - Chevrolet, cont.**

22275.....	57
1957 Chevrolet Car Under Hood Cover with CEID-265 AcoustiHood Kit -0.15 ..... \$239.00 ⚠	
22276.....	57
1957 Chevrolet Car Under Hood Cover with CEID-283 AcoustiHood Kit -0.15 ..... \$239.00 ⚠	
22277.....	57
1957 Chevrolet Car Under Hood Cover with CEID-305 AcoustiHood Kit -0.15 ..... \$239.00 ⚠	
22278.....	57
1957 Chevrolet Car Under Hood Cover with CEID-327 AcoustiHood Kit -0.15 ..... \$239.00 ⚠	
22279.....	57
1957 Chevrolet Car Under Hood Cover with CEID-350 AcoustiHood Kit -0.15 ..... \$239.00 ⚠	
22280.....	57
1957 Chevrolet Car Under Hood Cover with CEID-383 AcoustiHood Kit -0.15 ..... \$239.00 ⚠	
22281.....	57
1957 Chevrolet Car Under Hood Cover with CEID-396 AcoustiHood Kit -0.15 ..... \$239.00 ⚠	
22282.....	57
1957 Chevrolet Car Under Hood Cover with CEID-427 AcoustiHood Kit -0.15 ..... \$239.00 ⚠	
22283.....	57
1957 Chevrolet Car Under Hood Cover with G-010 Chev Bowtie AcoustiHood Kit -0.15 ..... \$239.00 ⚠	
22284.....	57
1957 Chevrolet Car Under Hood Cover with G-013 Chev Wing AcoustiHood Kit -0.15 ..... \$239.00 ⚠	
22285.....	57
1957 Chevrolet Car Under Hood Cover with G-016 Belair Wing AcoustiHood Kit -0.15 ..... \$239.00 ⚠	
22286.....	57
1957 Chevrolet Car Under Hood Cover with G-083 Nomad Wing AcoustiHood Kit -0.15 ..... \$239.00 ⚠	
22287.....	58
1958 Chevrolet AcoustiHood Cover Kit-Smooth -0.15 ..... \$149.00 ⚠	
22288.....	58
1958 Chevrolet Under Hood Cover with CEID-265 AcoustiHood Kit -0.15 ..... \$239.00 ⚠	
22289.....	58
1958 Chevrolet Under Hood Cover with CEID-283 AcoustiHood Kit -0.15 ..... \$239.00 ⚠	

**Under Hood Insulation Covers - Chevrolet, cont.**

22290.....	58
1958 Chevrolet Under Hood Cover with CEID-305 AcoustiHood Kit -0.15 ..... \$239.00 ⚠	
22291.....	58
1958 Chevrolet Under Hood Cover with CEID-327 AcoustiHood Kit -0.15 ..... \$239.00 ⚠	
22292.....	58
1958 Chevrolet Under Hood Cover with CEID-350 AcoustiHood Kit -0.15 ..... \$239.00 ⚠	
22293.....	58
1958 Chevrolet Under Hood Cover with CEID-383 AcoustiHood Kit -0.15 ..... \$239.00 ⚠	
22294.....	58
1958 Chevrolet Under Hood Cover with CEID-396 AcoustiHood Kit -0.15 ..... \$239.00 ⚠	
22295.....	58
1958 Chevrolet Under Hood Cover with CEID-427 AcoustiHood Kit -0.15 ..... \$239.00 ⚠	
22296.....	58
1958 Chevrolet Under Hood Cover-with G-010 Chev Bowtie AcoustiHood Kit -0.15 ..... \$239.00 ⚠	
22297.....	58
1958 Chevrolet Under Hood Cover-with G-016 Belair Wing AcoustiHood Kit -0.15 ..... \$239.00 ⚠	
22298.....	58
1958 Chevrolet Under Hood Cover-with G-042 Impala AcoustiHood Kit -0.15 ..... \$239.00 ⚠	
22299.....	58
1958 Chevrolet Under Hood Cover-with G-083 Nomad Wing AcoustiHood Kit -0.15 ..... \$239.00 ⚠	
22300.....	58
1958 Chevrolet Under Hood Cover-with G-124 Delray Wing AcoustiHood Kit -0.15 ..... \$239.00 ⚠	
22301.....	58
1958 Chevrolet Under Hood Cover-with G-127 Impala Wing AcoustiHood Kit -0.15 ..... \$239.00 ⚠	
22302.....	59-60
1959-60 Chevrolet AcoustiHood Cover Kit-Smooth -0.15 ..... \$169.00 ⚠	
22303.....	59-60
1959-60 Chevrolet Under Hood Cover with CEID-265 AcoustiHood Kit -0.15 ..... \$239.00 ⚠	
22304.....	59-60
1959-60 Chevrolet Under Hood Cover with CEID-283 AcoustiHood Kit -0.15 ..... \$239.00 ⚠	

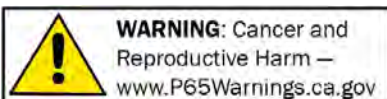

NOTE: Any chemicals will be shipped domestic ground only (Lower 48 states only). No international shipping.

**Under Hood Insulation Covers - Chevrolet, cont.**

22305.....	59-60	
1959-60 Chevrolet Under Hood Cover with CEID-305 AcoustiHood Kit -0.15		\$239.00 ⚠
22306.....	59-60	
1959-60 Chevrolet Under Hood Cover with CEID-327 AcoustiHood Kit -0.15		\$239.00 ⚠
22307.....	59-60	
1959-60 Chevrolet Under Hood Cover with CEID-350 AcoustiHood Kit -0.15		\$239.00 ⚠
22308.....	59-60	
1959-60 Chevrolet Under Hood Cover with CEID-383 AcoustiHood Kit -0.15		\$239.00 ⚠
22309.....	59-60	
1959-60 Chevrolet Under Hood Cover with CEID-396 AcoustiHood Kit -0.15		\$239.00 ⚠
22310.....	59-60	
1959-60 Chevrolet Under Hood Cover with CEID-427 AcoustiHood Kit -0.15		\$239.00 ⚠
22311.....	59-60	
1959-60 Chevrolet Under Hood Cover with CEID-454 AcoustiHood Kit -0.15		\$239.00 ⚠
22312.....	59-60	
1959-60 Chevrolet Under Hood Cover with G-010 Chev Bowtie AcoustiHood Kit -0.15		\$239.00 ⚠
22313.....	59-60	
1959-60 Chevrolet Under Hood Cover with G-013 Chev Wing AcoustiHood Kit -0.15		\$239.00 ⚠
22314.....	59-60	
1959-60 Chevrolet Under Hood Cover with G-016 Belair Wing AcoustiHood Kit -0.15		\$239.00 ⚠
22315.....	59-60	
1959-60 Chevrolet Under Hood Cover with G-042 Impala AcoustiHood Kit -0.15		\$239.00 ⚠
22316.....	59-60	
1959-60 Chevrolet Under Hood Cover with G-083 Nomad Wing AcoustiHood Kit -0.15		\$239.00 ⚠
22317.....	59-60	
1959-60 Chevrolet Under Hood Cover with G-127 Impala Wing AcoustiHood Kit -0.15		\$239.00 ⚠
22318.....	59-60	
1959-60 El Camino A-Body Under Hood Cover-Smooth -0.15		\$169.00 ⚠
22319.....	59-60	
1959-60 El Camino A-Body Under Hood Cover with CEID-265 -0.15		\$239.00 ⚠

**Under Hood Insulation Covers - Chevrolet, cont.**

22320.....	59-60	
1959-60 El Camino A-Body Under Hood Cover with CEID-283 -0.15		\$239.00 ⚠
22321.....	59-60	
1959-60 El Camino A-Body Under Hood Cover with CEID-305 -0.15		\$239.00 ⚠
22322.....	59-60	
1959-60 El Camino A-Body Under Hood Cover with CEID-327 -0.15		\$239.00 ⚠
22323.....	59-60	
1959-60 El Camino A-Body Under Hood Cover with CEID-350 -0.15		\$239.00 ⚠
22324.....	59-60	
1959-60 El Camino A-Body Under Hood Cover with CEID-383 -0.15		\$239.00 ⚠
22325.....	59-60	
1959-60 El Camino A-Body Under Hood Cover with CEID-396 -0.15		\$239.00 ⚠
22326.....	59-60	
1959-60 El Camino A-Body Under Hood Cover with CEID-427 -0.15		\$239.00 ⚠
22327.....	59-60	
1959-60 El Camino A-Body Under Hood Cover with CEID-454 -0.15		\$239.00 ⚠
22328.....	59-60	
1959-60 El Camino A-Body Under Hood Cover with G-003 ElCamino -0.15		\$239.00 ⚠
22329.....	59-60	
1959-60 El Camino Under Hood Cover with G-SS396 -0.15		\$239.00 ⚠
22330.....	59-60	
1959-60 El Camino Under Hood Cover with G-SS396BE El Camino SS396 -0.15		\$239.00 ⚠
22331.....	59-60	
1959-60 El Camino Under Hood Cover with G-SS427 -0.15		\$239.00 ⚠
22332.....	59-60	
1959-60 El Camino Under Hood Cover with G-SS427BE El Camino SS427 -0.15		\$239.00 ⚠
22333.....	59-60	
1959-60 El Camino Under Hood Cover with G-SS454 -0.15		\$239.00 ⚠
22334.....	59-60	
1959-60 El Camino Under Hood Cover with G-SS454BE El Camino SS427 -0.15		\$239.00 ⚠
22335.....	60-66	
1955-59 Chevrolet Truck AcoustiHood Cover Kit-Smooth -0.15		\$189.00 ⚠

**Under Hood Insulation Covers - Chevrolet, cont.**

22336.....	60-66	
1960-66 Chevrolet Truck Under Hood Cover with CEID-265 AcoustiHood Kit -0.15		\$259.00 ⚠
22337.....	60-66	
1960-66 Chevrolet Truck Under Hood Cover with CEID-283 AcoustiHood Kit -0.15		\$259.00 ⚠
22338.....	60-66	
1960-66 Chevrolet Truck Under Hood Cover with CEID-305 AcoustiHood Kit -0.15		\$259.00 ⚠
22339.....	60-66	
1960-66 Chevrolet Truck Under Hood Cover with CEID-327 AcoustiHood Kit -0.15		\$259.00 ⚠
22340.....	60-66	
1960-66 Chevrolet Truck Under Hood Cover with CEID-350 AcoustiHood Kit -0.15		\$259.00 ⚠
22341.....	60-66	
1960-66 Chevrolet Truck Under Hood Cover with CEID-383 AcoustiHood Kit -0.15		\$259.00 ⚠
22342.....	60-66	
1960-66 Chevrolet Truck Under Hood Cover with CEID-396 AcoustiHood Kit -0.15		\$259.00 ⚠
22343.....	60-66	
1960-66 Chevrolet Truck Under Hood Cover with CEID-427 AcoustiHood Kit -0.15		\$259.00 ⚠
22344.....	60-66	
1960-66 Chevrolet Truck Under Hood Cover with CEID-454 AcoustiHood Kit -0.15		\$259.00 ⚠
22345.....	60-66	
1955-59 Chevrolet Truck Under Hood Cover with G-010 Bowtie Chev AcoustiHood Kit -0.15		\$259.00 ⚠
22346.....	61-62	
1961-62 Chevrolet AcoustiHood Cover Kit-Smooth -0.15		\$169.00 ⚠
22347.....	61-62	
1961-62 Chevrolet Car Under Hood Cover with CEID-265 AcoustiHood Kit -0.15		\$239.00 ⚠
22348.....	61-62	
1961-62 Chevrolet Car Under Hood Cover with CEID-283 AcoustiHood Kit -0.15		\$239.00 ⚠
22349.....	61-62	
1961-62 Chevrolet Car Under Hood Cover with CEID-305 AcoustiHood Kit -0.15		\$239.00 ⚠
22350.....	61-62	
1961-62 Chevrolet Car Under Hood Cover with CEID-327 AcoustiHood Kit -0.15		\$239.00 ⚠

Returns require a return authorization number—Please call first. • Note: Product pricing and availability subject to change.

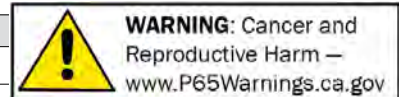

**Under Hood Insulation Covers - Chevrolet, cont.**

22351.....	61-62
1961-62 Chevrolet Car Under Hood Cover with CEID-350 AcoustiHood Kit -0.15	
.....	<b>\$239.00</b> ⚠
22352.....	61-62
1961-62 Chevrolet Car Under Hood Cover with CEID-383 AcoustiHood Kit -0.15	
.....	<b>\$239.00</b> ⚠
22353.....	61-62
1961-62 Chevrolet Car Under Hood Cover with CEID-396 AcoustiHood Kit -0.15	
.....	<b>\$239.00</b> ⚠
22354.....	61-62
1961-62 Chevrolet Car Under Hood Cover with CEID-427 AcoustiHood Kit -0.15	
.....	<b>\$239.00</b> ⚠
22356.....	61-62
1961-62 Chevrolet Car Under Hood Cover with CEID-454 AcoustiHood Kit -0.15	
.....	<b>\$239.00</b> ⚠
22357.....	61-62
1961-62 Chevrolet Car Under Hood Cover with G-010 Chev Bowtie AcoustiHood Kit -0.15	
.....	<b>\$239.00</b> ⚠
22358.....	61-62
1961-62 Chevrolet Car Under Hood Cover with G-013 Chev Wing AcoustiHood Kit -0.15	
.....	<b>\$239.00</b> ⚠
22359.....	61-62
1961-62 Chevrolet Car Under Hood Cover with G-016 BelAir Wing AcoustiHood Kit -0.15	
.....	<b>\$239.00</b> ⚠
22360.....	61-62
1961-62 Chevrolet Car Under Hood Cover with G-037 SS/Impala Circle Logo. AcoustiHood Kit -0.15	
.....	<b>\$239.00</b> ⚠
22361.....	61-62
1961-62 Chevrolet Car Under Hood Cover with G-042 Impala AcoustiHood Kit -0.15	
.....	<b>\$239.00</b> ⚠
22362.....	61-62
1961-62 Chevrolet Car Under Hood Cover with G-127 Impala Wing AcoustiHood Kit -0.15	
.....	<b>\$239.00</b> ⚠
22363.....	63-64
1963-64 Chevrolet AcoustiHood Cover Kit-Smooth -0.15	
.....	<b>\$169.00</b> ⚠
22364.....	63-64
1963-64 Chevrolet Under Hood Cover with CEID-265 AcoustiHood Kit -0.15	
.....	<b>\$239.00</b> ⚠
22365.....	63-64
1963-64 Chevrolet Under Hood Cover with CEID-283 AcoustiHood Kit -0.15	
.....	<b>\$239.00</b> ⚠
22366.....	63-64
1963-64 Chevrolet Under Hood Cover with CEID-305 AcoustiHood Kit -0.15	
.....	<b>\$239.00</b> ⚠

**Under Hood Insulation Covers - Chevrolet, cont.**

22367.....	63-64
1963-64 Chevrolet Under Hood Cover with CEID-327 AcoustiHood Kit -0.15	
.....	<b>\$239.00</b> ⚠
22368.....	63-64
1961-62 Chevrolet Under Hood Cover with CEID-350 AcoustiHood Kit -0.15	
.....	<b>\$239.00</b> ⚠
22369.....	63-64
1963-64 Chevrolet Under Hood Cover with CEID-383 AcoustiHood Kit -0.15	
.....	<b>\$239.00</b> ⚠
22370.....	63-64
1963-64 Chevrolet Under Hood Cover with CEID-396 AcoustiHood Kit -0.15	
.....	<b>\$239.00</b> ⚠
22371.....	63-64
1963-64 Chevrolet Under Hood Cover with CEID-427 AcoustiHood Kit -0.15	
.....	<b>\$239.00</b> ⚠
22372.....	63-64
1963-64 Chevrolet Under Hood Cover with CEID-454 AcoustiHood Kit -0.15	
.....	<b>\$239.00</b> ⚠
22373.....	63-64
1963-64 Chevrolet Under Hood Cover with G-010 Chev Bowtie AcoustiHood Kit -0.15	
.....	<b>\$239.00</b> ⚠
22374.....	63-64
1963-64 Chevrolet Under Hood Cover with G-013 Chev Wing AcoustiHood Kit -0.15	
.....	<b>\$239.00</b> ⚠
22375.....	63-64
1963-64 Chevrolet Under Hood Cover with G-016 Belair Wing AcoustiHood Kit -0.15	
.....	<b>\$239.00</b> ⚠
22376.....	63-64
1963-64 Chevrolet Under Hood Cover with G-042 Impala AcoustiHood Kit -0.15	
.....	<b>\$239.00</b> ⚠
22377.....	63-64
1963-64 Chevrolet Under Hood Cover with G-127 Impala Wing AcoustiHood Kit -0.15	
.....	<b>\$239.00</b> ⚠
22378.....	63-64
1963-64 Chevrolet Under Hood Cover with G-SS396 SS-396 -0.15	
.....	<b>\$239.00</b> ⚠
22379.....	63-64
1963-64 Chevrolet Under Hood Cover with G-SS396B Chev SS396 -0.15	
.....	<b>\$239.00</b> ⚠
22380.....	63-64
1963-64 Chevrolet Under Hood Cover with G-SS427 SS-427 -0.15	
.....	<b>\$239.00</b> ⚠
22381.....	63-64
1963-64 Chevrolet Under Hood Cover with G-SS427B Chev SS427 -0.15	
.....	<b>\$239.00</b> ⚠

**Under Hood Insulation Covers - Chevrolet, cont.**

22382.....	63-64
1963-64 Chevrolet Under Hood Cover with G-SS454 SS-454 -0.15	
.....	<b>\$239.00</b> ⚠
22383.....	63-64
1963-64 Chevrolet Under Hood Cover with G-SS454B Chev SS454 -0.15	
.....	<b>\$239.00</b> ⚠

**Under Hood Insulation Covers - Dodge**

Under Hood Cover Kits for insulating your engine compartment and dressing up the underside of the hood of popular Ford, General Motors and MOPAR cars and trucks. Smooth Under Hood Covers are available for car and truck restorations. 3-D molded Under Hood Covers feature vehicle brand names and logos in raised letters and graphics. Every hood cover kit is pre-cut and ready to install and are Officially Licensed Products.



22384.....	48-53
1948-53 Dodge Truck AcoustiHood Cover Kit-Smooth -0.15	
.....	<b>\$176.00</b> ⚠
22385.....	48-53
1948-53 Dodge Truck Under Hood Cover with M-095 Dodge AcoustiHood Kit -0.15	
.....	<b>\$249.00</b> ⚠
22386.....	48-53
1948-53 Dodge Truck Under Hood Cover with MEID-318 Magnum V8 AcoustiHood Kit -0.15	
.....	<b>\$249.00</b> ⚠
22387.....	48-53
1948-53 Dodge Truck Under Hood Cover with MEID-360 Magnum V8 AcoustiHood Kit -0.15	
.....	<b>\$249.00</b> ⚠
22388.....	48-53
1948-53 Dodge Truck Under Hood Cover with MEID-383 Magnum V8 AcoustiHood Kit -0.15	
.....	<b>\$249.00</b> ⚠
22389.....	48-53
1948-53 Dodge Truck Under Hood Cover with MEID-440 Magnum V8 AcoustiHood Kit -0.15	
.....	<b>\$249.00</b> ⚠
22390.....	55-56
1955-56 Dodge Truck AcoustiHood Cover Kit-Smooth -0.15	
.....	<b>\$176.00</b> ⚠
22391.....	55-56
1955-56 Dodge Truck Under Hood Cover with M-095 Dodge AcoustiHood Kit -0.15	
.....	<b>\$249.00</b> ⚠

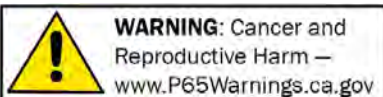

NOTE: Any chemicals will be shipped domestic ground only (Lower 48 states only). No international shipping.

**Under Hood Insulation Covers - Dodge, cont.**

22392.....	55-56
1955-56 Dodge Truck Under Hood Cover-with MEID-318 Magnum V8 AcoustiHood Kit -0.15 .... \$249.00 ⚠	
22393.....	55-56
1955-56 Dodge Truck Under Hood Cover-with MEID-360 Magnum V8 AcoustiHood Kit -0.15 .... \$249.00 ⚠	
22394.....	55-56
1955-56 Dodge Truck Under Hood Cover-with MEID-383 Magnum V8 AcoustiHood Kit -0.15 .... \$249.00 ⚠	
22395.....	55-56
1955-56 Dodge Truck Under Hood Cover-with MEID-440 Magnum V8 AcoustiHood Kit -0.15 .... \$249.00 ⚠	
22396.....	57-59
1957-59 Dodge Truck SweepSide Under Hood Cover-Smooth -0.15 \$176.00 ⚠	
22397.....	57-59
1957-59 Dodge Truck SweepSide Under Hood Cover-with M-062 Dodge 100 AcoustiHood Kit -0.15 .... \$249.00 ⚠	
22398.....	57-59
1957-59 Dodge Truck SweepSide Under Hood Cover-with MEID-318 Magnum V8 AcoustiHood Kit -0.15 .... \$249.00 ⚠	
22399.....	57-59
1957-59 Dodge Truck SweepSide Under Hood Cover-with MEID-360 Magnum V8 AcoustiHood Kit -0.15 .... \$249.00 ⚠	
22400.....	57-59
1957-59 Dodge Truck SweepSide Under Hood Cover-with MEID-383 Magnum V8 AcoustiHood Kit -0.15 .... \$249.00 ⚠	
22401.....	57-59
1957-59 Dodge Truck SweepSide Under Hood Cover-with MEID-440 Magnum V8 AcoustiHood Kit -0.15 .... \$249.00 ⚠	
22402.....	57-60
1957-60 Dodge Truck AcoustiHood Cover Kit-Smooth -0.15 .... \$176.00 ⚠	
22403.....	57-60
1957-60 Dodge Truck Under Hood Cover-with M-095 Dodge AcoustiHood Kit -0.15 .... \$249.00 ⚠	
22404.....	57-60
1957-60 Dodge Truck Under Hood Cover-with MEID-318 Magnum V8 AcoustiHood Kit -0.15 .... \$249.00 ⚠	
22405.....	57-60
1957-60 Dodge Truck Under Hood Cover-with MEID-360 Magnum AcoustiHood Kit -0.15 .... \$249.00 ⚠	
22406.....	57-60
1957-60 Dodge Truck Under Hood Cover-with MEID-383 Magnum V8 AcoustiHood Kit -0.15 .... \$249.00 ⚠	

**Under Hood Insulation Covers - Dodge, cont.**

22407.....	57-60
1957-60 Dodge Truck Under Hood Cover-with MEID-440 Magnum V8 AcoustiHood Kit -0.15 .... \$249.00 ⚠	
<b>Under Hood Insulation Covers - Ford</b>	
Under Hood Cover Kits for insulating your engine compartment and dressing up the underside of the hood of popular Ford, General Motors and MOPAR cars and trucks. Smooth Under Hood Covers are available for car and truck restorations. 3-D molded Under Hood Covers feature vehicle brand names and logos in raised letters and graphics. Every hood cover kit is pre-cut and ready to install and are Officially Licensed Products.	
22446.....	48-52
1948-52 Ford Truck F-1 AcoustiHood Cover Kit-Smooth -0.15 .. \$169.00 ⚠	
22447.....	48-52
1948-52 Ford Truck F-1 Under Hood Cover-with F-003 Ford AcoustiHood Kit -0.15 .... \$239.00 ⚠	
22448.....	48-52
1948-52 Ford Truck Under Hood Cover with FEID-260R AcoustiHood Kit -0.15 .... \$239.00 ⚠	
22449.....	48-52
1948-52 Ford Truck Under Hood Cover with FEID-289R AcoustiHood Kit -0.15 .... \$239.00 ⚠	
22450.....	48-52
1948-52 Ford Truck Under Hood Cover with FEID-302R AcoustiHood Kit -0.15 .... \$239.00 ⚠	
22451.....	48-52
1948-52 Ford Truck Under Hood Cover with FEID-351R AcoustiHood Kit -0.15 .... \$239.00 ⚠	
22452.....	48-52
1948-52 Ford Truck Under Hood Cover with FEID-390R AcoustiHood Kit -0.15 .... \$239.00 ⚠	
22453.....	48-52
1948-52 Ford Truck Under Hood Cover with FEID-428R AcoustiHood Kit -0.15 .... \$239.00 ⚠	
22454.....	48-52
1948-52 Ford Truck Under Hood Cover with FEID-429R AcoustiHood Kit -0.15 .... \$239.00 ⚠	
22455.....	53-55
1953-55 Ford Truck F-100 AcoustiHood Cover Kit-Smooth -0.15 .. \$169.00 ⚠	
22456.....	53-55
1953-55 Ford Truck F-100 Under Hood Cover-with F-001 Ford Script Logo AcoustiHood Kit -0.15 .... \$239.00 ⚠	

**Under Hood Insulation Covers - Ford, cont.**

22457.....	53-55
1953-55 Ford Truck F-100 Under Hood Cover-with F-044 Ford F-100 AcoustiHood Kit -0.15 .... \$239.00 ⚠	
22458.....	53-55
1953-55 Ford Truck Under Hood Cover with FEID-260R AcoustiHood Kit -0.15 .... \$239.00 ⚠	
22459.....	53-55
1953-55 Ford Truck Under Hood Cover with FEID-289R AcoustiHood Kit -0.15 .... \$239.00 ⚠	
22460.....	53-55
1953-55 Ford Truck Under Hood Cover with FEID-302R AcoustiHood Kit -0.15 .... \$239.00 ⚠	
22461.....	53-55
1953-55 Ford Truck Under Hood Cover with FEID-351R AcoustiHood Kit -0.15 .... \$239.00 ⚠	
22462.....	53-55
1953-55 Ford Truck Under Hood Cover with FEID-390R AcoustiHood Kit -0.15 .... \$239.00 ⚠	
22463.....	53-55
1953-55 Ford Truck Under Hood Cover with FEID-428R AcoustiHood Kit -0.15 .... \$239.00 ⚠	
22464.....	53-55
1953-55 Ford Truck Under Hood Cover with FEID-429R AcoustiHood Kit -0.15 .... \$239.00 ⚠	
22465.....	56
1956 Ford Truck F-100 AcoustiHood Cover Kit-Smooth -0.15 .. \$169.00 ⚠	
22466.....	56
1956 Ford Truck F-100 Under Hood Cover-with F-044 Ford F-100 AcoustiHood Kit -0.15 .... \$239.00 ⚠	
22467.....	56
1956 Ford Truck Under Hood Cover with FEID-260R AcoustiHood Kit -0.15 .... \$239.00 ⚠	
22468.....	56
1956 Ford Truck Under Hood Cover with FEID-289R AcoustiHood Kit -0.15 .... \$239.00 ⚠	
22469.....	56
1956 Ford Truck Under Hood Cover with FEID-302R AcoustiHood Kit -0.15 .... \$239.00 ⚠	
22470.....	56
1956 Ford Truck Under Hood Cover with FEID-351R AcoustiHood Kit -0.15 .... \$239.00 ⚠	
22471.....	56
1956 Ford Truck Under Hood Cover with FEID-390R AcoustiHood Kit -0.15 .... \$239.00 ⚠	

Returns require a return authorization number—Please call first. • Note: Product pricing and availability subject to change.

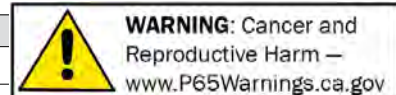

**Under Hood Insulation Covers - Ford, cont.**

22472.....	56
1956 Ford Truck Under Hood Cover with FEID-428R AcoustiHood Kit -0.15	
.....	\$239.00 ⚠
22473.....	56
1956 Ford Truck Under Hood Cover with FEID-429R AcoustiHood Kit -0.15	
.....	\$239.00 ⚠
22474.....	57
1957 Ford Car AcoustiHood Cover Kit-Smooth -0.15	
.....	\$169.00 ⚠
22475.....	57
1957 Ford Car Under Hood Cover-with F-045 Ford Fairlane 500 AcoustiHood Kit -0.15	
.....	\$239.00 ⚠
22476.....	57
1957 Ford Car Under Hood Cover with FEIDC-260 -0.15	
.....	\$239.00 ⚠
22477.....	57
1957 Ford Car Under Hood Cover with FEIDC-289 -0.15	
.....	\$239.00 ⚠
22478.....	57
1957 Ford Car Under Hood Cover with FEIDC-302 -0.15	
.....	\$239.00 ⚠
22479.....	57
1957 Ford Car Under Hood Cover with FEIDC-351 -0.15	
.....	\$239.00 ⚠
22480.....	57
1957 Ford Car Under Hood Cover with FEIDC-390 -0.15	
.....	\$239.00 ⚠
22481.....	57
1957 Ford Car Under Hood Cover with FEIDC-427 -0.15	
.....	\$239.00 ⚠
22482.....	57
1957 Ford Car Under Hood Cover with FEIDC-428 -0.15	
.....	\$239.00 ⚠
22483.....	57
1957 Ford Car Under Hood Cover with FEIDC-429 -0.15	
.....	\$239.00 ⚠
22484.....	57
1957 Ford Car Under Hood Cover with FEID-SOHC -0.15	
.....	\$239.00 ⚠
22485.....	57-58
1957-58 Ford Truck F-100 Under Hood Cover-Smooth -0.15	
.....	\$169.00 ⚠
22486.....	57-58
1957-58 Ford Truck Under Hood Cover with F-003 Ford Oval -0.15	
.....	\$239.00 ⚠
22487.....	57-58
1957-58 Ford Truck F-100 Under Hood Cover-with F-005 FORD Block -0.15	
.....	\$239.00 ⚠
22488.....	57-58
1957-58 Ford Truck Under Hood Cover with FEID-260R -0.15	
.....	\$239.00 ⚠
22489.....	57-58
1957-58 Ford Truck Under Hood Cover with FEID-289R -0.15	
.....	\$239.00 ⚠

**Under Hood Insulation Covers - Ford, cont.**

22490.....	57-58
1957-58 Ford Truck Under Hood Cover with FEID-302R -0.15	
.....	\$239.00 ⚠
22491.....	57-58
1957-58 Ford Truck Under Hood Cover with FEID-351R -0.15	
.....	\$239.00 ⚠
22492.....	57-58
1957-58 Ford Truck Under Hood Cover with FEID-390R -0.15	
.....	\$239.00 ⚠
22493.....	57-58
1957-58 Ford Truck Under Hood Cover with FEID-428R -0.15	
.....	\$239.00 ⚠
22494.....	57-58
1957-58 Ford Truck Under Hood Cover with FEID-429R -0.15	
.....	\$239.00 ⚠
22495.....	58
1958 Ford Car AcoustiHood Cover Kit-Smooth -0.15	
.....	\$169.00 ⚠
22496.....	58
1958 Ford Car Under Hood Cover-with F-045 Ford Fairlane 500 AcoustiHood Kit -0.15	
.....	\$239.00 ⚠
22497.....	58
1958 Ford Car Under Hood Cover with FEIDC-260 -0.15	
.....	\$239.00 ⚠
22498.....	58
1958 Ford Car Under Hood Cover with FEIDC-289 -0.15	
.....	\$239.00 ⚠
22499.....	58
1958 Ford Car Under Hood Cover with FEIDC-302 -0.15	
.....	\$239.00 ⚠
22500.....	58
1958 Ford Car Under Hood Cover with FEIDC-351 -0.15	
.....	\$239.00 ⚠
22501.....	58
1958 Ford Car Under Hood Cover with FEIDC-390 -0.15	
.....	\$239.00 ⚠
22502.....	58
1958 Ford Car Under Hood Cover with FEIDC-427 -0.15	
.....	\$239.00 ⚠
22503.....	58
1958 Ford Car Under Hood Cover with FEIDC-428 -0.15	
.....	\$239.00 ⚠
22504.....	58
1958 Ford Car Under Hood Cover with FEIDC-429 -0.15	
.....	\$239.00 ⚠
22505.....	58
1958 Ford Car Under Hood Cover with FEID-SOHC -0.15	
.....	\$239.00 ⚠
22506.....	59
1959 Ford Car AcoustiHood Cover Kit-Smooth -0.15	
.....	\$169.00 ⚠
22507.....	59
1959 Ford Car Under Hood Cover-with F-050 Ford Fairlane AcoustiHood Kit -0.15	
.....	\$239.00 ⚠
22508.....	59
1959 Ford Car Under Hood Cover-with F-076 Ford Galaxie AcoustiHood Kit -0.15	
.....	\$239.00 ⚠

**Under Hood Insulation Covers - Ford, cont.**

22509.....	59
1959 Ford Car Under Hood Cover with FEIDC-260 AcoustiHood Kit -0.15	
.....	\$239.00 ⚠
22510.....	59
1959 Ford Car Under Hood Cover with FEIDC-289 AcoustiHood Kit -0.15	
.....	\$239.00 ⚠
22511.....	59
1959 Ford Car Under Hood Cover with FEIDC-302 AcoustiHood Kit -0.15	
.....	\$239.00 ⚠
22512.....	59
1959 Ford Car Under Hood Cover with FEIDC-351 AcoustiHood Kit -0.15	
.....	\$239.00 ⚠
22513.....	59
1959 Ford Car Under Hood Cover with FEIDC-390 AcoustiHood Kit -0.15	
.....	\$239.00 ⚠
22514.....	59
1959 Ford Car Under Hood Cover with FEIDC-427 AcoustiHood Kit -0.15	
.....	\$239.00 ⚠
22515.....	59
1959 Ford Car Under Hood Cover with FEIDC-428 AcoustiHood Kit -0.15	
.....	\$239.00 ⚠
22516.....	59
1959 Ford Car Under Hood Cover with FEIDC-429 AcoustiHood Kit -0.15	
.....	\$239.00 ⚠
22517.....	59
1959 Ford Car Under Hood Cover with FEIDC-SOHC AcoustiHood Kit -0.15	
.....	\$239.00 ⚠
22518.....	59
1959 Ford Ranchero Under Hood Cover-Smooth AcoustiHood Kit -0.15	
.....	\$169.00 ⚠
22519.....	59
1959 Ford Ranchero Under Hood Cover-with F-047 Ford Ranchero AcoustiHood Kit -0.15	
.....	\$239.00 ⚠
22520.....	59
1959 Ford Ranchero Under Hood Cover with FEIDC-260 AcoustiHood Kit -0.15	
.....	\$239.00 ⚠
22521.....	59
1959 Ford Ranchero Under Hood Cover with FEIDC-289 AcoustiHood Kit -0.15	
.....	\$239.00 ⚠
22522.....	59
1959 Ford Ranchero Under Hood Cover with FEIDC-302 AcoustiHood Kit -0.15	
.....	\$239.00 ⚠
22523.....	59
1959 Ford Ranchero Under Hood Cover with FEIDC-351 AcoustiHood Kit -0.15	
.....	\$239.00 ⚠

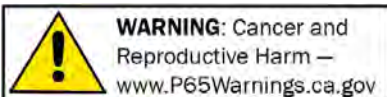

NOTE: Any chemicals will be shipped domestic ground only (Lower 48 states only). No international shipping.

**Under Hood Insulation Covers - Ford, cont.**

22524.....	59	1959 Ford Ranchero Under Hood Cover with FEIDC-390 AcoustiHood Kit -0.15	\$239.00	⚠
22525.....	59	1959 Ford Ranchero Under Hood Cover with FEIDC-427 AcoustiHood Kit -0.15	\$239.00	⚠
22526.....	59	1959 Ford Ranchero Under Hood Cover with FEIDC-428 AcoustiHood Kit -0.15	\$239.00	⚠
22527.....	59	1959 Ford Ranchero Under Hood Cover with FEIDC-428 AcoustiHood Kit -0.15	\$239.00	⚠
22528.....	59	1959 Ford Ranchero Under Hood Cover with FEIDC-SOHC AcoustiHood Kit -0.15	\$239.00	⚠
22529.....	59-60	1959-60 Ford Truck F-100 Under Hood Cover-Smooth -0.15	\$169.00	⚠
22530.....	59-60	1959-60 Ford Truck Under Hood Cover with F-003 Ford Oval -0.15	\$239.00	⚠
22531.....	59-60	1959-60 Ford Truck F-100 Under Hood Cover-with F-005 FORD Block -0.15	\$239.00	⚠
22532.....	59-60	1959-60 Ford Truck Under Hood Cover with FEID-260R -0.15	\$239.00	⚠
22533.....	59-60	1959-60 Ford Truck Under Hood Cover with FEID-289R -0.15	\$239.00	⚠
22534.....	59-60	1959-60 Ford Truck Under Hood Cover with FEID-302R -0.15	\$239.00	⚠
22535.....	59-60	1959-60 Ford Truck Under Hood Cover with FEID-351R -0.15	\$239.00	⚠
22536.....	59-60	1959-60 Ford Truck Under Hood Cover with FEID-390R -0.15	\$239.00	⚠
22537.....	59-60	1959-60 Ford Truck Under Hood Cover with FEID-428R -0.15	\$239.00	⚠
22538.....	59-60	1959-60 Ford Truck Under Hood Cover with FEID-429R -0.15	\$239.00	⚠
22539.....	60-62	1960-62 Ford Car Under Hood Cover-Smooth AcoustiHood Kit -0.15	\$169.00	⚠
22540.....	60-62	1960-62 Ford Car Under Hood Cover-with F-054 Starliner AcoustiHood Kit -0.15	\$239.00	⚠

**Under Hood Insulation Covers - Ford, cont.**

22541.....	60-62	1960-62 Ford Car Under Hood Cover-F-065 Galaxie Crest AcoustiHood Kit -0.15	\$239.00	⚠
22542.....	60-62	1960-62 Ford Car Under Hood Cover with FEIDC-260 AcoustiHood Kit -0.15	\$239.00	⚠
22543.....	60-62	1960-62 Ford Car Under Hood Cover with FEIDC-289 AcoustiHood Kit -0.15	\$239.00	⚠
22544.....	60-62	1960-62 Ford Car Under Hood Cover with FEIDC-302 AcoustiHood Kit -0.15	\$239.00	⚠
22545.....	60-62	1960-62 Ford Car Under Hood Cover with FEIDC-351 AcoustiHood Kit -0.15	\$239.00	⚠
22546.....	60-62	1960-62 Ford Car Under Hood Cover with FEIDC-390 AcoustiHood Kit -0.15	\$239.00	⚠
22547.....	60-62	1960-62 Ford Car Under Hood Cover with FEIDC-427 AcoustiHood Kit -0.15	\$239.00	⚠
22548.....	60-62	1960-62 Ford Car Under Hood Cover with FEIDC-428 AcoustiHood Kit -0.15	\$239.00	⚠
22549.....	60-62	1960-62 Ford Car Under Hood Cover with FEIDC-429 AcoustiHood Kit -0.15	\$239.00	⚠
22550.....	60-62	1960-62 Ford Car Under Hood Cover with FEID-SOHC AcoustiHood Kit -0.15	\$239.00	⚠
22419.....	60-63	1960-63 Falcon AcoustiHood Cover Kit-Smooth -0.15	\$169.00	⚠
22420.....	60-63	1960-63 Falcon Under Hood Cover-with F-042 Futura Bird AcoustiHood Kit -0.15	\$239.00	⚠
22421.....	60-63	1960-63 Falcon Under Hood Cover-with F-049 Sprint AcoustiHood Kit -0.15	\$239.00	⚠
22422.....	60-63	1960-63 Falcon Under Hood Cover-with F-053 Futura Script AcoustiHood Kit -0.15	\$239.00	⚠
22423.....	60-63	1960-63 Falcon Under Hood Cover-with F-057 Falcon Arrow AcoustiHood Kit -0.15	\$239.00	⚠

**Under Hood Insulation Covers - Ford, cont.**

22424.....	60-63	1960-63 Falcon Under Hood Cover with FEIDC-260 AcoustiHood Kit -0.15	\$239.00	⚠
22425.....	60-63	1960-63 Falcon Under Hood Cover with FEIDC-289 AcoustiHood Kit -0.15	\$239.00	⚠
22426.....	60-63	1960-63 Falcon Under Hood Cover with FEIDC-302 AcoustiHood Kit -0.15	\$239.00	⚠
22427.....	60-63	1960-63 Falcon Under Hood Cover with FEIDC-351 AcoustiHood Kit -0.15	\$239.00	⚠
22428.....	60-63	1960-63 Falcon Under Hood Cover with FEIDC-390 AcoustiHood Kit -0.15	\$239.00	⚠
22429.....	60-63	1960-63 Falcon Under Hood Cover with FEIDC-427 AcoustiHood Kit -0.15	\$239.00	⚠
22430.....	60-63	1960-63 Falcon Under Hood Cover with FEIDC-428 AcoustiHood Kit -0.15	\$239.00	⚠
22431.....	60-63	1960-63 Falcon Under Hood Cover with FEIDC-429 AcoustiHood Kit -0.15	\$239.00	⚠
22432.....	60-63	1960-63 Falcon Under Hood Cover with FEIDC-SOHC AcoustiHood Kit -0.15	\$239.00	⚠
22551.....	61-64	1961-64 Ford Truck F-100 AcoustiHood Cover Kit-Smooth -0.15	\$189.00	⚠
22552.....	61-64	1961-64 Ford Truck F-100 Under Hood Cover-with F-005 FORD Block AcoustiHood Kit -0.15	\$259.00	⚠
22553.....	61-64	1961-64 Ford Truck Under Hood Cover with FEID-260R AcoustiHood Kit -0.15	\$259.00	⚠
22554.....	61-64	1961-64 Ford Truck Under Hood Cover with FEID-289R AcoustiHood Kit -0.15	\$259.00	⚠
22555.....	61-64	1961-64 Ford Truck Under Hood Cover with FEID-302R AcoustiHood Kit -0.15	\$259.00	⚠
22556.....	61-64	1961-64 Ford Truck Under Hood Cover with FEID-351R AcoustiHood Kit -0.15	\$259.00	⚠

Returns require a return authorization number—Please call first. • Note: Product pricing and availability subject to change.

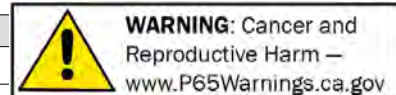

**Under Hood Insulation Covers - Ford, cont.**

- 22557..... 61-64  
1961-64 Ford Truck Under Hood Cover with FEID-390R AcoustiHood Kit -0.15  
..... \$259.00 ⚠
- 22558..... 61-64  
1961-64 Ford Truck Under Hood Cover with FEID-428R AcoustiHood Kit -0.15  
..... \$259.00 ⚠
- 22559..... 61-64  
1961-64 Ford Truck Under Hood Cover with FEID-429R AcoustiHood Kit -0.15  
..... \$259.00 ⚠



- 22408.....62-65  
1962-1965 Fairlane Under Hood Cover-Smooth -0.15 ..... \$169.00 ⚠
- 22409..... 62-65  
1962-65 Fairlane Under Hood Cover-with F-045 Fairlane 500 AcoustiHood Kit -0.15  
..... \$239.00 ⚠
- 22410..... 62-65  
1962-65 Fairlane Under Hood Cover with FEIDC-260 AcoustiHood Kit -0.15  
..... \$239.00 ⚠
- 22411..... 62-65  
1962-65 Fairlane Under Hood Cover with FEIDC-289 AcoustiHood Kit -0.15  
..... \$239.00 ⚠
- 22412..... 62-65  
1962-65 Fairlane Under Hood Cover with FEIDC-302 AcoustiHood Kit -0.15  
..... \$239.00 ⚠
- 22413..... 62-65  
1962-65 Fairlane Under Hood Cover with FEIDC-351 AcoustiHood Kit -0.15  
..... \$239.00 ⚠
- 22414..... 62-65  
1962-65 Fairlane Under Hood Cover with FEIDC-390 AcoustiHood Kit -0.15  
..... \$239.00 ⚠
- 22415..... 62-65  
1962-65 Fairlane Under Hood Cover with FEIDC-427 AcoustiHood Kit -0.15  
..... \$239.00 ⚠
- 22416..... 62-65  
1962-65 Fairlane Under Hood Cover with FEIDC-428 AcoustiHood Kit -0.15  
..... \$239.00 ⚠
- 22417..... 62-65  
1962-65 Fairlane Under Hood Cover with FEIDC-429 AcoustiHood Kit -0.15  
..... \$239.00 ⚠

**Under Hood Insulation Covers - Ford, cont.**

- 22418..... 62-65  
1962-65 Fairlane Under Hood Cover with FEIDC-SOHC AcoustiHood Kit -0.15  
..... \$239.00 ⚠
- 22560..... 63-64  
1963-64 Car Ford AcoustiHood Cover Kit-Smooth -0.15 ..... \$169.00 ⚠
- 22561..... 63-64  
1963-64 Car Ford Under Hood Cover-with F-065 Galaxie Crest AcoustiHood Kit -0.15  
..... \$239.00 ⚠
- 22562..... 63-64  
1963-64 Car Ford Under Hood Cover with FEIDC-260 AcoustiHood Kit -0.15  
..... \$239.00 ⚠
- 22563..... 63-64  
1963-64 Car Ford Under Hood Cover with FEIDC-289 AcoustiHood Kit -0.15  
..... \$239.00 ⚠
- 22564..... 63-64  
1963-64 Car Ford Under Hood Cover with FEIDC-302 AcoustiHood Kit -0.15  
..... \$239.00 ⚠
- 22565..... 63-64  
1963-64 Car Ford Under Hood Cover with FEIDC-351 AcoustiHood Kit -0.15  
..... \$239.00 ⚠
- 22566..... 63-64  
1963-64 Car Ford Under Hood Cover with FEIDC-390 AcoustiHood Kit -0.15  
..... \$239.00 ⚠
- 22567..... 63-64  
1963-64 Car Ford Under Hood Cover with FEIDC-427 AcoustiHood Kit -0.15  
..... \$239.00 ⚠
- 22568..... 63-64  
1963-64 Car Ford Under Hood Cover with FEIDC-428 AcoustiHood Kit -0.15  
..... \$239.00 ⚠
- 22569..... 63-64  
1963-64 Car Ford Under Hood Cover with FEIDC-429 AcoustiHood Kit -0.15  
..... \$239.00 ⚠
- 22570..... 63-64  
1963-64 Car Ford Under Hood Cover with FEIDC-SOHC AcoustiHood Kit -0.15  
..... \$239.00 ⚠
- 22433..... 64-65  
1964-65 Falcon Under Hood Cover-Smooth AcoustiHood Kit -0.15  
..... \$169.00 ⚠
- 22434..... 64-65  
1964-65 Falcon Under Hood Cover- F-042 Falcon Bird AcoustiHood Kit -0.15  
..... \$239.00 ⚠
- 22435..... 64-65  
1964-65 Falcon Under Hood Cover- F-043 Falcon Arrow AcoustiHood Kit -0.15  
..... \$239.00 ⚠

**Under Hood Insulation Covers - Ford, cont.**

- 22436..... 64-65  
1964-65 Falcon Under Hood Cover- F-049 Falcon Sprint AcoustiHood Kit -0.15  
..... \$239.00 ⚠
- 22437..... 64-65  
1964-65 Falcon Under Hood Cover with FEIDC-260 AcoustiHood Kit -0.15  
..... \$239.00 ⚠
- 22438..... 64-65  
1964-65 Falcon Under Hood Cover with FEIDC-289 AcoustiHood Kit -0.15  
..... \$239.00 ⚠
- 22439..... 64-65  
1964-65 Falcon Under Hood Cover with FEIDC-302 AcoustiHood Kit -0.15  
..... \$239.00 ⚠
- 22440..... 64-65  
1964-65 Falcon Under Hood Cover with FEIDC-351 AcoustiHood Kit -0.15  
..... \$239.00 ⚠
- 22441..... 64-65  
1964-65 Falcon Under Hood Cover with FEIDC-390 AcoustiHood Kit -0.15  
..... \$239.00 ⚠
- 22442..... 64-65  
1964-65 Falcon Under Hood Cover with FEIDC-427 AcoustiHood Kit -0.15  
..... \$239.00 ⚠
- 22443..... 64-65  
1964-65 Falcon Under Hood Cover with FEIDC-428 AcoustiHood Kit -0.15  
..... \$239.00 ⚠
- 22444..... 64-65  
1964-65 Falcon Under Hood Cover with FEIDC-429 AcoustiHood Kit -0.15  
..... \$239.00 ⚠
- 22445..... 64-65  
1964-65 Falcon Under Hood Cover with FEIDC-SOHC AcoustiHood Kit -0.15  
..... \$239.00 ⚠

**Hood Pin Set**



**R4052.....ALL**  
Chrome Replacement Hair Pin - Left/Right Side (Package of 2). -0

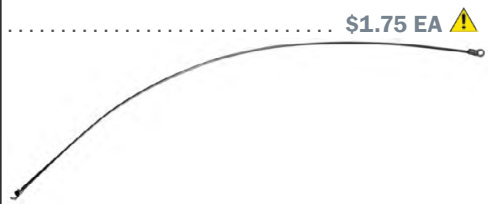

**R4054.....ALL**  
Chrome Replacement 24" Plastic Covered Lanyard (Package of 2). -0.15  
..... \$3.00 PR ⚠

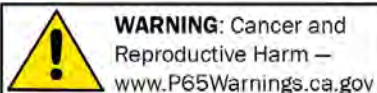

NOTE: Any chemicals will be shipped domestic ground only (Lower 48 states only). No international shipping.



**Hood Pin Set, cont.**



**R4056**.....ALL  
 Chrome 3/16" Torsion Pin Style Hood Pin Set. -0.15 ..... **\$7.79 EA** ⚠️



**R4058**.....ALL  
 Chrome Scruff Plate (Package of 2). -0.15 ..... **\$1.75 PR** ⚠️



**R4094**.....ALL  
 Chrome Hair Pin Style Hood Pin Set with Lanyards. -0.15 ..... **\$9.00 EA** ⚠️



**R4097**.....ALL  
 Chrome Replacement 3/16" Flip-Over Pin (Package of 2). -0.15 ..... **\$2.00 PR** ⚠️

**Hood Lock Set**



**R4062**.....ALL  
 Stainless, universal set. -0.15 ..... **\$17.00 EA** ⚠️

**Power Reverse Hood Kit**



**13004**.....ALL  
 At the touch of a button the Reverse Hood Kit is designed to lift up, move forward and open in reverse. While

traditional reverse opening hoods are manually operated and often require major valence clearance, Electric-Life's kit utilizes power actuators and a patent pending cam lever design to move the hood out of the way of any valence or front body paneling. Smooth operation is guaranteed with gas shock stabilizers and rear hood machined Delrin axial guideway.

Note: Use 13004B for mounting brackets (sold separately) -0

..... **\$1,328.25 SET** ⚠️  
**13004B**.....ALL

Universal mounting brackets can be used to install the 13004 on most vehicles. The bracket kit requires good fabricating and welding skills. -0 .. **\$287.50 SET** ⚠️

**Tilt Hood Hinge Kit**



**TILTHD**.....ALL  
 Kit makes it easy to reverse the tilt on your hood! Not only does it give you a custom look, it also allows for easy access and maximum visibility! Easy installation, universal application. High Strength Black Finish. Adjustable kit ships with detailed instructions. -0.15 .... **\$250.50 KIT** ⚠️

**Hood Hinge Kits**



**602564**.....37-39  
 Front Tilting, for use with Chevy fiberglass hood. 8.000 -0.15 ..... **\$428.99 SET** ⚠️

**Universal Hood Latch**



**WASD03**.....ALL  
 This little beauty is called a Rotary Claw Latch. It's spring loaded, "slams" shut just like a bear claw latch and can be

used in a variety of applications like trunks and hoods. It is 1.8" high from the mounting surface to the top, 1.25" from the mounting surface to the striker center and the attachment holes are 3.25" center-to-center. The finish is zinc yellow chromate. Latch has cable release mechanism below the mounting surface. Striker included. -0.15

..... **\$39.00 EA** ⚠️



**WASLH02**.....ALL  
 Matched latch and safety catch with cable release mechanism.

Easy clean installation with a nice zinc yellow chromate finish. Receiver measures 4-13/16" x 2 3/8" Works great on 1935 and later vehicles. -0.15

..... **\$65.00 EA** ⚠️

**Hood Latch Cup Chevy Car**



**3658835C**.....41-50  
 Hood latch cup, stainless.

\*\*Sits on top of latch spring\*\* 8.081 -0.15

..... **\$36.00 EA** ⚠️



**3658835PC**....41-50  
 Hood latch cup, polished stainless.

\*\*Sits on top of latch spring\*\* 8.081 -0.15

..... **\$43.25 EA** ⚠️

**Hood Latch Bolt Chevy Car**



**3654098P**....40-41  
 Polished stainless. Adjustable, upper.

8.083 -0.15

..... **\$34.00 EA** ⚠️



**3664720P**....42-48  
 Adjustable, upper, polished stainless.

8.083 -0.15

..... **\$37.50 EA** ⚠️

**Hood Latch Spring Chevy Car**



**3658835PS** .....41-50  
Hood latch spring, polished stainless.

**\*\*Sits in spring cup\*\*** 8.081 -0.15  
..... **\$31.25 EA** ⚠



**3658835S** .....41-50  
Hood latch spring, stainless.

**\*\*Sits in spring cup\*\*** 8.081 -0.15  
..... **\$27.75 EA** ⚠

**Hood Hinge Springs Chevy Car**

**3659859P** ..... 40-41  
Polished stainless. 8.013 -0.15  
..... **\$133.00 PR** ⚠



**3659859S** .....40-41  
Stainless. 8.013 -0.15 . **\$108.25 PR** ⚠

**3663756P** ..... 42-48  
Polished stainless. 8.013 -0.15  
..... **\$100.25 PR** ⚠



**3663756S** .....42-48  
Stainless. 8.013 -0.15 ... **\$78.75 PR** ⚠

**3700259P** ..... 49-52  
Polished stainless. 8.013 -0.15  
..... **\$138.75 PR** ⚠

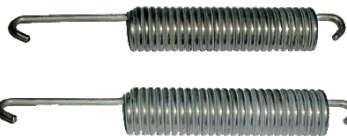

**3700259S** .....49-52  
Stainless. 8.013 -0.15 . **\$118.00 PR** ⚠

**Hood Hinge Springs Chevy Car, cont.**

**3700260P** ..... 53-54  
Polished stainless. 8.013 -0.15  
..... **\$166.00 PR** ⚠



**3700260S** .....53-54  
Stainless. 8.013 -0 ..... **\$125.00 PR** ⚠

**Hood Latch Release Handles**



**ARM1** .....ALL  
Chrome latch release. SINGLE ARM with cables and housing. -0.15 . **\$50.00 KIT** ⚠



**ARM2** .....ALL  
Chrome latch release. DUAL ARM with cables and housing. -0.15  
..... **\$100.19 KIT** ⚠



satin/brushed finish shown

**SMP22020P** .....ALL  
Polished billet aluminum hood release handle with cable. -0 .. **\$99.00 EA** ⚠



**SMP22020S** .....ALL  
Satin finish billet aluminum hood release handle with cable. -0.15 ... **\$85.00 EA** ⚠

**Hood Latch Release Handles, cont.**



**SMP22021P** .....ALL  
Polished billet aluminum dual hood and trunk release handle with cable. -0

..... **\$160.00 EA** ⚠



satin/brushed finish shown

**SMP22021S** .....ALL  
Satin finish aluminum dual hood and trunk release handle with cable. -0  
..... **\$38.00 EA** ⚠

**Hood/ Trunk Props**

**LPP-0401014** ..... ALL  
Adjustable 3 different levels, universal mount. Polished. Includes brackets, fasteners & instructions. 12"-20" length. -0.15  
..... **\$87.25 EA** ⚠



**LPP-0401024** .ALL  
Adjustable 6 different levels universal mount. Polished. Includes brackets, fasteners & instructions. 12"-20" length. -0.15  
..... **\$90.25 EA** ⚠



**SMP22040P** .....ALL  
Universal hood and trunk prop, polished finish -0.15  
..... **\$290.00 EA** ⚠



**SMP22040S** .....ALL  
Universal hood and trunk prop, satin finish -0  
..... **\$260.00 EA** ⚠



**XLPP-0401014** .....ALL  
Black anodized. Adjustable 3 different levels, universal mount. Polished. Includes brackets, fasteners & instructions. 12"-20" length. -0.15  
..... **\$87.25 EA** ⚠

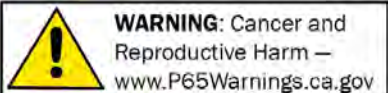

NOTE: Any chemicals will be shipped domestic ground only (Lower 48 states only). No international shipping.

**Hood/ Trunk Props**

**XLPP-0401024** ..... **ALL**  
 Black anodized. Adjustable 6 different levels universal mount. Polished. Includes brackets, fasteners & instructions. 12"-20" length. -0.15 ... **\$87.25 EA** ⚠

**Linear Actuators**

Use linear actuators to open and close trunks, hoods and more.



**12999-6** ..... **ALL**  
 6in. stroke travel, 200lb of lifting force at the push of a button. The unit has a closed length of 14-3/4 inches and an extended length of 18-3/4 inches. Utilizes clevis style attaching points at each end for quick and easy installation. 10.500 -0.15 ..... **\$212.75 EA** ⚠



**13000-8** ..... **ALL**  
 8in. stroke travel, 200lb of lifting force at the push of a button. The unit has a closed length of 16-3/4 inches and an extended length of 24-3/4 inches. Utilizes clevis style attaching points at each end for quick and easy installation. 10.500 -0.15 ..... **\$212.75 EA** ⚠

**13001-10** ..... **ALL**  
 10in. stroke travel, 200lb of lifting force at the push of a button. The unit has a closed length of 18-3/4 inches and an extended length of 28-3/4 inches. Utilizes clevis style attaching points at each end for quick and easy installation. 10.500 -0.15 ..... **\$212.75 EA** ⚠

**13002-12** ..... **ALL**  
 12in. stroke travel, 200lb of lifting force at the push of a button. The unit has a closed length of 20-3/4 inches and an extended length of 32-3/4 inches. Utilizes clevis style attaching points at each end for quick and easy installation. 8.013 -0.15 ..... **\$225.00 EA** ⚠



**13219** ..... **ALL**  
 Universal clevis mounting bracket for actuators. 10.500 -0.15 ..... **\$28.75 EA** ⚠

**Hood Center Strips - Chevy**



**594940SR** ..... **37**  
 Car, no holes. Chrome. 8.015 -0.15 ..... **\$475.00 EA** ⚠



**597480SR** ..... **38**  
 Car, no holes. Chrome. 8.015 -0 ..... **\$527.25 EA** ⚠

**Bullnose**



**3701990A** ..... **40**  
 Car, replaces center strip & hood ornament. 55in. length x 1/2" wide, polished aluminum, w/ clips. 8.015 -0.15 ..... **\$33.00 EA** ⚠

**3701990B** ..... **41**  
 Car, replaces center strip & hood ornament. 57in. length x 1/2" wide, polished aluminum, w/ clips. 8.015 -0.15 ..... **\$33.00 EA** ⚠



**3701990B** ..... **47-53**  
 Truck, replaces center strip & hood ornament. 57 in. length x 1/2" wide, polished aluminum, w/ clips. 8.015 -0.15 ..... **\$33.00 EA** ⚠

**3701990A** ..... **49-52**  
 Car, replaces center strip & hood ornament. 55" length x 1/2" wide, polished aluminum, w/ clips. 8.015 -0.15 ..... **\$33.00 EA** ⚠



**3701990B** ..... **53-54**  
 Car, replaces center strip & hood ornament. 57in. length x 1/2" wide, polished aluminum, w/ clips. 8.015 -0.15 ..... **\$33.00 EA** ⚠

**Hood Side Moulding - Chevy Car**

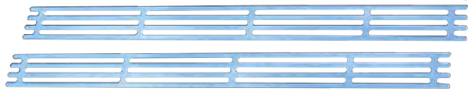

**3653276S** ..... **39**  
 Laser cut stainless.Gangster grille style. 8.005 -0.15 ..... **\$179.75 PR** ⚠

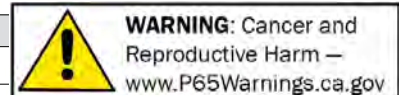

**Front Fender (Fiberglass) -Chevy Car**



- 602635.....37-38
- Left. 8.130 -0.15 ..... \$475.00 EA ⚠
- 602636.....37-38
- Right. 8.130 -0.15 ..... \$475.00 EA ⚠
- 350237.....39
- Left. 8.130 -0.15 ..... \$575.00 EA ⚠
- 350238.....39
- Right. 8.130 -0.15 ..... \$575.00 EA ⚠
- 3652971.....40
- Left. 8.130 -0.15 ..... \$500.00 EA ⚠



- 3652973.....40
- Right. 8.130 -0.15 ..... \$500.00 EA ⚠
- 3684117.....42-48
- Left. 8.130 -0.15 ..... \$500.00 EA ⚠
- 3684118.....42-48
- Right. 8.130 -0.15 ..... \$500.00 EA ⚠

**Front Fender (Fiberglass) -Chevy Truck**



- 594955L.....37-38
- Left. 8.130 -0.15 ..... \$434.69 EA ⚠
- 594956R.....37-38
- Right. 8.130 -0.15 ..... \$434.69 EA ⚠
- 599991L.....39-40
- Left. 8.130 -0.15 ..... \$435.00 EA ⚠
- 599992R.....39-40
- Right. 8.130 -0.15 ..... \$435.00 EA ⚠
- 3664961L.....41-46
- Left. 8.130 -0.15 ..... \$442.50 EA ⚠
- 3664962R.....41-46
- Right. 8.130 -0.15 ..... \$442.50 EA ⚠
- 3682657L.....47-53
- Left. 8.130 -0.15 ..... \$429.00 EA ⚠
- 3682658R.....47-53
- Right. 8.130 -0.15 ..... \$429.00 EA ⚠

**Rear Fenders (Fiberglass) -Chevy Car**



- 597275.....37-38
- Left. 8.203 -0.15 ..... \$365.00 EA ⚠
- 597275W.....37-38
- Left, 2" wider. 8.203 -0.15 ..... \$415.00 EA ⚠
- 597280.....37-38
- Right. 8.203 -0.15 ..... \$365.00 EA ⚠
- 597280W.....37-38
- Right, 2" wider. 8.203 -0.15 .. \$415.00 EA ⚠
- 599341.....39
- Left. 8.203 -0.15 ..... \$415.00 EA ⚠
- 599341W.....39
- Left, 2" wider. 8.203 -0.15 ..... \$415.00 EA ⚠
- 599364.....39
- Right. 8.203 -0.15 ..... \$415.00 EA ⚠
- 599364W.....39
- Right, 2" wider. 8.203 -0.15 .. \$415.00 EA ⚠
- 604627.....40
- Left. 8.203 -0.15 ..... \$379.00 EA ⚠
- 604627W.....40
- Left, 2" wider. 8.203 -0.15 ..... \$415.00 EA ⚠
- 604628.....40
- Right. 8.203 -0.15 ..... \$379.00 EA ⚠
- 604628W.....40
- Right, 2" wider. 8.203 -0.15 .. \$415.00 EA ⚠
- 609657.....41-48
- Left. 8.203 -0.15 ..... \$415.00 EA ⚠
- 609658.....41-48
- Right. 8.203 -0.15 ..... \$415.00 EA ⚠

**Rear Fenders (Fiberglass) -Chevy Truck**



- 594181L.....37-38
- Left. 8.203 -0.15 ..... \$370.00 EA ⚠
- 594181W.....37-38
- Left 2" Wider. 8.203 -0.15 ..... \$415.00 EA ⚠
- 594182R.....37-38
- Right. 8.203 -0.15 ..... \$370.00 EA ⚠
- 594182W.....37-38
- Right 2" Wider. 8.203 -0.15 .. \$415.00 EA ⚠
- 599295L.....39
- Left (1/2, 3/4 & 1T). 8.203 -0.15 ..... \$415.00 EA ⚠
- 599296R.....39
- Right (1/2, 3/4 & 1T). 8.203 -0.15 ..... \$415.00 EA ⚠

**Rear Fenders (Fiberglass) -Chevy Truck, cont.**

- 599121L.....39-46
- Left (Panel, Suburban). 8.164 -0 ..... CALL ⚠
- 599122F.....39-46
- Right (Panel, Suburban). 8.164 -0 .. CALL ⚠
- 3681977L.....40-46
- Left 8.203 -0.15 ..... \$415.00 EA ⚠
- 3681977W.....40-46
- Left, 2" wider, exc 1T. 8.203 -0 ..... CALL ⚠
- 3681978R.....40-46
- Right 8.203 -0.15 ..... \$415.00 EA ⚠
- 3681978W.....40-46
- Right, 2" wider, exc 1T. 8.203 -0 ..... CALL ⚠
- 3682835L.....47-54
- Left (all pickups). 8.203 -0.15 ..... \$415.00 EA ⚠
- 3682835W.....47-54
- Left, 2-1/2" wider, all pickups. 8.203 -0.15 ..... \$435.00 EA ⚠
- 3682836R.....47-54
- Right (all pickups). 8.203 -0.15 ..... \$415.00 EA ⚠
- 3682836W.....47-54
- Right, 2-1/2" wider, all pickups. 8.203 -0.15 ..... \$435.00 EA ⚠
- 3684691L.....47-54
- Left (Panel, Suburban). 8.203 -0.15 ..... \$435.00 EA ⚠
- 3684692R.....47-54
- Right (Panel, Suburban). 8.203 -0.15 ..... \$435.00 EA ⚠

**Rear Fenders (Steel) -Chevy Truck**



- 3681977.....40-46
- Left, all commercial cabs (exc. KF, AN, BN, DS) 8.203 -0 ..... \$995.00 EA ⚠
- 3681978.....40-46
- Right, all commercial cabs (exc. KF, AN, BN, DS) 8.203 -0 ..... \$993.25 EA ⚠

**Fender Grilles Laser Cut Chevy Car**



- 603837LS.....39
- Polished Stainless Steel, Laser Cut. 1.266 -0.15 ..... \$164.75 L&R ⚠

**WARNING: Cancer and Reproductive Harm —**  
www.P65Warnings.ca.gov

NOTE: Any chemicals will be shipped domestic ground only (Lower 48 states only). No international shipping.

**Front Fender Extension (Fiberglass) -Chevy Car**

Note: Fiberglass parts are made to order. Oversize shipping charges may apply. Please call for rates.



**3663517F** .....42-48  
Left. 8.131 -0  
..... **CALL** ⚠

**3663518F** .....42-48  
Right. 8.131 -0  
..... **CALL** ⚠

**Inner Fender Panels (Fiberglass) -Chevy Car**



**594221B** .....37-38  
Front. 8.153 -0.15 ..... **\$325.00 L&R** ⚠



**350609B** ..... 39  
Front. 8.153 -0 ..... **CALL** ⚠  
**3658787F** ..... 41  
Left. 8.153 -0 ..... **CALL** ⚠  
**3658788F** ..... 41  
Right. 8.153 -0 ..... **CALL** ⚠  
**3664301F** ..... 42-48  
Left. 8.153 -0 ..... **CALL** ⚠  
**3664302F** ..... 42-48  
Right. 8.153 -0 ..... **CALL** ⚠

**Inner Fender Panels (Fiberglass) -Chevy Truck**



**595889F** .....37-38  
Left. 8.164 -0  
..... **CALL** ⚠

**595890F** .....37-38  
Right. 8.164 -0  
..... **CALL** ⚠



**3664975F** .....41-46  
Left. 8.164 -0  
..... **CALL** ⚠



**3664976F** .....41-46  
Right. 8.164 -0.15  
..... **\$250.00 EA** ⚠

**Inner Baffle (Fiberglass) - Chevy Car**



**3664113F** .....42-48  
Behind headlight bucket, left. 8.164 -0  
..... **CALL** ⚠



**3664114F** .....42-48  
Behind headlight bucket, right. 8.164 -0  
..... **CALL** ⚠

**Inner Fender Apron Kit - Chevy Truck**

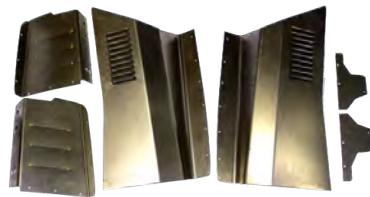

**3686239** .....47-54  
Inner fender Apron Kit. Cleans look of engine bay. Bolt-in. Stock or Smooth firewalls/ core supports. 16.545 -0.15  
..... **\$415.00 SET** ⚠

**Core Support Panel (Fiberglass) - Chevy Car**



**3653849F** ..... 40  
Front left, fiberglass.  
8.153 -0  
..... **CALL** ⚠



**3653850F** ..... 40  
Front right, fiberglass.  
8.153 -0  
..... **CALL** ⚠

**Fender Skirts Chevy Car**

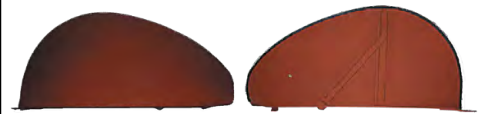

**985641** .....37-48  
Superb die-stamped production of 1940 original steel tear drop skirts. Includes s rubber seals. These were an original factory accessory for 1940 Packard and Ford

These will also fit:  
1938-1940 Ford  
1937-1940 Plymouth  
1937-1940 Dodge  
1937-1940 Desoto  
1937-1940 Cadillac  
1939-1940 Studebaker  
1937-1947 Oldsmobile  
1939-1947 Packard  
1937-1941 6 & 8 Standard Pontiac

8.175 -0.15 ..... **\$521.25 L&R** ⚠  
**985873** ..... 41-48  
Exc Fleetline. Nice repro. Original 42-48. Includes rubber seals. 8.175 -0.15  
..... **\$274.50 L&R** ⚠



**985874** .....41-48  
Fleetline w/ mouldings. Nice repro. Original 42-48. Includes rubber seals. 8.175 -0.15 ..... **\$315.25 L&R** ⚠



**3693333** .....49-50  
Die stamped. Superb reproduction. Includes rubber seals. 8.175 -0 ... **CALL** ⚠



**3695982** .....51-52  
Die stamped. Superb reproduction. Includes rubber seals. 8.175 -0 ... **CALL** ⚠

**Fender Skirts Chevy Car, cont.**



**3705104**.....**53-54**  
Die stamped. Superb reproduction.  
Includes rubber seals. 8.175 -0.15  
..... **\$145.25 PR** ⚠

**Fender Skirt Trim (Bloomers)**

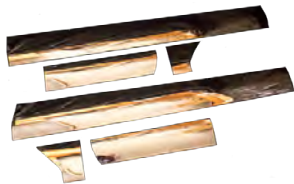

**3705105**.....**49-50**  
Lower, stainless steel w/ mounting  
hardware. Fits 2 Door 8.175 -0.15  
..... **\$430.00 PR** ⚠

**3705106**.....**49-50**  
Lower, stainless steel w/ mounting  
hardware. Fits 4 Door. 8.175 -0  
..... **\$430.00 PR** ⚠



**3705103**.....**53-54**  
Lower, stainless steel w/ mounting  
hardware. Fits Bel Air & 210. 8.175 -0.15  
..... **\$170.25 PR** ⚠

**Fender Marker (Guide)**



**985134**.....**37-54**  
Illuminated. Clamps to  
front fender, chrome  
plated. Milky colored  
top w/ clear lens &  
stainless fin. 15.5"  
tall -0.15  
..... **\$63.00 PR** ⚠



**985134BULB** ....**ALL**  
Replacement bulb. 3  
watt, 12 volt threaded  
base -0.15  
..... **\$1.00 EA** ⚠



**985135**.....**ALL**  
lighted Fender Guide,  
Chrome With Green,  
Red, Blue Or Amber  
Inserts -0.15  
..... **\$60.00 PR** ⚠

**Curb Feelers**



**985289A** .....**ALL**  
Chrome flex wire, clamp on vintage  
accessory helps prevent wheel & fender  
damage by creating a noticeable scraping  
sound when vehicle is too close to the  
curb.

8.214 -0.15 ..... **\$9.50 PR** ⚠



**985289B** .....**ALL**  
Chrome plated, vintage clamp on  
accessory helps prevent wheel & fender  
damage by creating a noticeable scraping  
sound when vehicle is too close to the  
curb. 8.214 -0.15 ..... **\$12.75 PR** ⚠

**Fender Washers**



**PCW1503V**.....**ALL**  
Machined aluminum, brushed finish.  
1.475" dia. x .459 height.  
3/8"-16 x 1-3/4" allen head bolt. -0.15  
..... **\$20.00 EA** ⚠

**Fender Braces - Rear, 2" Wider Fenders Chevy**

Stock length fender braces for 37-48 Chevy cars & 47-54 Chevy trucks also available.



**594203L**.....**37**  
Car, fender brace. Rear, for 2 in. widened  
fenders, 15-1/4" long. 8.212 -0.3  
..... **\$15.50 EA** ⚠

**597279L**.....**38**  
Car rear, steel for 2" widened fenders.  
8.212 -0.3 ..... **\$15.50 EA** ⚠

**598238L**.....**39**  
Car rear, steel for 2" widened fenders.  
8.212 -0.3 ..... **\$15.50 EA** ⚠

**3652627L**.....**40**  
Car rear, steel for 2" widened fenders.  
8.212 -0.15 ..... **\$15.50 EA** ⚠

**Fender Braces - Rear, 2" Wider Fenders Chevy, cont.**

**3658019L** ..... **41-48**  
Car rear, steel for 2" widened fenders.  
8.212 -0.4 ..... **\$15.50 EA** ⚠  
**3683947A** .....**47-54**  
Truck rear, for 2" widened fenders.  
8.212 -0.4 ..... **\$15.50 EA** ⚠

**Fender Welting**



**601726**.....**ALL**  
Black 1/4in. x 1-3/16in. 37-48 rear  
fenders use approx 15 ft. 8.205 -0  
..... **\$0.99 FT** ⚠



**601726C** .....**ALL**  
Chrome mylar (1-1/4" x 3/16" ). 8.205 -0  
..... **\$1.99 FT** ⚠



**601726S**.....**ALL**  
W/ stainless steel bead. 8 foot length,  
1/4" wide bead w/ 1-5/16" flange.  
8.205 -0.15 ..... **\$30.59 EA** ⚠

**Fender Script Emblems**



**R6272**.....**ALL**  
"Supercharged" Emblem -0.15  
..... **\$10.39 EA** ⚠



**R6273**.....**ALL**  
"Streetrod" Emblem -0.2 ..... **\$11.00 EA** ⚠



**R6274**.....**ALL**  
"Hotrod" Emblem -0.2 ..... **\$9.75 EA** ⚠

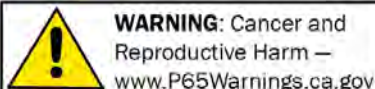

**WARNING: Cancer and Reproductive Harm** —  
www.P65Warnings.ca.gov

NOTE: Any chemicals will be shipped domestic ground only (Lower 48 states only). No international shipping.

Fender Script Emblems, cont.

*Blown*

R6276.....ALL  
"Blown" Emblem -0.15 ... \$10.19 EA ⚠

*Cruisin*

R6277.....ALL  
"Cruisin" Emblem -0.2 .. \$11.25 EA ⚠

*Turbocharged*

R6278.....ALL  
"Turbocharged" Emblem -0.15  
..... \$10.00 EA ⚠



**WARNING:** Cancer and Reproductive Harm — [www.P65Warnings.ca.gov](http://www.P65Warnings.ca.gov)

**Ford Die Stamped Sheet Metal**

22627.....	.37-40	
Tailpan 1937-38 ford humpback -0.15		
		\$310.00 ⚠
22628.....	.37-40	
Tailpan 1937 ford flatback -0.15		
		\$310.00 ⚠
22629.....	.37-40	
Tailpan 1937-38 ford coupe, cabriolet, roadster -0.15		
		\$310.00 ⚠
22630.....	.37-40	
Toolbox compartment all 1937 ford body styles, 1938 ford std sedans, 1938 ford std & deluxe coupe -0.15		
		\$260.00 ⚠
22631.....	.37-40	
Trunk floor kit ford 1937 all, 1938 std sedan, 1938 std & deluxe coupes -0.15		
		\$285.00 ⚠
22632.....	.37-40	
Tailpan ford 1938 deluxe sedan, 1939 & 40 std and deluxe sedans -0.15		
		\$310.00 ⚠
22633.....	.37-40	
Tailpan with bumper slots ford 1939 & 40 coupe -0.15		
		\$260.00 ⚠
22634.....	.37-40	
Tailpan without slots ford 1939 & 40 coupe -0.15		
		\$260.00 ⚠
22635.....	.37-40	
Fender patch panel left ford 1935-40 cars -0.15		
		\$98.00 ⚠
22636.....	.37-40	
Fender patch panel right ford 1935-40 cars -0.15		
		\$98.00 ⚠
22637.....	.37-40	
Toolbox (trunk floor extension) ford 1939-40 coupe and 1938-40 sedan w/ slight mods -0.15		
		\$265.00 ⚠
22638.....	.37-40	
Door post braces ford 1935-40 -0.15		
		\$65.00 ⚠
22639.....	.37-40	
Door bottom repair kit left ford 1937-40 2dr sedan (long door), cabriolet, club coupe -0.15		
		\$195.00 ⚠
22640.....	.37-40	
Door bottom repair kit right ford 1937-40 2dr sedan (long door), cabriolet, club coupe -0.15		
		\$195.00 ⚠

**Ford Die Stamped Sheet Metal, cont.**

22641.....	.37-40	
Door bottom repair kit left ford 1937-40 business coupe, 4dr sedan (front door), sedan delivery -0.15		
		\$195.00 ⚠
22642.....	.37-40	
Door bottom repair kit right ford 1937-40 business coupe, 4dr sedan (front door), sedan delivery -0.15		
		\$195.00 ⚠
22643.....	.37-40	
Rocker panels ford 1937-40 all body styles -0.15		
		\$120.00 PR ⚠
22644.....	.37-40	
Lower front left cowl panel ford 1937-38 all bodies, 1939 standard -0.15		
		\$145.00 ⚠
22645.....	.37-40	
Lower front right cowl panel ford 1937-38 all bodies, 1939 standard -0.15		
		\$145.00 ⚠
22646.....	.37-40	
Cowl inner front left ford 1937-39 standard -0.15		
		\$105.00 ⚠
22647.....	.37-40	
Cowl inner front right ford 1937-39 standard -0.15		
		\$105.00 ⚠
22648.....	.37-40	
Rear floor pan kit ford 1937-40 all bodies -0.15		
		\$175.00 ⚠
22649.....	.37-40	
Floor pan for stock firewall ford 1935-40 all body's -0.15		
		\$270.00 ⚠
22650.....	.37-40	
Lower front left cowl ford 1939 deluxe , 1940 all bodies -0.15		
		\$125.00 ⚠
22651.....	.37-40	
Lower front right cowl ford 1939 deluxe , 1940 all bodies -0.15		
		\$125.00 ⚠
22652.....	.37-40	
Lower left rear quarter panel ford 1937-40 2 door sedan, cabriolet, club coupe (long door) -0.15		
		\$115.00 ⚠
22653.....	.37-40	
Lower right rear quarter panel ford 1937-40 2 door sedan, cabriolet, club coupe (long door) -0.15		
		\$115.00 ⚠

**Ford Die Stamped Sheet Metal, cont.**

22654.....	.37-40	
Lower left rear quarter panel ford 1937-40 coupe , business coupe (short door) -0.15		
		\$115.00 ⚠
22655.....	.37-40	
Lower right rear quarter panel ford 1937-40 coupe , business coupe (short door) -0.15		
		\$115.00 ⚠
22656.....	.37-40	
Trunk floor kit ford 1939-40 coupe -0.15		
		\$295.00 ⚠
22657.....	.37-40	
Trunk floor kit ford 1938-40 sedan, 1938 deluxe sedan, 1939-40 all sedan's -0.15		
		\$295.00 ⚠
22658.....	.41-48	
Tailpan (full rollpan) ford 1941-48 ford sedan, coupe, will not fit sedan delivery or woody -0.15		
		\$310.00 ⚠
22659.....	.41-48	
Toolbox compartment ford 1941 to mid 1946 ford & mercury, all sedans and coupes -0.15		
		\$135.00 ⚠
22660.....	.41-48	
Trunk floor 1941-early 1946 ford & mercury, all sedans & coupes -0.15		
		\$159.00 ⚠
22661.....	.41-48	
Door bottom repair kit left ford 1941-48 2dr sedan and club coupe ( long door) -0.15		
		\$195.00 ⚠
22662.....	.41-48	
Door bottom repair kit right ford 1941-48 2dr sedan and club coupe ( long door) -0.15		
		\$195.00 ⚠
22663.....	.41-48	
Door bottom repair kit left ford 1941-48, 4 dr sedan-front door , 2 dr business coupe (short door) -0.15		
		\$195.00 ⚠
22664.....	.41-48	
Door bottom repair kit right ford 1941-48, 4 dr sedan-front door, 2 dr business coupe (short door) -0.15		
		\$195.00 ⚠
22665.....	.41-48	
Left center rocker box ford 4dr sedan and business coupe, woody wagon -0.15		
		\$165.00 ⚠

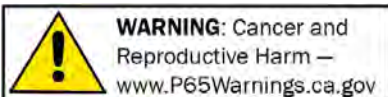

NOTE: Any chemicals will be shipped domestic ground only (Lower 48 states only). No international shipping.



**Ford Die Stamped Sheet Metal, cont.**

<b>22666</b> .....	<b>41-48</b>	
Right center rocker box ford 4dr sedan and business coupe, woody wagon -0.15		
.....		<b>\$165.00</b> ⚠
<b>22667</b> .....	<b>41-48</b>	
Left rear rocker box ford 1941-48 2 door sedan, club coupe -0.15		
.....		<b>\$75.00</b> ⚠
<b>22668</b> .....	<b>41-48</b>	
Right rear rocker box ford 1941-48 2 door sedan, club coupe -0.15		
.....		<b>\$75.00</b> ⚠
<b>22669</b> .....	<b>41-48</b>	
Left center rocker box ford 4 door sedan and business coupe, woody wagon -0.15		
.....		<b>\$155.00</b> ⚠
<b>22670</b> .....	<b>41-48</b>	
Right center rocker box ford 4 door sedan and business coupe, woody wagon -0.15		
.....		<b>\$155.00</b> ⚠
<b>22671</b> .....	<b>41-48</b>	
Rear rocker box ford 1941-48 4 sedan, business coupe , sedan delivery -0.15		
.....		<b>\$80.00</b> ⚠
<b>22672</b> .....	<b>41-48</b>	
Rear rocker box ford 1941-48 4 sedan, business coupe , sedan delivery -0.15		
.....		<b>\$80.00</b> ⚠
<b>22673</b> .....	<b>41-48</b>	
Front left rocker box ford 1941-48 all body styles -0.15		
.....		<b>\$125.00</b> ⚠
<b>22674</b> .....	<b>41-48</b>	
Front right rocker box ford 1941-48 all body styles -0.15		
.....		<b>\$125.00</b> ⚠
<b>22675</b> .....	<b>41-48</b>	
Lower front left cowl ford all body styles -0.15		
.....		<b>\$175.00</b> ⚠
<b>22676</b> .....	<b>41-48</b>	
Lower front right cowl ford all body styles -0.15		
.....		<b>\$175.00</b> ⚠
<b>22677</b> .....	<b>41-48</b>	
Lower Left Rear Quarter Panel Ford 1941 2dr Sedan, Club Coupe, Convertible -0.15		
.....		<b>\$125.00</b> ⚠
<b>22678</b> .....	<b>41-48</b>	
Lower Right Rear Quarter Panel Ford 1941 2dr Sedan, Club Coupe, Convertible -0.15		
.....		<b>\$125.00</b> ⚠

**Ford Die Stamped Sheet Metal, cont.**

<b>22679</b> .....	<b>41-48</b>	
Lower left rear quarter panel ford 1941-48 business coupe, sedan delivery -0.15		
.....		<b>\$125.00</b> ⚠
<b>22680</b> .....	<b>41-48</b>	
Lower right rear quarter panel ford 1941-48 business coupe, sedan delivery -0.15		
.....		<b>\$125.00</b> ⚠
<b>22681</b> .....	<b>41-48</b>	
Tailpan ford 1947 late to 1948 all body styles -0.15		
.....		<b>\$135.00</b> ⚠
<b>22682</b> .....	<b>41-48</b>	
Lower left front fender section ford all bodies -0.15		
.....		<b>\$85.00</b> ⚠
<b>22683</b> .....	<b>41-48</b>	
Lower right front fender section ford all bodies -0.15		
.....		<b>\$85.00</b> ⚠
<b>22684</b> .....	<b>41-48</b>	
Front floor pan kit- universal 1941-48 ford all body styles -0.15		
.....		<b>\$270.00</b> ⚠
<b>22685</b> .....	<b>41-48</b>	
Rear floor pan kit 1941-48 ford all body styles -0.15		
.....		<b>\$260.00</b> ⚠
<b>22686</b> .....	<b>41-48</b>	
Rear seat riser ford 1941-48 all bodies except sedan delivery -0.15		
.....		<b>\$150.00</b> ⚠
<b>22687</b> .....	<b>41-48</b>	
Trunk floor kit ford late 1946 ford to 1948 (without toolbox compartment.) -0.15		
.....		<b>\$185.00</b> ⚠
<b>23188</b> .....	<b>49-50</b>	
Front Toe Board Left 49-50 Ford (Exc Wagon) -0.15		
.....		<b>\$125.00 EA</b> ⚠
<b>23189</b> .....	<b>49-50</b>	
Front Toe Board Right 49-50 Ford (Exc Wagon) -0.15		
.....		<b>\$125.00 EA</b> ⚠
<b>22688</b> .....	<b>49-51</b>	
Tailpan ford all sedans, coupe, convert -0.15		
.....		<b>\$145.00</b> ⚠
<b>22689</b> .....	<b>49-51</b>	
Left lower fender section, rear of front fender. Ford 1949-51 all body styles -0.15		
.....		<b>\$85.00</b> ⚠
<b>22690</b> .....	<b>49-51</b>	
Right lower fender section, rear of front fender. Ford 1949-51 all body styles -0.15		
.....		<b>\$85.00</b> ⚠

**Ford Die Stamped Sheet Metal, cont.**

<b>22691</b> .....	<b>49-51</b>	
Floor brace - front left ford 1949-51 all bodies -0.15		
.....		<b>\$79.00</b> ⚠
<b>22692</b> .....	<b>49-51</b>	
Floor brace - front right ford 1949-51 all bodies -0.15		
.....		<b>\$79.00</b> ⚠
<b>22693</b> .....	<b>49-51</b>	
Floor brace -rear ford 1949-51 all body styles -0.15		
.....		<b>\$79.00</b> ⚠
<b>22694</b> .....	<b>49-51</b>	
Rocker panel left ford 1949-51 all bodies except woody wagon -0.15		
.....		<b>\$125.00</b> ⚠
<b>22695</b> .....	<b>49-51</b>	
Rocker panel right ford 1949-51 all bodies except woody wagon -0.15		
.....		<b>\$125.00</b> ⚠
<b>22696</b> .....	<b>49-51</b>	
Full rollpan ford 1949-51 2/4 sedans, coupes, convert -0.15		
.....		<b>\$225.00</b> ⚠
<b>22697</b> .....	<b>49-51</b>	
Lower left front quarter panel ford 1949-51 2-sedan, coupe, conv. -0.15		
.....		<b>\$185.00</b> ⚠
<b>22698</b> .....	<b>49-51</b>	
Lower right front quarter panel ford 1949-51 2-sedan, coupe, conv. -0.15		
.....		<b>\$185.00</b> ⚠
<b>22699</b> .....	<b>49-51</b>	
Lower left rear quarter panel ford 1949-51 2/4 sd, conv, coupe -0.15		
.....		<b>\$185.00</b> ⚠
<b>22700</b> .....	<b>49-51</b>	
-0.15		
.....		<b>\$185.00</b> ⚠
<b>22701</b> .....	<b>49-51</b>	
Trunk floor extension ford 1949-51 2/4 sedan, coupe, conv. -0.15		
.....		<b>\$175.00</b> ⚠
<b>22702</b> .....	<b>49-51</b>	
Trunk floor left main section ford 1949-51 2/4 sedan, coupe, conv. -0.15		
.....		<b>\$175.00</b> ⚠
<b>22703</b> .....	<b>49-51</b>	
Trunk floor right main section ford 1949-51 2/4 sedan, coupe, conv. -0.15		
.....		<b>\$175.00</b> ⚠
<b>22704</b> .....	<b>49-51</b>	
Front floor kit ford 1949-51 2 or 4 door sedan, coupe, conv. -0.15		
.....		<b>\$345.00</b> ⚠
<b>22705</b> .....	<b>49-51</b>	
Toe board kit ford 1949-51 2 or 4 door sedan, coupe, covert. -0.15		
.....		<b>\$250.00</b> ⚠

Returns require a return authorization number—Please call first. · Note: Product pricing and availability subject to change.



# Section 295: Sheet Metal & Fiberglass

## Ford Die Stamped Sheet Metal, cont.

<b>22706</b> .....	<b>49-51</b>
Rear floor pan ford all sedan, coupe, conv. -0.15	
.....	<b>\$297.00</b> ⚠
<b>22707</b> .....	<b>49-51</b>
Inner front left fender brace ford all bodies -0.15	
.....	<b>\$63.00</b> ⚠
<b>22708</b> .....	<b>49-51</b>
Inner front right fender brace ford all bodies -0.15	
.....	<b>\$63.00</b> ⚠
<b>22709</b> .....	<b>49-51</b>
Spare tire well ford 1949-54 all bodies -0.15	
.....	<b>\$150.00</b> ⚠
<b>22710</b> .....	<b>49-51</b>
Inner rocker panel ford 1949-51 all body styles (exc. Wagon) -0.15	
.....	<b>\$49.00</b> ⚠
<b>22711</b> .....	<b>49-51</b>
Door bottom repair kit left ford 1949-51 all 2 door bodies (exc. Wagon) -0.15	
.....	<b>\$195.00</b> ⚠
<b>22712</b> .....	<b>49-51</b>
Door bottom repair kit right ford 1949-51 all 2 door bodies (exc. Wagon) -0.15	
.....	<b>\$195.00</b> ⚠
<b>22713</b> .....	<b>49-51</b>
Outer rocker panel left ford 1949-51 4 door body, front door -0.15	
.....	<b>\$89.00</b> ⚠
<b>22714</b> .....	<b>49-51</b>
Outer rocker panel right ford 1949-51 4 door body, front door -0.15	
.....	<b>\$89.00</b> ⚠
<b>22715</b> .....	<b>49-51</b>
Outer rocker panel left ford 1949-51 4 door body, rear door -0.15	
.....	<b>\$65.00</b> ⚠
<b>22716</b> .....	<b>49-51</b>
Outer rocker panel right ford 1949-51 4 door body, rear door -0.15	
.....	<b>\$65.00</b> ⚠
<b>22717</b> .....	<b>52-54</b>
Outer rocker panel left ford 1952-54 all 2 door body, including 2 door wagon and sedan delivery. -0.15	
.....	<b>\$99.00</b> ⚠
<b>22718</b> .....	<b>52-54</b>
Outer rocker panel right ford 1952-54 all 2 door body, including 2 door wagon and sedan delivery. -0.15	
.....	<b>\$99.00</b> ⚠
<b>22719</b> .....	<b>52-54</b>
Outer rocker panel left ford 1952-54 4 door body, front door -0.15	
.....	<b>\$99.00</b> ⚠

## Ford Die Stamped Sheet Metal, cont.

<b>22720</b> .....	<b>52-54</b>
Outer rocker panel right ford 1952-54 4 door body, front door -0.15	
.....	<b>\$99.00</b> ⚠
<b>22721</b> .....	<b>52-54</b>
Outer rocker panel left ford 1952-54 4 door body, rear door -0.15	
.....	<b>\$79.00</b> ⚠
<b>22722</b> .....	<b>52-54</b>
Outer Rocker Panel Right Ford 1952-54 4 Door Body, Rear Door -0.15	
.....	<b>\$79.00</b> ⚠
<b>22723</b> .....	<b>52-54</b>
Inner rocker panel left ford 1952-54 2 door body and 4 door front door -0.15	
.....	<b>\$49.00</b> ⚠
<b>22724</b> .....	<b>52-54</b>
Inner rocker panel right ford 1952-54 2 door body and 4 door front door -0.15	
.....	<b>\$49.00</b> ⚠
<b>22725</b> .....	<b>52-54</b>
Inner rocker panel left ford 1952-54 4 door body rear door -0.15	
.....	<b>\$42.00</b> ⚠
<b>22726</b> .....	<b>52-54</b>
Inner rocker panel right ford 1952-54 4 door body rear door -0.15	
.....	<b>\$42.00</b> ⚠
<b>22727</b> .....	<b>52-54</b>
Front floor board left ford 1952-54 all bodies -0.15	
.....	<b>\$185.00</b> ⚠
<b>22728</b> .....	<b>52-54</b>
Front floor board right ford 1952-54 all bodies -0.15	
.....	<b>\$185.00</b> ⚠
<b>22729</b> .....	<b>52-54</b>
Front toe board left, ford 1952-54 all body styles (also fits mercury) -0.15	
.....	<b>\$125.00</b> ⚠
<b>22730</b> .....	<b>52-54</b>
Front toe board right, ford 1952-54 all body styles (also fits mercury) -0.15	
.....	<b>\$125.00</b> ⚠
<b>22731</b> .....	<b>52-54</b>
Lower left rear of front fender section ford 1952-54 all bodies -0.15	
.....	<b>\$81.00</b> ⚠
<b>22732</b> .....	<b>52-54</b>
Lower right rear of front fender section ford 1952-54 all bodies -0.15	
.....	<b>\$81.00</b> ⚠
<b>22733</b> .....	<b>52-54</b>
Inner brace lower left front fender ford 1952-54 all bodies -0.15	
.....	<b>\$41.00</b> ⚠
<b>22734</b> .....	<b>52-54</b>
Inner brace lower right front fender ford 1952-54 all bodies -0.15	
.....	<b>\$41.00</b> ⚠

## Ford Die Stamped Sheet Metal, cont.

<b>22735</b> .....	<b>55-56</b>
Outer rocker panel left ford 1955-56 all 2 door bodies including wagon and sedan delivery -0.15	
.....	<b>\$125.00</b> ⚠
<b>22736</b> .....	<b>55-56</b>
Outer rocker panel right ford 1955-56 all 2 door bodies including wagon and sedan delivery -0.15	
.....	<b>\$125.00</b> ⚠
<b>22737</b> .....	<b>55-56</b>
Lower front left quarter panel ford 1955-56 all 2 door bodies -0.15	
.....	<b>\$185.00</b> ⚠
<b>22738</b> .....	<b>55-56</b>
Lower front right quarter panel ford 1955-56 all 2 door bodies -0.15	
.....	<b>\$185.00</b> ⚠
<b>22739</b> .....	<b>55-56</b>
Lower rear left quarter panel ford 1955-56 all bodies -0.15	
.....	<b>\$185.00</b> ⚠
<b>22740</b> .....	<b>55-56</b>
Lower rear right quarter panel ford 1955-56 all bodies -0.15	
.....	<b>\$185.00</b> ⚠
<b>22741</b> .....	<b>55-56</b>
Tailpan ford 1955-56 all bodies (exc. Wagon and sedan delivery) -0.15	
.....	<b>\$310.00</b> ⚠
<b>22742</b> .....	<b>55-56</b>
Rear floor pan left ford 1955-56 all bodies -0.15	
.....	<b>\$199.00</b> ⚠
<b>22743</b> .....	<b>55-56</b>
Rear floor pan right ford 1955-56 all bodies -0.15	
.....	<b>\$199.00</b> ⚠
<b>22744</b> .....	<b>55-56</b>
Front floor pan left ford 1955-56 all bodies -0.15	
.....	<b>\$185.00</b> ⚠
<b>22745</b> .....	<b>55-56</b>
Front floor pan right ford 1955-56 all bodies -0.15	
.....	<b>\$185.00</b> ⚠
<b>22746</b> .....	<b>55-56</b>
Toe board left ford 1955-56 all bodies -0.15	
.....	<b>\$125.00</b> ⚠
<b>22747</b> .....	<b>55-56</b>
Toe board right ford 1955-56 all bodies -0.15	
.....	<b>\$125.00</b> ⚠
<b>22748</b> .....	<b>55-56</b>
Inner rear left quarter panel ford 1955-56 all bodies -0.15	
.....	<b>\$149.00</b> ⚠

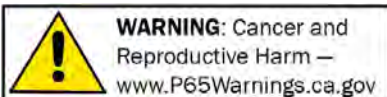

NOTE: Any chemicals will be shipped domestic ground only (Lower 48 states only). No international shipping.

**(800) 952-1752 • www.streetrodhq.com**

**Ford Die Stamped Sheet Metal, cont.**

<b>22749</b> .....	<b>.55-56</b>	
Inner rear right quarter panel ford 1955-56 all bodies -0.15		
.....		<b>\$149.00</b> ⚠
<b>22750</b> .....	<b>.55-56</b>	
Lower left rear of front fender section -0.15		
.....		<b>\$81.00</b> ⚠
<b>22751</b> .....	<b>.55-56</b>	
Lower right rear of front fender section -0.15		
.....		<b>\$81.00</b> ⚠
<b>22752</b> .....	<b>.55-56</b>	
Inner fender brace left ford 1955-56 all bodies -0.15		
.....		<b>\$49.00</b> ⚠
<b>22753</b> .....	<b>.55-56</b>	
Inner fender brace right ford 1955-56 all bodies -0.15		
.....		<b>\$49.00</b> ⚠
<b>22754</b> .....	<b>.55-56</b>	
Inner rocker left ford 1955-56 all 2 door bodies -0.15		
.....		<b>\$49.00</b> ⚠
<b>22755</b> .....	<b>.55-56</b>	
Inner rocker right ford 1955-56 all 2 door bodies -0.15		
.....		<b>\$49.00</b> ⚠
<b>22756</b> .....	<b>.55-56</b>	
Outer rocker panel front left ford 1955-56 4 door bodies including wagon -0.15		
.....		<b>\$99.00</b> ⚠
<b>22757</b> .....	<b>.55-56</b>	
Outer rocker panel front right ford 1955-56 4 door bodies including wagon -0.15		
.....		<b>\$99.00</b> ⚠
<b>22758</b> .....	<b>.55-56</b>	
Rear rocker panel left ford 1955-56 4 door body, rear door -0.15		
.....		<b>\$79.00</b> ⚠
<b>22759</b> .....	<b>.55-56</b>	
Rear rocker panel right ford 1955-56 4 door body, rear door -0.15		
.....		<b>\$79.00</b> ⚠
<b>22760</b> .....	<b>.55-56</b>	
Inner rocker front door left ford 1955-56 4 door body, front door -0.15		
.....		<b>\$49.00</b> ⚠
<b>22761</b> .....	<b>.55-56</b>	
Inner rocker front door right ford 1955-56 4 door body, front door -0.15		
.....		<b>\$49.00</b> ⚠
<b>22762</b> .....	<b>.55-56</b>	
Inner rocker rear door left ford 1955-56 4 door body, rear door -0.15		
.....		<b>\$42.00</b> ⚠

**Ford Die Stamped Sheet Metal, cont.**

<b>22763</b> .....	<b>.55-56</b>	
Inner rocker rear door right ford 1955-56 4 door body, rear door -0.15		
.....		<b>\$42.00</b> ⚠
<b>22764</b> .....	<b>.55-56</b>	
Inner front left quarter panel ford 1955-56 2 door sedan, conv. And 2 door wagon -0.15		
.....		<b>\$39.00</b> ⚠
<b>22765</b> .....	<b>.55-56</b>	
Inner front right quarter panel ford 1955-56 2 door sedan, conv. And 2 door wagon -0.15		
.....		<b>\$39.00</b> ⚠
<b>22766</b> .....	<b>.55-56</b>	
Floor brace 1st row ford 1955-56 all bodies -0.15		
.....		<b>\$81.00</b> ⚠
<b>22767</b> .....	<b>.55-56</b>	
Floor brace 2nd row left side ford 1955-56 all bodies -0.15		
.....		<b>\$81.00</b> ⚠
<b>22768</b> .....	<b>.55-56</b>	
Floor brace 2nd row right side ford 1955-56 all bodies -0.15		
.....		<b>\$81.00</b> ⚠
<b>22769</b> .....	<b>.55-56</b>	
Floor brace 3rd row left side ford 1955-56 all bodies -0.15		
.....		<b>\$81.00</b> ⚠
<b>22770</b> .....	<b>.55-56</b>	
Floor brace 3rd row right side ford 1955-56 all bodies -0.15		
.....		<b>\$81.00</b> ⚠
<b>22771</b> .....	<b>.55-56</b>	
Floor brace 4th row left side ford 1955-56 convertible, and hardtops only -0.15		
.....		<b>\$81.00</b> ⚠
<b>22772</b> .....	<b>.55-56</b>	
Floor brace 4th row right side ford 1955-56 convertible, and hardtops only -0.15		
.....		<b>\$81.00</b> ⚠
<b>22773</b> .....	<b>.55-56</b>	
Floor brace left 4th row post 2/4 door sedans and wagons, 5th row brace for conv. Hardtop -0.15		
.....		<b>\$81.00</b> ⚠
<b>22774</b> .....	<b>.55-56</b>	
Floor brace right 4th row post 2/4 door sedans and wagons, 5th row brace for conv. Hardtop -0.15		
.....		<b>\$81.00</b> ⚠

**Firewall (Steel) -Chevy Car W/ V8**



<b>4091695X39</b> .....	<b>.37-39</b>	
Small block. 12.803 -0.15		
.....		<b>\$366.25 EA</b> ⚠
<b>4091695Y39</b> .....	<b>.37-39</b>	
Big block. 12.803 -0.15		
.....		<b>\$371.75 EA</b> ⚠
<b>4103067X40</b> .....	<b>40</b>	
Small block. 12.803 -0.15		
.....		<b>\$367.50 EA</b> ⚠
<b>4103067Y40</b> .....	<b>40</b>	
Big block. 12.803 -0.15		
.....		<b>\$371.75 EA</b> ⚠
<b>4117580X48</b> .....	<b>41-48</b>	
Small block. 12.803 -0.15		
.....		<b>\$367.49 EA</b> ⚠
<b>4117580Y48</b> .....	<b>41-48</b>	
Big block. 12.803 -0.15		
.....		<b>\$355.00 EA</b> ⚠
<b>4613220X52</b> .....	<b>49-52</b>	
Small block or big block. 12.803 -0.15		
.....		<b>\$436.50 EA</b> ⚠
<b>4613220XT52</b> .....	<b>49-52</b>	
Tapered for use with brake booster Small block or big block. 12.803 -0.15		
.....		<b>\$435.00 EA</b> ⚠

**Firewall (Steel) -Chevy Truck W/ V8**



<b>3693009S54</b> .....	<b>.47-54</b>	
Kit w/ set back. Smooth for V8. Use with front floor kit #3686335b54 or stock floor. 16.545 -0.15		
.....		<b>\$433.29 EA</b> ⚠
<b>3693009SC</b> .....	<b>.47-54</b>	
Kit w/ set back. Smooth curved for V8. 16.545 -0.15		
.....		<b>\$450.50 EA</b> ⚠

**Smooth Firewall Bead Rolled (Steel) -Chevy Truck**



<b>4754KA</b> .....	<b>.47-54</b>	
2 panels. Firewall Filler Panels are designed to be easily installed by the DIY or a professional. The Firewall Panels are laser cut from 18 gauge steel 1.000 -0		
.....		<b>\$140.00 EA</b> ⚠

Returns require a return authorization number—Please call first. · Note: Product pricing and availability subject to change.



**Smooth Firewall Bead Rolled (Steel) -Chevy Truck, cont.**



**4754TR** .....47-54  
2 panels. Firewall Filler Panels are designed to be easily installed by the DIY or a professional. The Firewall Panels are laser cut from 18 gauge steel 1.000 -0 ..... **\$140.00 EA** ⚠



**5559TR** .....55-59  
2 panels. Firewall Filler Panels are designed to be easily installed by the DIY or a professional. The Firewall Panels are laser cut from 18 gauge steel -0 ..... **\$140.00 EA** ⚠



**6066TR** .....60-66  
2 panels. Firewall Filler Panels are designed to be easily installed by the DIY or a professional. The Firewall Panels are laser cut from 18 gauge steel -0 ..... **\$140.00 EA** ⚠

**Floorboards - Front Chevy Car**

**4132412X39** .....37-39  
Fabricated. Small block 12.980 -0.15 ..... **\$251.75 SET** ⚠  
**4132412Y39** .....37-39  
Fabricated. Big block 12.980 -0.15 ..... **\$270.00 SET** ⚠

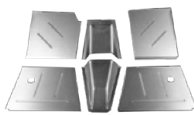

**4132412Z39** ...37-39  
Fabricated. Stock firewall 12.980 -0.15 ..... **\$270.00 SET** ⚠

**4132412X40** ..... 40  
Fabricated. Small block 12.980 -0.15 ..... **\$285.99 EA** ⚠  
**4132412Y40** ..... 40  
Fabricated. Big block 12.980 -0.15 ..... **\$285.99 EA** ⚠  
**4132412Z40** ..... 40  
Fabricated. Stock firewall 12.980 -0.15 ..... **\$286.00 EA** ⚠  
**4132412X48** .....41-48  
Fabricated. Small block 12.980 -0.15 ..... **\$285.99 EA** ⚠  
**4132412Y48** .....41-48  
Fabricated. Big block 12.980 -0.15 ..... **\$286.00 EA** ⚠

**Floorboards - Front Chevy Car, cont.**

**4132412Z48** .....41-48  
Fabricated. Stock firewall 12.980 -0.15 ..... **\$285.99 EA** ⚠  
**413241CX48** .....41-48  
Small block, CBL 12.980 -0.15 ..... **\$286.00 EA** ⚠  
**413241CY48** .....41-48  
Fabricated. Big block, CBL 12.980 -0.15 ..... **\$286.00 EA** ⚠  
**4583665X52** .....49-52  
Bitchen Style. Small or big block, to rear seat riser 12.980 -0.15 ..... **\$318.89 EA** ⚠

**Floorboards - Center Chevy Car**

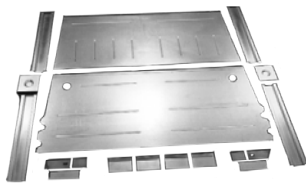

**4132413V39** .....37-39  
Fabricated. 2-door & 4-door sedans. 12.980 -0.15 ..... **\$290.75 EA** ⚠  
**4132413V48** .....41-48  
Fabricated. 2-door & 4-door sedans. 12.980 -0.15 ..... **\$425.00 EA** ⚠  
**4132413W48** .....41-48  
Fabricated. Coupe 12.980 -0.15 ..... **\$450.00 EA** ⚠

**Floorboards - Rear Chevy Car**

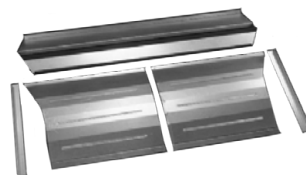

**4132414V39** .....37-39  
Fabricated. 2/4 door sedans. Includes rear seat riser, the rise over the axle. 12.980 -0.15 ..... **\$230.50 EA** ⚠  
**4132414W39** .....37-39  
Fabricated. Coupe 12.980 -0.15 ..... **\$285.75 SET** ⚠  
**4132414V48** .....41-48  
Fabricated. 2-door & 4-door sedans. 12.980 -0.15 ..... **\$355.00 EA** ⚠  
**4132414W48** .....41-48  
Fabricated. Coupe 12.980 -0.15 ..... **\$395.00 EA** ⚠

**Floorboard For C5 Rear Subframe**

**C5FLOOR** .....41-48  
This is a complete floorboard for 1941-48 cars with C5 rear subframe. The driveline tunnel is large enough to fit over C5 torque tube. -0.2 ..... **\$1,375.00 EA** ⚠

**Trunk Floor Repair Panels -Chevy**

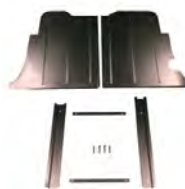

**4117487T48** ...41-48  
Fabricated. Coupe, Sedan & Cabriolet. Includes braces to support the trunk floor. 12.980 -0.15 ..... **\$167.50 EA** ⚠

**Floor Kit - Chevy Truck**



**3686335B54** .....47-54  
Front floor panels with toe board. For use with direct sheetmetal firewall  
**#3693009S54**. 0.000 -0.15 ..... **\$314.75 SET** ⚠

**Toe Board Bead Rolled**



**4754TB** .....47-54  
These Toe Boards give the ultimate custom

and clean look to finish off the engine bay. The Toe Boards are laser cut from 18 gauge steel and are to be used as a replacement part for the original toe boards. All holes for pedals, wiring etc. will need to be cut by the installer. -0

..... **\$200.00 SET** ⚠



**5559TB** .....55-59

These Toe Boards give the ultimate custom and clean look to finish off the engine bay. The Toe Boards are laser cut from 18 gauge steel and are to be used as a replacement part for the original toe boards. All holes for pedals, wiring etc. will need to be cut by the installer. -0

..... **\$200.00 SET** ⚠



**6066TB** .....60-66

These Toe Boards give the ultimate custom and clean look to finish off the engine bay. The Toe Boards are laser cut from 18 gauge steel and are to be used as a replacement part for the original toe boards. All holes for pedals, wiring etc. will need to be cut by the installer. -0

..... **\$200.00 SET** ⚠



**WARNING: Cancer and Reproductive Harm** —  
www.P65Warnings.ca.gov

NOTE: Any chemicals will be shipped domestic ground only (Lower 48 states only). No international shipping.

**Radiator Core Support -Chevy**



**3684764**.....**47-53**  
For Chevy Trucks. Allows you to adjust your radiator up and down, side to side to get the fit you want. The radiator can be mounted up to 2-1/4" lower than stock which will allow the use of an engine mounted fan. 16.545 -0.15 **\$420.00 KIT**

**3684764B**.....**54-55**  
For Chevy Trucks. Allows you to adjust your radiator up and down, side to side to get the fit you want. The radiator can be mounted up to 2-1/4" lower than stock which will allow the use of an engine mounted fan. 16.545 -0.15 **\$360.00 EA**

**Inner Fender Kit - Chevy & GMC Truck**

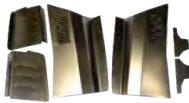

**3686239**.....**47-54**  
Inner fender Apron Kit. Cleans look of engine bay. Bolt-in.

Stock or Smooth firewalls/ core supports. 16.545 -0.15 **\$415.00 SET**

**Cowl Vent Filler Panel -Chevy Trucks**



**3683004A53**.....**47-53**  
Weld in panel to delete vent. 16.545 -0.15 **\$24.00 EA**



**3683004B54**.....**54**  
Weld in panel to delete vent. 16.545 -0.3 **\$18.00 EA**

**Power Cowl Vent Kit**



**WASL34**.....**ALL**  
Give your cowl vent a lift with this powerful gear motor kit that comes complete with gear motor, brackets, hardware, interior switch, wire, connectors and instructions. Steel bracket for cowl can be bolted or welded. Attractive 5" aluminum rod arm gives a clean look. Motor with mounting bracket and lever arm measure 2-1/2" wide, 4" high and 3-1/4" deep including motor, not including 5" connecting arm. Also works for power glove box door. Not waterproof. -0.15 **\$109.25 SET**

**Running Boards -Chevy Car**

**602913C**.....**37-38**  
Smooth fiberglass. 8.299 -0.15 **\$530.00 L&R**

**602913S**.....**37-38**  
Fabricated. Smooth 16ga.cold rolled steel. 8.299 -0.15 **\$575.75 L&R**

**603957C**.....**39**  
Smooth fiberglass. 8.299 -0.15 **\$529.00 L&R**



**603957S**.....**39**  
Smooth 16ga.cold rolled steel. 8.299 -0.15 **\$570.75 L&R**



**Running Boards for 2in. Wider Rear Fenders -Chevy Car**

**602913CW**.....**37-38**  
Smooth fiberglass. 8.299 -0.15 **\$486.00 L&R**

**Running Boards for 2in. Wider Rear Fenders -Chevy Car, cont.**



**602913SW**.....**37-38**  
Fabricated. Smooth 16ga.cold rolled steel. 8.299 -0.15 **\$590.25 L&R**

**603957CW**.....**39**  
Smooth fiberglass. 8.299 -0.15 **\$529.00 L&R**



**603957SW**.....**39**  
Fabricated. Smooth 16ga.cold rolled steel. 8.299 -0.15 **\$590.25 L&R**

**3653587CW**.....**40**  
Smooth fiberglass. 8.299 -0.15 **\$529.00 PR**



**3653587SW**.....**40**  
Fabricated. Smooth 16ga.cold rolled steel. 7.016 -0.15 **\$590.25 L&R**

**Running Boards w/ Built-in Mounting Points (Fiberglass) -Chevy Truck**

**594265W**.....**37-38**  
Fiberglass-smooth 1/2Ton (2 in. wider). 8.299 -0.15 **\$545.00 PR**

**594266F**.....**37-38**  
Fiberglass-smooth 1/2Ton. 8.299 -0.15 **\$558.00 PR**

**599578FS**.....**39-40**  
Fiberglass-smooth 1/2Ton. 8.299 -0 **CALL**

**599578FW**.....**39-40**  
Fiberglass-smooth 1/2Ton (2 in. wider). 8.299 -0 **CALL**

**3656702F**.....**41-46**  
Fiberglass-smooth 1/2Ton. 8.299 -0 **CALL**



**Running Boards w/ Built-in Mounting Points (Fiberglass) -Chevy Truck, cont.**

- 3656702T** .....41-46  
Fiberglass-stock 1/2Ton. 8.299 -0.15  
..... **\$572.00 PR** ⚠
- 3656915FS** .....41-46  
Fiberglass-smooth 3/4Ton long bed.  
8.299 -0  
..... **CALL** ⚠
- 3656915FW** .....41-46  
Fiberglass -2" wider-smooth 3/4Ton long  
bed. 8.299 -0.15  
..... **\$560.00 PR** ⚠



- 3682721S** .....47-54  
Fiberglass-smooth 1/2T. 8.299 -0.15  
..... **\$545.00 PR** ⚠



- 3682721W** .....47-54  
Fiberglass-smooth 1/2T (2in. wider).  
8.299 -0.15 ..... **\$545.00 PR** ⚠

**Running Boards w/ Built-in Mounting Points (Steel) -Chevy Truck**

- 594266SW** .....37-38  
Fabricated. Smooth 16ga.cold rolled  
steel. 1/2Ton (2 in. wider). 8.299 -0.15  
..... **\$619.00 PR** ⚠
- 599578S** .....39-40  
Fabricated. Smooth 16ga.cold rolled  
steel. 1/2Ton. 8.299 -0.15 .. **\$599.50 PR**  
⚠
- 599578SW** .....39-40  
Fabricated. Smooth 16ga.cold rolled  
steel. 1/2Ton (2 in. wider). 8.299 -0.15  
..... **\$618.89 PR** ⚠
- 3656702S** .....41-46  
Fabricated. Smooth 16ga.cold rolled  
steel. 1/2Ton. 8.299 -0.15 .. **\$600.50 PR**  
⚠
- 3682721S** .....47-54  
Fabricated. Smooth 16ga.cold rolled  
steel. 1/2Ton. 8.299 -0.15 .. **\$600.49 PR**  
⚠

**Transmission Cover - Chevy**

- 36503870S** .....37-39  
Trans Cover, Automatic Oversized 12.565 -0  
..... **\$144.75 EA** ⚠



- 3650387T39** .....37-39  
Fabricated. For auto transmission.  
12.565 -0.15 ..... **\$159.75 EA** ⚠



- 3650387U40** ..... 40  
Fabricated. For auto transmission.  
12.565 -0.15 ..... **\$160.00 EA** ⚠

- 36528810S** ..... 40  
Trans cover, Automatic Oversized 12.565 -0  
..... **\$145.00 EA** ⚠



- 3650387V48** .....41-48  
Fabricated. For auto transmission.  
12.565 -0.15 ..... **\$159.75 EA** ⚠

- 36580870S** ..... 41-48  
Trans cover, Automatic Oversized 12.565 -0  
..... **\$144.75 EA** ⚠

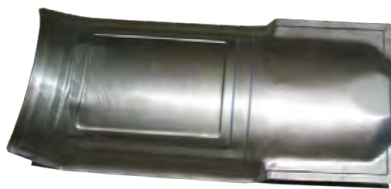

- 3688985** .....49-52  
Die-stamped. 12.565 -0.15  
..... **\$174.75 EA** ⚠

**Transmission Cover - Universal**

- 36503870S** ..... ALL  
Trans Cover, Universal Automatic  
Oversized 12.565 -0 ... **\$144.75 EA** ⚠

**MAG DADDY - Universal Magnetic Clips**

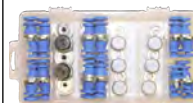

- MDU-DOORTRIM** . .ALL  
Mag Daddy Universal  
Door Panel / Trim Kit  
8.950 -0.15  
..... **\$79.99 SET** ⚠



- MDU-GD** .....ALL  
Mag Daddy Universal  
glue style magnet - 3  
pack Great for door  
panels or trim pieces. 8.950 -0.15  
..... **\$13.59 SET** ⚠



- MDU-GGD** .....ALL  
Mag Daddy Universal  
grand glue style magnet  
- 2 pack Great for door  
panels or trim pieces.  
8.950 -0.15  
..... **\$14.00 SET** ⚠



- MDU-HD** .....ALL  
Mag Daddy Universal  
heavy duty magnet - 5  
pack 8.950 -0.15  
..... **\$16.25 SET** ⚠



- MDU-LOWPRO** . . .ALL  
Mag Daddy Universal  
low proile magnet - 5  
pack 8.950 -0.15  
..... **\$12.50 SET** ⚠



- MDU-MN14** . . . . .ALL  
Mag Daddy Universal  
Max-Nut. 1/4-20 - 3  
pack 8.950 -0.15  
..... **\$15.00 SET** ⚠



- MDU-RESTOKIT** . . .ALL  
Mag Daddy Universal  
Restoration Kit  
8.950 -0.15  
..... **\$85.19 SET** ⚠



- MDU-STARTERKIT** .ALL  
Mag Daddy Universal  
Starter Kit  
8.950 -0.15  
..... **\$77.29 SET** ⚠

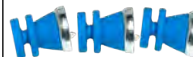

- MDU-UNIV** . . . . .ALL  
Mag Daddy Universal  
style magnetic clip. 3  
pack 8.950 -0.15  
..... **\$8.00 EA** ⚠

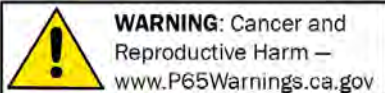

NOTE: Any chemicals will be shipped domestic ground only (Lower 48 states only). No international shipping.

# Section 310: Firewalls, Firewall Pads & Firewall Grommets

## Firewall Insulator - Buick

### 1937 BUICK SERIES 40-60 SHOWN



<b>22026</b> .....	<b>37</b>
1937 Buick Series 40-60 Firewall Insulator -0.15	<b>\$261.00</b> ⚠
<b>22027</b> .....	<b>37</b>
1937 Buick Series 80-90 Firewall Insulator (OEM Color either Black/Brown) -0.15	<b>\$276.00</b> ⚠
<b>22028</b> .....	<b>38</b>
1938 Buick Series 40-60 Firewall Insulator -0.15	<b>\$276.00</b> ⚠
<b>22029</b> .....	<b>38</b>
1938 Buick Series 80-90 Firewall Insulator -0.15	<b>\$276.00</b> ⚠
<b>22030</b> .....	<b>39</b>
1939 Buick Series 40-60 Firewall Insulator -0.15	<b>\$276.00</b> ⚠
<b>22031</b> .....	<b>39</b>
1939 Buick Series 80-90 Firewall Insulator -0.15	<b>\$276.00</b> ⚠
<b>22032</b> .....	<b>40</b>
1940 Buick Series 40-60 Firewall Insulator -0.15	<b>\$276.00</b> ⚠
<b>22033</b> .....	<b>40</b>
1940 Buick Series 50-70 Firewall Insulator -0.15	<b>\$276.00</b> ⚠
<b>22034</b> .....	<b>40</b>
1940 Buick Series 80-90 Firewall Insulator -0.15	<b>\$276.00</b> ⚠
<b>22035</b> .....	<b>41</b>
1941 Buick Series 40-60 Firewall Insulator -0.15	<b>\$276.00</b> ⚠
<b>22036</b> .....	<b>41</b>
1941 Buick Model 44A Firewall Insulator -0.15	<b>\$276.00</b> ⚠
<b>22037</b> .....	<b>41</b>
1941 Buick Series 50-70 Firewall Insulator -0.15	<b>\$276.00</b> ⚠
<b>22038</b> .....	<b>41</b>
1941 Buick Series 80-90 Firewall Insulator -0.15	<b>\$276.00</b> ⚠
<b>22039</b> .....	<b>42</b>
1942 Buick Series 40-60 Firewall Insulator -0.15	<b>\$276.00</b> ⚠
<b>22040</b> .....	<b>42-48</b>
1942-1948 Buick Series 40 Firewall Insulator (OEM Color Black) -0.15	<b>\$276.00</b> ⚠
<b>22041</b> .....	<b>42-48</b>
1942-1948 Buick Series 50-70 Firewall Insulator (OEM Color Black) -0.15	<b>\$298.75</b> ⚠
<b>22042</b> .....	<b>49</b>
1949 Buick Series 50-70 Firewall Insulator -0.15	<b>\$276.00</b> ⚠

## Firewall Insulator - Buick, cont.

<b>22043</b> .....	<b>50</b>
1950 Buick Series 50 Only Firewall Insulator (OEM Color Black) -0.15	<b>\$276.00</b> ⚠
<b>22044</b> .....	<b>50-53</b>
1950-1953 Buick Firewall Insulator All Series (except 50 Series) (OEM Color Black) -0.15	<b>\$255.00</b> ⚠
<b>22045</b> .....	<b>51-53</b>
1951-1953 Buick Super-Roadmaster Firewall Insulator (OEM Color Black) -0.15	<b>\$276.00</b> ⚠
<b>22046</b> .....	<b>53</b>
1953 Buick Special/Skylark/Century Firewall Insulator -0.15	<b>\$276.00</b> ⚠
<b>22047</b> .....	<b>54-55</b>
1954-1955 Buick Special-Century-Skylark Firewall Insulator (OEM Color Black) -0.15	<b>\$276.00</b> ⚠
<b>22048</b> .....	<b>54-55</b>
1954-1955 Buick Roadmaster Firewall Insulator (OEM Color Black) -0.15	<b>\$276.00</b> ⚠
<b>22049</b> .....	<b>56</b>
1956 Buick Special-Century Firewall Insulator (OEM Color Black) -0.15	<b>\$276.00</b> ⚠
<b>22050</b> .....	<b>56</b>
1956 Buick Super Roadmaster Firewall Insulator (OEM Color Black) -0.15	<b>\$276.00</b> ⚠
<b>22051</b> .....	<b>57-58</b>
1957-1958 Buick Special-Century-Super Firewall Insulator (OEM Color Black) -0.15	<b>\$276.00</b> ⚠
<b>22052</b> .....	<b>59-60</b>
1959-1960 Buick Model 4439 Firewall Insulator (OEM Color Black) -0.15	<b>\$226.00</b> ⚠
<b>22053</b> .....	<b>61-62</b>
1961-1962 Buick Electra/Invicta (A) Firewall Insulator (OEM Color Black) -0.15	<b>\$226.00</b> ⚠
<b>22054</b> .....	<b>61-62</b>
1961-1962 Buick Special-Skylark Firewall Insulator (OEM Color Black) -0.15	<b>\$226.00</b> ⚠
<b>22055</b> .....	<b>63-64</b>
1963-1964 Buick Electra Firewall Insulator (OEM Color Black) (Ultra High Def. Rubber) -0.15	<b>\$179.00</b> ⚠
<b>22056</b> .....	<b>63-64</b>
1963-1964 Buick Wildcat Firewall Insulator with Air Conditioning. (Ultra High Def. Rubber) -0.15	<b>\$179.00</b> ⚠
<b>22057</b> .....	<b>63-65</b>
1963-1965 Buick Riviera Firewall Insulator (Ultra High Def. Rubber) -0.15	<b>\$179.00</b> ⚠

## Firewall Insulator - Cadillac

### 1937 CADILLAC SERIES 60 SHOWN



<b>22058</b> .....	<b>36-37</b>
1936-1937 Cadillac Fleetwood V-12 Flat Firewall Insulator -0.15	<b>\$243.00</b> ⚠
<b>22059</b> .....	<b>37</b>
1937 Cadillac Series 60 Flat Firewall Insulator -0.15	<b>\$226.00</b> ⚠
<b>22060</b> .....	<b>37</b>
1937 Cadillac Series 75-85 Flat Firewall Insulator -0.15	<b>\$220.49</b> ⚠
<b>22061</b> .....	<b>37</b>
1937 Cadillac Series 75 Special Flat Firewall Insulator -0.15	<b>\$211.00</b> ⚠
<b>22062</b> .....	<b>38</b>
1938 Cadillac Series 60 Special Firewall Insulator -0.15	<b>\$211.00</b> ⚠
<b>22063</b> .....	<b>38-39</b>
1938-1939 Cadillac Series 90 Firewall Insulator -0.15	<b>\$211.00</b> ⚠
<b>22064</b> .....	<b>39</b>
1939 Cadillac Series 60 Special Firewall Insulator (OEM Color either Black or Brown) -0.15	<b>\$211.00</b> ⚠
<b>22065</b> .....	<b>39</b>
1939 Cadillac Series 61 Firewall Insulator -0.15	<b>\$188.00</b> ⚠
<b>22066</b> .....	<b>39-40</b>
1939-1940 Cadillac Series 75-90 Firewall Insulator -0.15	<b>\$211.00</b> ⚠
<b>22067</b> .....	<b>40</b>
1940 Cadillac Series 50 Firewall Insulator -0.15	<b>\$188.00</b> ⚠
<b>22068</b> .....	<b>40</b>
1940 Cadillac Series 62 Molded Firewall Insulator -0.15	<b>\$226.00</b> ⚠
<b>22069</b> .....	<b>40-41</b>
1940-1941 Cadillac Series 60 Special Firewall Insulator -0.15	<b>\$226.00</b> ⚠
<b>22070</b> .....	<b>41</b>
1941 Cadillac Series 61 Firewall Insulator -0.15	<b>\$276.00</b> ⚠
<b>22071</b> .....	<b>41</b>
1941 Cadillac Series 62 Firewall Insulator -0.15	<b>\$276.00</b> ⚠
<b>22072</b> .....	<b>41</b>
1941 Cadillac Series 75 Firewall Insulator -0.15	<b>\$276.00</b> ⚠
<b>22073</b> .....	<b>42-47</b>
1942-1947 Cadillac Model 61 Firewall Insulator -0.15	<b>\$276.00</b> ⚠
<b>22074</b> .....	<b>42-47</b>
1942-1947 Cadillac Series 62 Molded Firewall Insulator (Type 1) -0.15	<b>\$276.00</b> ⚠

Returns require a return authorization number—Please call first. • Note: Product pricing and availability subject to change.



**WARNING:** Cancer and Reproductive Harm — [www.P65Warnings.ca.gov](http://www.P65Warnings.ca.gov)

**Firewall Insulator - Cadillac, cont.**

22075.....	42-47
1942-1947 Cadillac Series 62 Molded Firewall Insulator (Type 2) -0.15	\$276.00 ⚠
22076.....	42-47
1942-1947 Cadillac Model 75 Firewall Insulator -0.15	\$276.00 ⚠
22077.....	48
1948 Cadillac Series 61-62 Firewall Insulator -0.15	\$276.00 ⚠
22078.....	48
1948 Cadillac Model 75 Firewall Insulator -0.15	\$243.00 ⚠
22079.....	49
1949 Cadillac Series 62 Firewall Insulator -0.15	\$243.00 ⚠
22080.....	49
1949 Cadillac Series 75 Firewall Insulator -0.15	\$243.00 ⚠
22081.....	50-52
1950-1952 Cadillac Firewall Insulator -0.15	\$243.00 ⚠
22082.....	53
1953 Cadillac Firewall Insulator -0.15	\$276.00 ⚠
22083.....	54
1954 Cadillac Firewall Insulator w/Cowl Cover -0.15	\$276.00 ⚠
22084.....	55
1955 Cadillac Firewall Insulator w/Cowl Cover -0.15	\$276.00 ⚠
22085.....	56
1956 Cadillac Firewall Insulator w/Cowl Cover -0.15	\$276.00 ⚠
22086.....	57-58
1957-1958 Cadillac Eldorado Brougham Firewall Insulator -0.15	\$276.00 ⚠
22087.....	57-58
1957-1958 Cadillac Firewall Insulator -0.15	\$276.00 ⚠
22088.....	59
1959 Cadillac Firewall Insulator -0.15	\$276.00 ⚠
22089.....	60
1960 Cadillac Firewall Insulator -0.15	\$276.00 ⚠
22090.....	61
1961 Cadillac Model 6267 Firewall Insulator -0.15	\$276.00 ⚠
22091.....	62
1962 Cadillac Model 6039 Firewall Insulator -0.15	\$276.00 ⚠
22092.....	63-64
1963-1964 Cadillac Firewall Insulator -0.15	\$276.00 ⚠

**Firewall Insulator - Chevrolet**

**1937-38 CHEVY SHOWN**



594350A.....	37-38
Car 15.280 -0.15	\$237.75 EA ⚠
594350BB.....	37-40
Car, fits street rod big block firewall #4091695Y39. 15.280 -0.15	\$229.00 EA ⚠
594350SB.....	37-40
Car, Fits street rod small block firewall #4091695X39. 15.280 -0.15	\$239.49 EA ⚠
3693007.....	37-46
Truck 16.802 -0.15	\$212.50 EA ⚠
350627A.....	39
Car 15.280 -0.15	\$246.50 EA ⚠
3658461A.....	40-41
Car 15.280 -0.15	\$246.50 EA ⚠
3658131BB.....	41-48
Car, fits street rod big block firewall #4117580Y48. 15.280 -0.15	\$239.50 EA ⚠
3658131SB.....	41-48
Car, fits street rod small block firewall #4117580X48. 15.280 -0.15	\$239.49 EA ⚠
3658131A.....	42-48
Car 15.280 -0.15	\$236.50 EA ⚠
3693009.....	47-54
Truck 16.802 -0.15	\$212.50 EA ⚠
3693009B.....	47-54
Truck, fits Street Rod-style firewall #3693009S54. 16.802 -0.15	\$229.00 EA ⚠
3702869.....	47-54
Truck, No holes. 16.802 -0.15	\$195.39 EA ⚠
3693817A.....	49-50
Car 15.280 -0.15	\$271.50 EA ⚠
3697873A.....	53-54
Car 15.280 -0.15	\$272.00 EA ⚠
22093.....	55
1955 Chevrolet Car Firewall Insulator -0.15	\$261.00 ⚠
22094.....	55-59
1955-59 Chevy Truck Firewall Insulator -0.15	\$194.00 ⚠
22095.....	56
1956 Chevrolet Car Firewall Insulator -0.15	\$261.00 ⚠
22096.....	57
1957 Chevrolet Car Firewall Insulator (ABS Plastic) -0.15	\$261.00 ⚠
22097.....	58
1958 Chevrolet Firewall Insulator -0.15	\$261.00 ⚠

**Firewall Insulator - Chevrolet, cont.**

22098.....	59-60
1959-1960 Chevrolet-El Camino Firewall Insulator -0.15	\$261.00 ⚠
22099.....	60-63
1960-63 Chevy Truck Firewall Insulator -0.15	\$194.00 ⚠
22100.....	61-62
1961-1962 Chevrolet Firewall Insulator -0.15	\$276.00 ⚠
22101.....	63-64
1963-1964 Chevrolet Firewall Insulator -0.15	\$261.00 ⚠

**Firewall Insulator - Dodge**

**1951-52 DODGE SHOWN**



22102.....	37
1937 Dodge D-2 Firewall Insulator -0.15	\$244.00 ⚠
22103.....	37
1937 Dodge D-5 Firewall Insulator -0.15	\$244.00 ⚠
22104.....	37-38
1937-1938 Dodge Truck Firewall Insulator with Setback -0.15	\$212.00 ⚠
22105.....	38
1938 Dodge D-8 Firewall Insulator -0.15	\$244.00 ⚠
22106.....	39-42
1939-1942 Dodge D-10 Firewall Insulator -0.15	\$277.00 ⚠
22107.....	39-47
1939-1947 Dodge Truck Molded Firewall Insulator -0.15	\$212.00 ⚠
22108.....	40-42
1940-1942 Dodge D-8 Firewall Insulator -0.15	\$277.00 ⚠
22109.....	48-53
1948-1953 Dodge Truck Firewall Insulator -0.15	\$244.00 ⚠
22110.....	51-52
1951-1952 Dodge Firewall Insulator (ABS Plastic) -0.15	\$277.00 ⚠
22111.....	53-54
1953-1954 Dodge Car Firewall Insulator (ABS Plastic) -0.15	\$244.00 ⚠
22112.....	54-60
1954-1960 Dodge Truck Firewall Insulator -0.15	\$195.00 ⚠



NOTE: Any chemicals will be shipped domestic ground only (Lower 48 states only). No international shipping.



**Firewall Insulator - Ford**

**1957-58 FORD SHOWN**



<b>22115</b> .....	<b>37</b>
1937 Ford Standard Firewall With Battery Box -0.15 .....	<b>\$267.00</b> ⚠
<b>22116</b> .....	<b>37-39</b>
1937-39 Ford Truck Firewall Insulator with Battery Box -0.15 ...	<b>\$267.00</b> ⚠
<b>22117</b> .....	<b>39</b>
1939 Ford Deluxe Firewall Insulator -0.15 .....	<b>\$267.00</b> ⚠
<b>22118</b> .....	<b>40</b>
1940 Ford Deluxe Firewall Insulator -0.15 .....	<b>\$267.00</b> ⚠
<b>22119</b> .....	<b>40-47</b>
1940-47 Ford Truck Firewall Insulator -0.15 .....	<b>\$199.00</b> ⚠
<b>22120</b> .....	<b>41</b>
1941 Ford Standard Firewall Insulator -0.15 .....	<b>\$216.00</b> ⚠
<b>22121</b> .....	<b>41</b>
1941 Ford Deluxe Firewall Insulator -0.15 .....	<b>\$267.00</b> ⚠
<b>22122</b> .....	<b>42-48</b>
1942-1948 Ford/Mercury Firewall Insulator -0.15 .....	<b>\$216.00</b> ⚠
<b>22123</b> .....	<b>48-50</b>
1948-1950 Ford COE Firewall Insulator -0.15 .....	<b>\$199.00</b> ⚠
<b>22124</b> .....	<b>48-52</b>
1948-52 Ford Truck Firewall Insulator -0.15 .....	<b>\$199.00</b> ⚠
<b>22125</b> .....	<b>48-52</b>
1948-52 Ford F/3 Truck Firewall Insulator -0.15 .....	<b>\$199.00</b> ⚠
<b>22126</b> .....	<b>52-54</b>
1952-54 Ford/Mercury Firewall Insulator -0.15 .....	<b>\$278.59</b> ⚠
<b>22127</b> .....	<b>53-55</b>
1953-55 Ford Truck Firewall Insulator -0.15 .....	<b>\$199.00</b> ⚠
<b>22128</b> .....	<b>53-55</b>
1953-1955 Ford Truck 800 Firewall Insulator -0.15 .....	<b>\$185.00</b> ⚠
<b>22129</b> .....	<b>53-56</b>
1953-56 Ford/Mercury F-250 Firewall Insulator -0.15 .....	<b>\$232.00</b> ⚠
<b>22130</b> .....	<b>53-56</b>
1953-1956 Ford/Mercury Canadian F-250 Truck Firewall Insulator -0.15 .....	<b>\$199.00</b> ⚠
<b>22131</b> .....	<b>55-56</b>
1955-1956 Ford Firewall Insulator -0.15 .....	<b>\$267.00</b> ⚠
<b>22132</b> .....	<b>56</b>
1956 Ford Truck Firewall Insulator -0.15 .....	<b>\$199.00</b> ⚠

**Firewall Insulator - Ford**

<b>22133</b> .....	<b>56</b>
1956 Ford Truck 800 Firewall Insulator -0.15 .....	<b>\$185.00</b> ⚠
<b>22134</b> .....	<b>57-58</b>
1957-1958 Ford Car Firewall Insulator -0.15 .....	<b>\$232.00</b> ⚠
<b>22135</b> .....	<b>57-60</b>
1957-1960 Ford Truck Firewall Insulator -0.15 .....	<b>\$199.00</b> ⚠
<b>22136</b> .....	<b>59</b>
1959 Ford Car (Molded) Firewall Insulator -0.15 .....	<b>\$232.00</b> ⚠
<b>22137</b> .....	<b>60-62</b>
1960-1962 Ford Car Firewall Insulator -0.15 .....	<b>\$183.00</b> ⚠
<b>22114</b> .....	<b>60-63</b>
1960-1963 Falcon Firewall Insulator (Ultra High Def. Rubber) -0.15 .....	<b>\$183.00</b> ⚠
<b>22138</b> .....	<b>61-64</b>
1961-1964 Ford Truck 2WD F-100 Firewall Insulator -0.15 .....	<b>\$199.00</b> ⚠
<b>22113</b> .....	<b>62-64</b>
1962-1964 Fairlane/Torino Firewall Insulator (Ultra High Def. Rubber) -0.15 .....	<b>\$183.00</b> ⚠
<b>22139</b> .....	<b>63-64</b>
1963-1964 Ford Car Firewall Insulator -0.15 .....	<b>\$183.00</b> ⚠

**Firewall Insulator - Lincoln**

**1937 LINCOLN ZEPHYR SHOWN**



<b>22140</b> .....	<b>37</b>
1937 Lincoln Zephyr Firewall Insulator -0.15 .....	<b>\$283.00</b> ⚠
<b>22141</b> .....	<b>38-39</b>
1938-39 Lincoln Zephyr Firewall Insulator -0.15 .....	<b>\$231.00</b> ⚠
<b>22142</b> .....	<b>40-41</b>
1940-1941 Lincoln Zephyr Firewall Insulator -0.15 .....	<b>\$283.00</b> ⚠
<b>22143</b> .....	<b>42-48</b>
1942-1948 Lincoln Continental Firewall Insulator -0.15 .....	<b>\$231.00</b> ⚠
<b>22144</b> .....	<b>42-48</b>
1942-1948 Lincoln Zephyr Molded Firewall Insulator -0.15 .....	<b>\$283.00</b> ⚠
<b>22145</b> .....	<b>49-51</b>
1949-1951 Lincoln Cosmopolitan Firewall Insulator -0.15 .....	<b>\$232.00</b> ⚠
<b>22146</b> .....	<b>49-51</b>
1949-1951 Baby Lincoln Molded Firewall Insulator -0.15 .....	<b>\$216.00</b> ⚠
<b>22147</b> .....	<b>52-55</b>
1952-1955 Lincoln Firewall Insulator -0.15 .....	<b>\$249.00</b> ⚠

**Firewall Insulator - Lincoln, cont.**

<b>22148</b> .....	<b>56</b>
1956 Lincoln Continental Mark II Firewall Insulator -0.15 .....	<b>\$193.00</b> ⚠
<b>22149</b> .....	<b>56-57</b>
1956-1957 Lincoln Firewall Insulator -0.15 .....	<b>\$249.00</b> ⚠

**Firewall Insulator - Mercury**



<b>22150</b> .....	<b>39</b>
1939 Mercury Car Firewall Insulator (ABS Plastic) -0.15 .....	<b>\$267.00</b> ⚠
<b>22151</b> .....	<b>40</b>
1940 Mercury Car Firewall Insulator (ABS Plastic) -0.15 .....	<b>\$267.00</b> ⚠
<b>22152</b> .....	<b>41</b>
1941 Mercury Car Firewall Insulator (ABS Plastic) -0.15 .....	<b>\$267.00</b> ⚠
<b>22153</b> .....	<b>42-48</b>
1942-1948 Mercury Car Firewall Insulator (ABS Plastic) -0.15 .....	<b>\$216.00</b> ⚠
<b>22154</b> .....	<b>49</b>
1949 Mercury Car Firewall Insulator -0.15 .....	<b>\$267.00</b> ⚠
<b>22155</b> .....	<b>52-54</b>
1952-1954 Mercury Car Firewall Insulator (ABS Plastic) -0.15 .....	<b>\$267.00</b> ⚠
<b>22156</b> .....	<b>55-56</b>
1955-1956 Mercury Car Firewall Insulator (ABS Plastic) -0.15 .....	<b>\$267.00</b> ⚠

**Firewall Insulator - Mopar**

**1951-52 DODGE SHOWN**



<b>22157</b> .....	<b>53-54</b>
1953-1954 Mopar Firewall Insulator -0.15 .....	<b>\$277.00</b> ⚠
<b>22158</b> .....	<b>55-56</b>
1955-56 Mopar Car Firewall Insulator -0.15 .....	<b>\$244.00</b> ⚠
<b>22159</b> .....	<b>57-59</b>
1957-1959 Mopar Firewall Insulator (ABS Plastic) (OEM Color Black) -0.15 .....	<b>\$277.00</b> ⚠
<b>22160</b> .....	<b>60-62</b>
1960-62 Mopar A-Body Firewall Insulator -0.15 .....	<b>\$149.00</b> ⚠

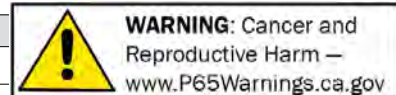

**Firewall Insulator - Oldsmobile**

1937 OLDSMOBILE SERIES 70 SHOWN



<b>22161</b> .....	<b>37</b>
1937 Oldsmobile Series 70 Firewall	
Insulator -0.15 .....	<b>\$276.00</b> ⚠
<b>22162</b> .....	<b>38</b>
1938 Oldsmobile Series 60 Firewall	
Insulator (OEM color Brown) -0.15 .....	<b>\$276.00</b> ⚠
<b>22163</b> .....	<b>39</b>
1939 Oldsmobile Series 60 Firewall	
Insulator -0.15 .....	<b>\$276.00</b> ⚠
<b>22164</b> .....	<b>40</b>
1940 Oldsmobile Series 60 Firewall	
Insulator -0.15 .....	<b>\$276.00</b> ⚠
<b>22165</b> .....	<b>40</b>
1940 Oldsmobile Series 70 Firewall	
Insulator -0.15 .....	<b>\$276.00</b> ⚠
<b>22166</b> .....	<b>41-48</b>
1941-1948 Oldsmobile Model 66 Firewall	
Insulator -0.15 .....	<b>\$226.00</b> ⚠
<b>22167</b> .....	<b>42-48</b>
1942-1948 Oldsmobile Series 70 Firewall	
Insulator -0.15 .....	<b>\$276.00</b> ⚠
<b>22168</b> .....	<b>42-48</b>
1942-1948 Oldsmobile Series 98 Firewall	
Insulator -0.15 .....	<b>\$276.00</b> ⚠
<b>22169</b> .....	<b>49-51</b>
1949-1951 Oldsmobile Series 88 Firewall	
Insulator -0.15 .....	<b>\$276.00</b> ⚠
<b>22170</b> .....	<b>50</b>
1950 Oldsmobile Series 98 Firewall	
Insulator -0.15 .....	<b>\$276.00</b> ⚠
<b>22171</b> .....	<b>52</b>
1952 Oldsmobile Super 88-98 Firewall	
Insulator -0.15 .....	<b>\$276.00</b> ⚠
<b>22172</b> .....	<b>53</b>
1953 Oldsmobile Series 88 Firewall	
Insulator -0.15 .....	<b>\$276.00</b> ⚠
<b>22173</b> .....	<b>53</b>
1953 Oldsmobile 98 Fiesta Firewall	
Insulator -0.15 .....	<b>\$276.00</b> ⚠
<b>22174</b> .....	<b>54</b>
1954 Oldsmobile 88/98 Firewall	
Insulator -0.15 .....	<b>\$276.00</b> ⚠
<b>22175</b> .....	<b>55-56</b>
1955-1956 Oldsmobile 88-98 Firewall	
Insulator -0.15 .....	<b>\$276.00</b> ⚠
<b>22176</b> .....	<b>57</b>
1957 Oldsmobile 88-98 Firewall Insulator	
With Speaker Panel -0.15 .....	<b>\$226.00</b> ⚠
<b>22177</b> .....	<b>58</b>
1959 Oldsmobile 88-98 Firewall	
Insulator -0.15 .....	<b>\$226.00</b> ⚠
<b>22178</b> .....	<b>61-62</b>
1961-1962 Oldsmobile 88-98 Firewall	
Insulator -0.15 .....	<b>\$243.00</b> ⚠

**Firewall Insulator - Oldsmobile, cont.**

<b>22179</b> .....	<b>63-64</b>
1963-1964 Oldsmobile Firewall	
Insulator -0.15 .....	<b>\$161.00</b> ⚠
<b>22180</b> .....	<b>63-64</b>
1963-1964 Oldsmobile Catalina	
Convertible Firewall Insulator -0.15 .....	<b>\$161.00</b> ⚠

**Firewall Insulator - Plymouth**

1951-52 DODGE SHOWN



<b>22181</b> .....	<b>37</b>
1937 Plymouth D-2 Firewall Insulator -0.15 .....	
	<b>\$244.00</b> ⚠
<b>22182</b> .....	<b>38</b>
1938 Plymouth Firewall Insulator -0.15 .....	
	<b>\$244.00</b> ⚠
<b>22183</b> .....	<b>39</b>
1939 Plymouth P-10 Firewall	
Insulator -0.15 .....	<b>\$244.00</b> ⚠
<b>22184</b> .....	<b>39</b>
1939 Plymouth P-7 Firewall	
Insulator -0.15 .....	<b>\$244.00</b> ⚠
<b>22185</b> .....	<b>39-42</b>
1939-1942 Plymouth D-10 Firewall	
Insulator -0.15 .....	<b>\$277.00</b> ⚠
<b>22186</b> .....	<b>39-47</b>
1939-47 Plymouth Truck/COE Firewall	
Insulator -0.15 .....	<b>\$212.00</b> ⚠
<b>22187</b> .....	<b>40-42</b>
1940-1942 Plymouth P-10 Firewall	
Insulator -0.15 .....	<b>\$289.59</b> ⚠
<b>22188</b> .....	<b>42-48</b>
1942-1948 Plymouth Firewall	
Insulator -0.15 .....	<b>\$277.00</b> ⚠
<b>22189</b> .....	<b>49-50</b>
1949-1950 Plymouth P-20 Firewall	
Insulator -0.15 .....	<b>\$277.00</b> ⚠
<b>22190</b> .....	<b>49-50</b>
1949-1950 Plymouth P-40 Firewall	
Insulator -0.15 .....	<b>\$277.00</b> ⚠
<b>22191</b> .....	<b>51-52</b>
1951-1952 Plymouth Firewall Insulator	
(ABS Plastic) -0.15 .....	<b>\$277.00</b> ⚠
<b>22192</b> .....	<b>51-53</b>
1951-53 Plymouth Cranbrook Firewall	
Insulator -0.15 .....	<b>\$277.00</b> ⚠
<b>22193</b> .....	<b>52</b>
1952 Plymouth Cambridge Firewall	
Insulator -0.15 .....	<b>\$277.00</b> ⚠
<b>22194</b> .....	<b>53-54</b>
1953-54 Plymouth Firewall Insulator -0.15 .....	
	<b>\$277.00</b> ⚠

**Firewall Insulator - Pontiac**

1937 PONTIAC 26/28 SHOWN



<b>22195</b> .....	<b>37</b>
1937 Pontiac Model 26/28 Firewall (OEM Color Brown) -0.15 .....	
	<b>\$276.00</b> ⚠
<b>22196</b> .....	<b>38</b>
1938 Pontiac 6 Firewall Insulator -0.15 .....	
	<b>\$276.00</b> ⚠
<b>22197</b> .....	<b>39</b>
1939 Pontiac Model 25 Firewall	
Insulator -0.15 .....	<b>\$276.00</b> ⚠
<b>22198</b> .....	<b>39</b>
1939 Pontiac Model 26 Firewall	
Insulator -0.15 .....	<b>\$276.00</b> ⚠
<b>22199</b> .....	<b>40</b>
1940 Pontiac Model 25,26,27B Firewall	
Insulator -0.15 .....	<b>\$276.00</b> ⚠
<b>22200</b> .....	<b>40</b>
1940 Pontiac Model 29 Firewall	
Insulator -0.15 .....	<b>\$276.00</b> ⚠
<b>22201</b> .....	<b>41</b>
1941 Pontiac Model 26 & 28 Torpedo/Station Wagon Firewall (OEM Color Brown) -0.15 .....	
	<b>\$276.00</b> ⚠
<b>22202</b> .....	<b>42-48</b>
1942-1948 Pontiac Model 25 & 26 Firewall Insulator -0.15 .....	
	<b>\$276.00</b> ⚠
<b>22203</b> .....	<b>49-52</b>
1949-1952 Pontiac Firewall	
Insulator -0.15 .....	<b>\$276.00</b> ⚠
<b>22204</b> .....	<b>53-54</b>
1953-1954 Pontiac Firewall	
Insulator -0.15 .....	<b>\$276.00</b> ⚠
<b>22205</b> .....	<b>55-56</b>
1955-1956 Pontiac Firewall	
Insulator -0.15 .....	<b>\$276.00</b> ⚠
<b>22206</b> .....	<b>57</b>
1957 Pontiac Firewall Insulator -0.15 .....	
	<b>\$276.00</b> ⚠
<b>22207</b> .....	<b>58</b>
1958 Pontiac Bonneville Firewall	
Insulator -0.15 .....	<b>\$243.00</b> ⚠
<b>22208</b> .....	<b>59-60</b>
1959-1960 Pontiac Bonneville Firewall	
Insulator -0.15 .....	<b>\$243.00</b> ⚠
<b>22209</b> .....	<b>61</b>
1961 Pontiac Firewall Insulator -0.15 .....	
	<b>\$276.00</b> ⚠
<b>22210</b> .....	<b>62</b>
1962 Pontiac Firewall Insulator -0.15 .....	
	<b>\$276.00</b> ⚠
<b>22211</b> .....	<b>63-64</b>
1963-1964 Pontiac B Body Firewall	
Insulator -0.15 .....	<b>\$161.00</b> ⚠
<b>22212</b> .....	<b>63-64</b>
1963-1964 Pontiac Firewall	
Insulator -0.15 .....	<b>\$161.00</b> ⚠



NOTE: Any chemicals will be shipped domestic ground only (Lower 48 states only). No international shipping.

**Acousti-Shield Kits**

Introducing a multi-stage, automotive insulation and sound damping system to give your vehicle the quiet riding comfort found in today's new cars. AcoustiSHIELD kits are designed on current state-of-the-art auto acoustic technology, to insulate and control the noise, vibration and heat in the passenger cabin. Kits are pre-cut and come with easy-to-follow installation instructions, everything you need to do the job right.

Kits Include:

- Stage 1 Pre-Sized Sound Damper Pads
- Stage 2 Pre-Trimmed Heat Absorber / Barrier Panels, Spray Adhesive and Sealing Tape
- Complete Illustrated Installation Instruction

The first stage consists of pre-trimmed, self-adhesive, Sound Damper Pads, bonded to strategically located trouble spots on the floor pan and roof of the vehicle to control body panel vibration and noise. These spots are mapped and labeled in detailed instructions which are included in the kit.

The second stage uses a high-tech absorber/barrier material, bonded to the body panels, to both sound deaden and insulate the vehicle from radiant heat penetration from the engine and road. Each absorber panel is cut to the correct shape and contour and is mapped and labeled in the detailed instructions.

**Acousti-Shield Kits - Buick**



<b>21883</b> .....	<b>57-58</b>
1957-1958 Buick Super/Roadmaster Coupe Complete Acoustic Kit -0.15	
	<b>\$801.00</b> ⚠
<b>21884</b> .....	<b>57-58</b>
1957-1958 Buick Super/Roadmaster Convertible Complete Acoustic Kit -0.15	
	<b>\$668.00</b> ⚠
<b>21885</b> .....	<b>57-58</b>
1957-1958 Buick Super/Roadmaster Sedan Complete Acoustic Kit -0.15	
	<b>\$861.00</b> ⚠
<b>21886</b> .....	<b>63-65</b>
1963-1965 Buick Riviera Complete Kit -0.15	
	<b>\$798.00</b> ⚠

**Acousti-Shield Kits - Chevrolet**

<b>12917</b> .....	<b>37-38</b>
Fits 1937-38 Cabriolet. 15.492 -0.15	
	<b>\$666.00</b> KIT ⚠
<b>12915</b> .....	<b>37-39</b>
Fits 1937-39 2-door Sedan. 15.492 -0.15	
	<b>\$842.69</b> KIT ⚠
<b>12916</b> .....	<b>37-39</b>
Fits 1937-39 Coupe. 15.492 -0.15	
	<b>\$813.75</b> KIT ⚠
<b>12971</b> .....	<b>37-39</b>
Fits 1937-39 4-door Sedan. 15.492 -0.15	
	<b>\$902.79</b> KIT ⚠
<b>12927</b> .....	<b>37-46</b>
Fits 1937-46 Truck. 15.492 -0.15	
	<b>\$511.00</b> KIT ⚠
<b>12918</b> .....	<b>40-41</b>
Fits 1940-41 Cabriolet. 15.492 -0.15	
	<b>\$666.00</b> KIT ⚠
<b>12919</b> .....	<b>40-41</b>
Fits 1940-41 Coupe. (Exc 3 passenger coupe) 15.492 -0.15	
	<b>\$798.00</b> KIT ⚠
<b>15890</b> .....	<b>42-48</b>
Fits 1942-48 Business Coupe. 15.492 -0.15	
	<b>\$866.25</b> KIT ⚠
<b>15891</b> .....	<b>42-48</b>
Fits 1942-48 Coupe. 15.492 -0.15	
	<b>\$798.00</b> KIT ⚠
<b>12928</b> .....	<b>47-53</b>
Fits 1947-53 Truck. 15.492 -0.15	
	<b>\$565.25</b> KIT ⚠
<b>15894</b> .....	<b>47-53</b>
Fits 1947-54 SUBURBAN. 15.492 -0.15	
	<b>\$907.00</b> KIT ⚠
<b>15893</b> .....	<b>47-54</b>
Fits 1947-54 Panel Truck. 15.492 -0.15	
	<b>\$1,027.00</b> KIT ⚠
<b>12920</b> .....	<b>49-52</b>
Fits 1949-52 Styleline Sedan. 15.492 -0.15	
	<b>\$798.00</b> KIT ⚠
<b>12921</b> .....	<b>49-52</b>
Fits 1949-52 Styleline Convertible. 15.492 -0.15	
	<b>\$666.00</b> KIT ⚠
<b>12922</b> .....	<b>49-52</b>
Fits 1949-52 Styleline 4-door Sedan. 15.492 -0.15	
	<b>\$874.79</b> KIT ⚠
<b>12923</b> .....	<b>49-52</b>
Fits 1949-52 Fleetline 2-door Sedan. 15.492 -0.15	
	<b>\$813.75</b> KIT ⚠
<b>12924</b> .....	<b>49-52</b>
Fits 1949-52 Fleetline 4-door Sedan. 15.492 -0.15	
	<b>\$859.69</b> KIT ⚠
<b>12925</b> .....	<b>53-54</b>
Fits 1953-54 Coupe. 15.492 -0.15	
	<b>\$798.00</b> KIT ⚠
<b>12926</b> .....	<b>53-54</b>
Fits 1953-54 Sedan. 15.492 -0.15	
	<b>\$858.00</b> KIT ⚠
<b>15892</b> .....	<b>53-54</b>
Fits 1953-54 Convertible. 15.492 -0.15	
	<b>\$666.00</b> KIT ⚠

**Acousti-Shield Kits - Chevrolet, cont.**

<b>21887</b> .....	<b>53-54</b>
1953-54 Chevrolet Sedan Delivery Complete Kit -0.15	
	<b>\$952.00</b> ⚠
<b>21888</b> .....	<b>53-54</b>
1953-54 Chevrolet 2 Door Station Wagon Complete Kit -0.15	
	<b>\$952.00</b> ⚠
<b>21889</b> .....	<b>53-54</b>
1953-54 Chevrolet 4 Door Station Wagon Complete Kit -0.15	
	<b>\$983.00</b> ⚠
<b>15889</b> .....	<b>54-55</b>
Fits 1954-55 (1st Series) trucks. 15.492 -0.15	
	<b>\$554.00</b> KIT ⚠
<b>21890</b> .....	<b>54-55</b>
1954-55 Chevy Panel Delivery Complete Insulation Kit -0.15	
	<b>\$964.00</b> ⚠
<b>21891</b> .....	<b>54-55</b>
1954-55 Chevy Suburban Complete Kit -0.15	
	<b>\$759.00</b> ⚠
<b>21892</b> .....	<b>55</b>
1955 Chevrolet Coupe Complete Kit -0.15	
	<b>\$798.00</b> ⚠
<b>21893</b> .....	<b>55</b>
1955 Chevrolet Convertible Complete Kit -0.15	
	<b>\$666.00</b> ⚠
<b>21894</b> .....	<b>55</b>
1955 Chevrolet Nomad Complete Kit -0.15	
	<b>\$933.00</b> ⚠
<b>21895</b> .....	<b>55</b>
1955 Chevrolet Sedan Complete Kit -0.15	
	<b>\$858.00</b> ⚠
<b>21896</b> .....	<b>55</b>
1955 Chevrolet Sedan Delivery Complete Kit -0.15	
	<b>\$946.00</b> ⚠
<b>21897</b> .....	<b>55</b>
1955 Chevrolet Station Wagon Complete Kit -0.15	
	<b>\$978.00</b> ⚠
<b>21898</b> .....	<b>55-59</b>
1955-59 Chevy Panel Delivery Complete Kit -0.15	
	<b>\$964.00</b> ⚠
<b>21899</b> .....	<b>55-59</b>
1955-59 Chevy Suburban Complete Kit -0.15	
	<b>\$759.00</b> ⚠
<b>21900</b> .....	<b>55-59</b>
1955-59 Chevy Truck Complete Kit -0.15	
	<b>\$501.00</b> ⚠
<b>21901</b> .....	<b>56</b>
1956 Chevrolet Coupe Complete Kit -0.15	
	<b>\$798.00</b> ⚠
<b>21902</b> .....	<b>56</b>
1956 Chevrolet Convertible Complete Kit -0.15	
	<b>\$666.00</b> ⚠
<b>21903</b> .....	<b>56</b>
1956 Chevrolet Nomad Complete Kit -0.15	
	<b>\$933.00</b> ⚠
<b>21904</b> .....	<b>56</b>
1956 Chevrolet Sedan Complete Kit -0.15	
	<b>\$858.00</b> ⚠
<b>21905</b> .....	<b>56</b>
1956 Chevrolet Sedan Delivery Complete Kit -0.15	
	<b>\$946.00</b> ⚠

Returns require a return authorization number—Please call first. • Note: Product pricing and availability subject to change.

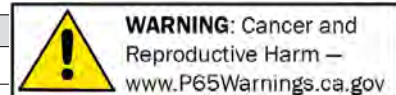

**Acousti-Shield Kits - Chevrolet, cont.**

21906.....	56
1956 Chevrolet Station Wagon Complete Kit -0.15 .....	\$978.00 ⚠
21907.....	57
1957 Chevrolet Coupe Complete Kit -0.15 .....	\$798.00 ⚠
21908.....	57
1957 Chevrolet Nomad Complete Kit -0.15 .....	\$933.00 ⚠
21909.....	57
1957 Chevrolet Sedan Complete Kit -0.15 .....	\$858.00 ⚠
21910.....	57
1957 Chevrolet Sedan Delivery Complete Kit -0.15 .....	\$946.00 ⚠
21911.....	57
1957 Chevrolet Station Wagon Complete Insulation Kit -0.15 .....	\$978.00 ⚠
21912.....	58
1958 Chevrolet Coupe Complete Kit -0.15 .....	\$798.00 ⚠
21913.....	58
1958 Chevrolet Convertible Complete Kit -0.15 .....	\$666.00 ⚠
21914.....	58
1958 Chevrolet Nomad Complete Kit -0.15 .....	\$933.00 ⚠
21915.....	58
1958 Chevrolet Sedan Complete Kit -0.15 .....	\$858.00 ⚠
21916.....	58
1958 Chevrolet Sedan Delivery Complete Kit -0.15 .....	\$974.00 ⚠
21917.....	58
1958 Chev 4-D Station Wagon Complete Kit -0.15 .....	\$978.00 ⚠
21921.....	59
1959 Chevrolet Nomad Station Wagon Complete Kit -0.15 .....	\$947.00 ⚠
21918.....	59-60
1959-1960 Chevrolet Impala Coupe Complete Kit -0.15 .....	\$798.00 ⚠
21919.....	59-60
1959-1960 Chevrolet Convertible Complete Kit -0.15 .....	\$666.00 ⚠
21920.....	59-60
1959-1960 El Camino Complete Kit -0.15 .....	\$570.00 ⚠
21922.....	59-60
1959-1960 Chevrolet Sedan Complete Acoustic Kit -0.15 .....	\$858.00 ⚠
21923.....	59-60
1959-60 Chevrolet Sedan Delivery Complete Kit -0.15 .....	\$974.00 ⚠
21924.....	59-60
1959-60 Chevrolet Station Wagon Complete Kit -0.15 .....	\$1,006.00 ⚠
21925.....	61-62
1961-1962 Chevrolet Coupe Complete Kit -0.15 .....	\$798.00 ⚠

**Acousti-Shield Kits - Chevrolet, cont.**

21926.....	61-62
1961-1962 Chevrolet Convertible Complete Kit -0.15 .....	\$666.00 ⚠
21927.....	63-64
1963-1964 Chevrolet Coupe Complete Kit -0.15 .....	\$798.00 ⚠
21928.....	63-64
1963-1964 Chevrolet Convertible Complete Kit -0.15 .....	\$666.00 ⚠
21929.....	63-64
1963-1964 Chevrolet Sedan Complete Acoustic Kit -0.15 .....	\$858.00 ⚠

**Acousti-Shield Kits - Dodge**

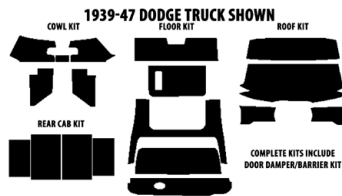

21930.....	39-47
1939-1947 Dodge Truck Complete Kit -0.15 .....	\$559.00 ⚠
21931.....	47-68
1947-1968 Dodge Power Wagon Complete Kit -0.15 .....	\$559.00 ⚠
21932.....	48-53
1948-1953 Dodge Truck Complete Kit -0.15 .....	\$559.00 ⚠
21933.....	54
1954 Dodge Truck Complete Acoustic Kit -0.15 .....	\$559.00 ⚠
21934.....	55-60
1955-1960 Dodge Truck Complete Acoustic Kit -0.15 .....	\$559.00 ⚠

**Acousti-Shield Kits - Ford**



21942.....	37
1937 Ford Panel Delivery Complete Acoustic Kit -0.15 .....	\$1,064.00 ⚠
21943.....	37
1937 Ford Sedan Delivery Complete Acoustic Kit -0.15 .....	\$1,011.00 ⚠
21944.....	37
1937 Ford Truck Complete Kit -0.15 .....	\$559.00 ⚠
21945.....	37-39
1937-39 Ford 3W Coupe Complete Kit -0.15 .....	\$805.00 ⚠
21946.....	37-39
1937-39 Ford 5W Coupe Complete Kit -0.15 .....	\$805.00 ⚠
21947.....	37-39
1937-39 Ford Convertible Complete Kit -0.15 .....	\$668.00 ⚠

**Acousti-Shield Kits - Ford, cont.**

21948.....	37-39
1937-39 Ford Fordor Sedan Complete Kit -0.15 .....	\$871.00 ⚠
21949.....	37-39
1937-39 Ford Tudor Sedan Complete Kit -0.15 .....	\$831.00 ⚠
21950.....	38-39
1938-39 Ford Truck Complete Kit -0.15 .....	\$559.00 ⚠
21951.....	39
1939 Ford Sedan Delivery Complete Acoustic Kit -0.15 .....	\$1,011.00 ⚠
21952.....	39-40
1939-1940 Ford 3 Window Coupe Complete Kit -0.15 .....	\$805.00 ⚠
21953.....	39-40
1939-1940 Ford 5 Window Coupe Complete Kit -0.15 .....	\$805.00 ⚠
21954.....	39-40
1939-40 Ford Convertible Complete Kit -0.15 .....	\$668.00 ⚠
21955.....	39-40
1939-40 Ford Fordor Sedan Complete Kit -0.15 .....	\$871.00 ⚠
21935.....	40
1940 Ford 3W Coupe (Carpenter Body) Complete Acoustic Kit -0.15 .....	\$794.00 ⚠
21956.....	40
1940 Ford Sedan Delivery Complete Kit -0.15 .....	\$1,011.00 ⚠
21957.....	40-47
1940-47 Ford Truck Complete Kit -0.15 .....	\$539.00 ⚠
21958.....	41-48
1941-48 Ford 5W Coupe Complete Kit -0.15 .....	\$805.00 ⚠
21959.....	41-48
1941-48 Ford Convertible Complete Kit -0.15 .....	\$668.00 ⚠
21960.....	41-48
1941-48 Ford Fordor Sedan Complete Kit -0.15 .....	\$871.00 ⚠
21961.....	41-48
1941-48 Ford Sedan Delivery Complete Kit -0.15 .....	\$1,011.00 ⚠
21962.....	41-48
1941-48 Ford Tudor Sedan Complete Kit -0.15 .....	\$831.00 ⚠
21963.....	48-52
1948-1952 Ford Panel Delivery Complete Acoustic Kit -0.15 .....	\$1,066.00 ⚠
21964.....	48-52
1948-52 Ford Truck Complete Kit -0.15 .....	\$539.00 ⚠
21965.....	49-51
1949-51 Ford Coupe Complete Kit -0.15 .....	\$818.00 ⚠
21966.....	49-51
1949-51 Ford Convertible Complete Kit -0.15 .....	\$682.00 ⚠

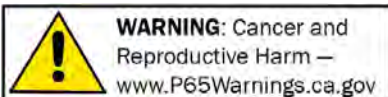

NOTE: Any chemicals will be shipped domestic ground only (Lower 48 states only). No international shipping.

**Acousti-Shield Kits - Ford, cont.**

21967.....	49-51
1949-51 Ford Sedan Complete Kit -0.15	\$879.00 ⚠
21968.....	52-54
1952-54 Ford Coupe Complete Kit -0.15	\$818.00 ⚠
21969.....	52-54
1952-54 Ford Convertible Complete Kit -0.15	\$682.00 ⚠
21970.....	52-54
1952-54 Ford Sedan Complete Kit -0.15	\$879.00 ⚠
21971.....	53-55
1953-55 Ford Panel Delivery Complete Kit -0.15	\$1,064.00 ⚠
21972.....	53-55
1953-55 Ford Truck Small Window Complete Kit -0.15	\$559.00 ⚠
21973.....	55-56
1955-1956 Ford Coupe Complete Kit -0.15	\$818.00 ⚠
21974.....	55-56
1955-1956 Ford Convertible Complete Kit -0.15	\$682.00 ⚠
21975.....	55-56
1955-1956 Ford Sedan Complete Kit -0.15	\$879.00 ⚠
21976.....	55-56
1955-1956 Ford Sedan Delivery Complete Kit -0.15	\$956.00 ⚠
21977.....	55-56
1955-1956 Ford Station Wagon Complete Kit -0.15	\$990.00 ⚠
21978.....	56
1956 Ford Panel Delivery Complete Kit -0.15	\$1,064.00 ⚠
21979.....	56
1956 Ford Truck Large Window Complete Kit -0.15	\$559.00 ⚠
21980.....	56
1956 Ford Truck Small Window Complete Kit -0.15	\$559.00 ⚠
21981.....	57-58
1957-1958 Ford Coupe Complete Kit -0.15	\$818.00 ⚠
21982.....	57-58
1957-1958 Ford Convertible Complete Kit -0.15	\$682.00 ⚠
21983.....	57-58
1957-1958 Ford Ranchero Complete Kit -0.15	\$612.00 ⚠
21984.....	57-58
1957-1958 Ford Sedan Complete Kit -0.15	\$876.00 ⚠
21985.....	57-58
1957-1958 Ford Sedan Delivery Complete Kit -0.15	\$956.00 ⚠
21986.....	57-58
1957-58 Ford Station Wagon Complete Kit -0.15	\$990.00 ⚠

**Acousti-Shield Kits - Ford, cont.**

21987.....	57-60
1957-60 Ford Panel Delivery Complete Kit -0.15	\$1,064.00 ⚠
21988.....	57-60
1957-60 Ford Truck Complete Kit -0.15	\$476.00 ⚠
21989.....	59
1959 Ford Coupe Complete Acoustic Kit -0.15	\$818.00 ⚠
21990.....	59
1959 Ford Convertible Complete Acoustic Kit -0.15	\$682.00 ⚠
21991.....	59
1959 Ford Ranchero Complete Kit -0.15	\$612.00 ⚠
21992.....	59
1959 Ford Sedan Complete Acoustic Kit -0.15	\$879.00 ⚠
21993.....	60-62
1960-1962 Ford Galaxie Starliner Coupe Complete Kit -0.15	\$785.00 ⚠
21994.....	60-62
1960-1962 Ford Galaxie Convertible Complete Kit -0.15	\$648.00 ⚠
21995.....	60-62
1960-1962 Ford Galaxie Sedan Complete Kit -0.15	\$845.00 ⚠
21938.....	60-63
1960-63 Falcon Coupe Complete Kit -0.15	\$805.00 ⚠
21939.....	60-63
1960-63 Falcon Convertible Complete Kit -0.15	\$668.00 ⚠
21940.....	60-63
1960-1963 Falcon Ranchero Complete Kit -0.15	\$584.00 ⚠
21941.....	60-63
1960-1963 Falcon Sedan Complete Kit -0.15	\$824.00 ⚠
21996.....	61-64
1961-1964 Ford Truck Complete Kit -0.15	\$476.00 ⚠
21936.....	62-64
1962-1964 Fairlane/Torino Coupe Complete Kit -0.15	\$811.00 ⚠
21937.....	62-64
1962-1964 Fairlane/Torino Sedan Complete Kit -0.15	\$870.00 ⚠
21997.....	63-64
1963-1964 Ford Coupe Complete Acoustic Kit -0.15	\$785.00 ⚠
21998.....	63-64
1963-1964 Ford Convertible Complete Acoustic Kit -0.15	\$648.00 ⚠
21999.....	63-64
1963-1964 Ford Sedan Complete Acoustic Kit -0.15	\$845.00 ⚠

**Acousti-Shield Kits - Mercury**



22000.....	41-48
1941-1948 Mercury 5W Coupe Complete Acoustic Kit -0.15	\$805.00 ⚠
22001.....	41-48
1941-1948 Mercury Convertible Complete Acoustic Kit -0.15	\$668.00 ⚠
22002.....	41-48
1941-1948 Mercury Fordor Sedan Complete Acoustic Kit -0.15	\$871.00 ⚠
22003.....	41-48
1941-1948 Mercury Tudor Sedan Complete Acoustic Kit -0.15	\$831.00 ⚠
22004.....	49-51
1949-1951 Mercury Coupe Complete Kit -0.15	\$845.00 ⚠
22005.....	49-51
1949-1951 Mercury Sedan Complete Kit -0.15	\$906.00 ⚠
22006.....	52-54
1952-1954 Mercury Coupe Complete Kit -0.15	\$818.00 ⚠
22007.....	52-54
1952-1954 Mercury Convertible Complete Kit -0.15	\$682.00 ⚠
22008.....	52-54
1952-54 Mercury Sedan Complete Kit -0.15	\$879.00 ⚠

**Acousti-Shield Kits - Mopar**

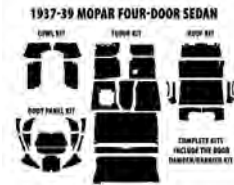

22009.....	37-39
1937-39 Mopar Four-Door Sedan Complete Kit -0.15	\$849.00 ⚠
22010.....	37-39
1937-39 Mopar Two-Door Sedan Complete Kit -0.15	\$762.00 ⚠
22011.....	49-52
1949-52 Mopar Coupe Complete Acoustic Kit -0.15	\$762.00 ⚠
22012.....	49-52
1949-52 Mopar Convertible Complete Acoustic Kit -0.15	\$628.00 ⚠
22013.....	49-52
1949-52 Mopar Sedan Complete Kit -0.15	\$808.00 ⚠

Returns require a return authorization number—Please call first. • Note: Product pricing and availability subject to change.

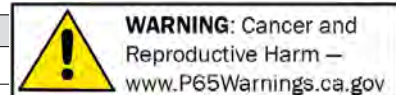

**Acousti-Shield Kits - Mopar, cont.**

22014.....	53-54
1953-54 Mopar Coupe Complete Kit -0.15	\$762.00 ⚠
22015.....	53-54
1953-54 Mopar Convertible Complete Kit -0.15	\$628.00 ⚠
22016.....	53-54
1953-54 Mopar Sedan Complete Kit -0.15	\$808.00 ⚠
22017.....	55-56
1955-56 Mopar Coupe Complete Kit -0.15	\$762.00 ⚠
22018.....	55-56
1955-56 Mopar Convertible Complete Kit -0.15	\$628.00 ⚠
22019.....	55-56
1955-56 Mopar Sedan Complete Kit -0.15	\$808.00 ⚠

**Acousti-Shield Kits - Oldsmobile**

22020.....	54-56
1955-56 Oldsmobile 88 Coupe Complete Kit -0.15	\$801.00 ⚠
22021.....	54-56
1955-56 Oldsmobile 88 Convertible Complete Kit -0.15	\$668.00 ⚠
22022.....	54-56
1955-56 Oldsmobile 88 Sedan Complete Kit -0.15	\$860.00 ⚠
22023.....	57-58
1957 Oldsmobile 88 Coupe Complete Kit -0.15	\$773.00 ⚠
22024.....	57-58
1957 Oldsmobile 88 Convertible Complete Kit -0.15	\$644.00 ⚠
22025.....	57-58
1957 Oldsmobile 88 Sedan Complete Kit -0.15	\$830.00 ⚠

**Ultimate Noise Barrier Kit**

Ultimate Noise Barrier Kit includes: One vibration damping sheet (VB-2) Four acoustic sound floor barrier sheets (VBLOK-VB4.5) One gallon of sprayable sound deadener (DEADENER) Complete instructions for all items in kit.

- The vibration damping sheet comes with adhesive backing, molds to inner door frame with the use of a heat gun, is 40% lighter than asphalt damping materials & can handle continuous temperatures to 250 degrees. (covers 14 square feet).

- The acoustic sound floor barrier sheet is a high performance composite consisting of a flexible loaded vinyl massing barrier with a form decoupling layer designed to reduce road noise coming into the vehicle. it is ideal for applications over flooring, side panels & firewall. (covers 14 sq. ft. each sheet)

- The sprayable sound deadener is a high performance air curing, damping compound designed specifically for the interior & exterior side of body panels. Easy to apply non-toxic water based. (covers 30 sq. ft.)

13209.....	ALL
Ultimate noise barrier kit. 8.800 -0.15	\$500.00 KIT ⚠

**Basic Noise Barrier Kit**

Basic Noise Barrier Kit includes: Two thermal acoustic blankets (VBLOK-INS12) One gallon of sprayable sound deadener (DEADENER) Σ Spray-on adhesive material & specialty seam tape Complete instructions for all items in kit.

Sprayable sound deadener is a high performance air curing damping compound designed specifically for the interior & exterior side of body panels. Easy to apply, non-toxic, water based (VB-1X). 30 sq. ft. of coverage.

Thermal acoustic blankets designed with foil (top and bottom) to reflect heat with a cotton fiber layer to insulate & absorb moderate sound levels (VBLOK-INS12).

The spray on adhesive material is used to attach the insulator to the applied surface (GC-1).

The specialty seam tape is used to join multiple insulators together (ST-1).

13211.....	ALL
Basic noise barrier kit 8.800 -0.2	\$300.00 KIT ⚠

**Individual Heatshield & Noise Barrier Components**



8.800 -0.15

**DEADENER . . . ALL**  
Engineered for the interior & exterior side of body panels. 200% decrease in noise & vibration. Bonds to metal, fiberglass & wood. Covers 30 sq. ft.



**\$85.00 GALLON ⚠**  
**SPRAYGUN. . . ALL**  
Spray gun. Siphon-feed spray gun for DEADENER. 8.800 -0.15

..... \$89.25 EA ⚠



**VB-1SPRO . . . ALL**  
For exterior automotive panels such as inside fender wells, wheel arches and underside of the floor pan. Converts structural resonance and vibration into

low level heat through friction. It remains soft which allows it to absorb the impact of road debris. (NOTE: Only apply to exterior surfaces due to prolonged outgassing). 18 oz. aerosol can. Covers 4 sq. ft. 8.800 -0.15

..... \$14.50 EA ⚠

**VB-2 . . . ALL**  
Individual sheet. Thickness= .042". 8.800 -0.15

..... \$61.00 EA ⚠

**VB-2HD. . . ALL**  
HEAVY DUTY individual sheets. Thickness= .075" 8.800 -0.15

..... \$95.25 EA ⚠



**VBLOK-INS12 . . . ALL**  
Guards against heat, sound, vibration & airflow. All natural fiber layer & foil exterior. Provides 50% greater R value than other reflective insulation materials. 8.800 -0.15

..... \$85.00 EA ⚠



NOTE: Any chemicals will be shipped domestic ground only (Lower 48 states only). No international shipping.

**Individual Heatshield & Noise Barrier Components, cont.**



**VBLOK-VB4** .....ALL

Flexible Road Noise Barrier.  
14 square feet.

Composite product that has been engineered to block and reflect high energy, low frequency road noise across a wide frequency range. Consists of a closed cell neoprene foam layer that is bonded to a dense 1lb per sq ft vinyl barrier.

8.800 -0.15 ..... **\$89.00 EA** ⚠

**Vibration Dampening**



**V-MAXBP** .....ALL

CLD Vibration Damping Material.

52 square feet, 20 piece kit. 8.800 -0.15

..... **\$245.00 EA** ⚠



**V-MAXMP** .....ALL

Vibration Damping Material.

2.8 square feet, 4 piece kit. 8.800 -0.15

..... **\$30.50 EA** ⚠

**V-MAXSP** ..... ALL

CLD Vibration Damping Material.

26 square feet, 10 piece kit. 8.800 -0.15

..... **\$128.00 EA** ⚠

**Body Deadener**



**121126C** .....ALL

Hi-tech, 1/2 pound per square foot (3/16 in. x 3 ft x 8 ft). 15.492 -0.15

..... **\$40.25 EA** ⚠

**Jute Insulation**

**3693008A** ..... ALL

Jute w/ foil on 1 side (4 ft wide).

16.802 -0.15 ..... **\$9.49 FT** ⚠

**Jute Insulation, cont.**

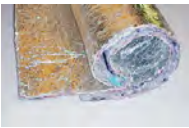

**3693008B** .....ALL

Jute w/ foil on 2 sides (4 ft wide). 16.802 -0.15

..... **\$12.69 FT** ⚠



**3693008C** .....ALL

Foil tape for jute insulation (30 foot x 2 in. roll). 16.802 -0.15

..... **\$11.99 EA** ⚠

**Aluminum Trim Plates -Split & Pinned**



**WASB01S** .....ALL

Split & pinned, Round. Aluminum, small, round hole to finish brake and clutch pedal shafts and around dimmer switch. Also great for around wires, hoses, harnesses or anything you want to trim. 2-1/4" dia. w/ 15/16" dia. hole, stainless screws and rubber gasket. -0.15 ..... **\$21.00 EA** ⚠

**WASB01ST** .....ALL

Split & pinned, Round. For use with wires, bundles, harnesses, cables, etc. Has an insulated rubber grommet with 5/8" I.D. Overall size is 2-1/4" O.D. with stainless steel screws. -0.15 ..... **\$25.00 EA** ⚠



**WASB020VS** .....ALL

Split & pinned, Oval. Aluminum. Great new Oval shaped body. For elongated or rectangular pedal shafts Also trim the firewall for accelerator cable and kick down or for some TPI applications. 1-5/8" X 2-1/4" wide. 5/8" x 1-1/8" hole. Stainless steel screws & rubber gasket. -0.15 ..... **\$26.00 EA** ⚠

**Aluminum Trim Plates -Split & Pinned, cont.**



**WASB02S** .....ALL

Split & pinned, Round. Aluminum, small, oval hole to finish brake and clutch pedal shafts and around dimmer switch. Also great for around wires, hoses, harnesses or anything you want to trim. 2-1/4" dia. w/ 15/16" dia. hole, stainless screws and rubber gasket. -0.15 ..... **\$21.75 EA** ⚠

**Aluminum Trim Plates -Solid**

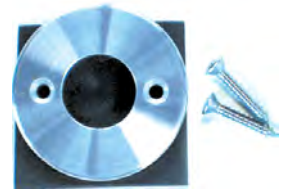

**WASB01** .....ALL

Solid, Round. Aluminum, small, round hole to finish brake and clutch pedal shafts and around dimmer switch. Also great for around wires, hoses, harnesses or anything you want to trim. 2-1/4" dia. w/ 15/16" dia. hole, stainless screws and rubber gasket. -0.15 ..... **\$17.00 EA** ⚠



**WASB02** .....ALL

Solid, Round. Aluminum, small, oval hole to finish brake and clutch pedal shafts and around dimmer switch. Also great for around wires, hoses, harnesses or anything you want to trim. 2-1/4" dia. w/ 15/16" dia. hole, stainless screws and rubber gasket. -0.15 ..... **\$17.00 EA** ⚠

**WASB05** .....ALL

Solid, Round. For use with wires, bundles, harnesses, cables, etc. Has an insulated rubber grommet with 5/8" I.D. Overall size is 2-1/4" O.D. with stainless steel screws. -0.15 ..... **\$16.00 EA** ⚠

**Gas Pedals**



**BAG-6004 . . . .ALL**  
Billet aluminum gas pedal pad w/ rubber insert. 3.451 -0.15  
..... **\$156.00 EA** ⚠



**BAG-6004X . . . .ALL**  
Midnight Series. Billet aluminum gas pedal pad w/ rubber insert. Black anodized. 3.451 -0.15  
..... **\$156.00 EA** ⚠



**BAG-6151 . . . .ALL**  
Chrome finish. -0.15  
..... **\$93.89 EA** ⚠



**BAG-6151X . . . .ALL**  
Black (Midnight Series). -0.15  
..... **\$96.75 EA** ⚠



**BAG-6154 . . . .ALL**  
Raw finish. -0.15  
..... **\$91.00 EA** ⚠



**BFG-6012 . . . .ALL**  
Extra-large billet aluminum gas pedal pad w/ rubber insert. 3.451 -0.15  
..... **\$164.50 EA** ⚠

**Gas Pedals, cont.**



**BFG-6012X . . . .ALL**  
Midnight Series. Extra-large billet aluminum gas pedal pad w/ rubber insert. Black anodized. 3.451 -0.15  
..... **\$164.50 EA** ⚠



**BIS199110 . . . .ALL**  
Gas Pedal, Rectangular polished. -0.15  
..... **\$112.00 EA** ⚠



**BIS199115 . . . . .ALL**  
Gas Pedal, Rectangular black anodized. -0.15  
..... **\$112.00 EA** ⚠



**BIS199130 . . . . .ALL**  
Gas Pedal, Oval polished. -0.15  
..... **\$112.00 EA** ⚠



**BIS199135 . . . . .ALL**  
Gas Pedal, Oval black anodized. -0.15  
..... **\$112.00 EA** ⚠



**BIS199137 . . . .ALL**  
Oval Black Anodized. Carbon Fiber Inset. -0.15  
..... **\$160.00 EA** ⚠

**BIS199172 . . . .ALL**  
Rectangle Polished Carbon Fiber Inset. -0.15  
..... **\$175.00 EA** ⚠



**BIS199177 . . . .ALL**  
Oval Black Anodized. Carbon Fiber Inset. -0.15  
..... **\$175.00 EA** ⚠

**Gas Pedals, cont.**



**CMW-TA204 . . . .ALL**  
Chrome Gas Pedal -0.15  
..... **\$153.00 EA** ⚠



**FMG-6098 . . . .ALL**  
Billet aluminum, floor mounted gas pedal w/ rubber insert. 3.451 -0.15  
..... **\$174.00 EA** ⚠



**FMG-6098X . . . .ALL**  
Midnight Series. Billet aluminum, floor mounted gas pedal w/ rubber insert. 3.451 -0.15  
..... **\$174.00 EA** ⚠



**R8503 . . . . .ALL**  
Polished Aluminum Gas Pedal with 2 Rubber Inserts - Floor Mount. -0.15  
..... **\$90.50 EA** ⚠



**R8504 . . . . .ALL**  
Chrome Aluminum Gas Pedal with 2 Rubber Inserts - Floor Mount. -0.15  
..... **\$106.75 EA** ⚠



**R8520 . . . . .ALL**  
Barefoot Gas Pedal. -0.15  
..... **\$13.29 EA** ⚠

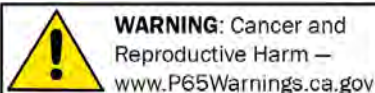

NOTE: Any chemicals will be shipped domestic ground only (Lower 48 states only). No international shipping.



**Gas Pedals, cont.**



**R8600POL** . . . . .ALL  
 Chrome Steel Arm &  
 Polished Aluminum  
 Gas Pedal Pad  
 with Six Rubber  
 Inserts. -0.15  
 . . . . . \$49.79 EA ⚠



**R8601POL** . . . . .ALL  
 Chrome Steel Arm &  
 Polished Aluminum  
 Gas Pedal Pad  
 with Two Rubber  
 Inserts. -0.15  
 . . . . . \$50.00 EA ⚠



**R8601X** . . . . .ALL  
 Polished Aluminum Gas Pedal Pad with  
 Two Rubber Inserts. -0.15  
 . . . . . \$64.59 EA ⚠



**R9507** . . . . .ALL  
 Chrome Firewall  
 Mount Gas  
 Pedal. -0.15  
 . . . . . \$35.25 EA ⚠



**R9507X** . . . . .ALL  
 Polished Aluminum  
 Firewall Mount Gas  
 Pedal. -0.15  
 . . . . . \$54.25 EA ⚠



**SG-6007** . . . . .ALL  
 Chromed steel gas  
 pedal pad w/ rubber  
 insert. 3.451 -0.15  
 . . . . . \$120.00 EA ⚠

**Gas Pedals, cont.**



**SG-6016** . . . . .ALL  
 Extra-large chrome  
 steel gas pedal pad w/  
 rubber insert. 3.451 -0.15  
 . . . . . \$125.79 EA ⚠



satin/brushed finish shown

**SMP22030P** . . . . .ALL  
 Polished finish. 3.451 -0.15  
 . . . . . \$100.00 EA ⚠

**Brake & Clutch Pedal Pads**



**BAG-6005** . . . . .ALL  
 Billet aluminum brake  
 pedal pad w/ rubber  
 insert. 3.451 -0.15  
 . . . . . \$54.25 EA ⚠



**BAG-6005X** . . . . .ALL  
 Midnight Series. Billet  
 aluminum brake pedal  
 pad w/ rubber insert.  
 Black anodized. 3.451 -0.15  
 . . . . . \$52.59 EA ⚠



**BAG-6152** . . . . .ALL  
 Chrome finish for  
 brake/clutch -0.15  
 . . . . . \$59.00 EA ⚠



**BAG-6152X** . . . . .ALL  
 Black (Midnight  
 Series). For brake/  
 clutch -0.15  
 . . . . . \$59.00 EA ⚠



**BAG-6153** . . . . .ALL  
 Chrome finish. Brake for automatic  
 transmission. -0.15 . . . . . \$66.00 EA ⚠

**Brake & Clutch Pedal Pads, cont.**



**BAG-6153X** . . . . .ALL  
 Black (Midnight Series) for automatic  
 transmission. -0.15 . . . . . \$66.00 EA ⚠



**BAG-6155** . . . . .ALL  
 Raw finish. Brake or  
 clutch -0.15  
 . . . . . \$59.00 EA ⚠



**BAG-6156** . . . . .ALL  
 Raw finish. Brake for automatic  
 transmission -0.15 . . . . . \$66.00 EA ⚠



**BFG-6013** . . . . .ALL  
 Extra-large billet aluminum brake pedal  
 pad w/ rubber insert.  
 3-5/8" x 2-3/4". 4.630 -0.15  
 . . . . . \$53.25 EA ⚠



**BFG-6013X** . . . . .ALL  
 Midnight Series. Extra-  
 large billet aluminum  
 brake pedal pad w/  
 rubber insert. Black anodized. 4.630 -0.15  
 . . . . . \$53.25 EA ⚠



**BIS199310** . . . . .ALL  
 Brake Pedal, Rectangular polished. -0.15  
 . . . . . \$35.50 EA ⚠

**Brake & Clutch Pedal Pads, cont.**



**BIS199315**.....ALL  
Brake Pedal,  
Rectangular black  
anodized. -0.15  
..... **\$35.25 EA** ⚠



**BIS199330**.....ALL  
Brake Pedal, Oval  
polished. -0.15  
..... **\$35.50 EA** ⚠



**BIS199335**.....ALL  
Brake Pedal, Oval black  
anodized. -0.15  
..... **\$35.75 EA** ⚠



**BIS199372**.....ALL  
Universal Style Brake/Clutch Polished with  
Carbon Fiber insert. -0.15  
..... **\$95.00 EA** ⚠



**BIS199377**.....ALL  
Universal Style Brake/Clutch Black  
Anodized with Carbon Fiber insert. -0.15  
..... **\$95.00 EA** ⚠



**BIS199472**.....ALL  
Universal Style Polished Brake Pedal with  
Carbon Fiber insert. -0.15  
..... **\$120.00 EA** ⚠



**BIS199477**.....ALL  
Universal Style Black Anodized Brake  
Pedal with Carbon Fiber insert. -0.15  
..... **\$120.00 EA** ⚠

**Brake & Clutch Pedal Pads, cont.**



**BIS199672**.....ALL  
Universal Style E-Brake Polished with  
Carbon Fiber insert. -0.15  
..... **\$35.00 EA** ⚠



**BIS199677**.....ALL  
Universal Style E-Brake Black Anodized  
with Carbon Fiber insert. -0  
..... **\$30.00 EA** ⚠



**CMW-BP302**.....ALL  
Chrome brake/clutch  
pad. -0.15  
..... **\$42.00 EA** ⚠



**CMW-BP304**.....ALL  
Chrome brake/clutch  
pedal -0.15  
..... **\$42.00 EA** ⚠



**R8500POL**.....ALL  
Polished Aluminum  
Brake Pad with Three  
Rubber Inserts. Comes  
with mounting stud and bolt. -0.15  
..... **\$28.69 EA** ⚠



**R8501POL**.....ALL  
Polished Aluminum  
Brake Pad with Two  
Rubber Inserts. Comes  
with mounting stud and bolt. -0.15  
..... **\$24.00 EA** ⚠



**R8502**.....ALL  
Chrome Steel Round  
Brake Pad with Rubber  
Insert. -0.15  
..... **\$15.99 EA** ⚠



**SG-6008**.....ALL  
Chromed steel w/  
rubber insert.  
3-3/16" x 1-7/8".  
4.630 -0.15  
..... **\$51.00 EA** ⚠



**SG-6017**.....ALL  
Extra-large chromed  
steel brake pedal  
pad w/ rubber insert.  
4.630 -0.15  
..... **\$61.50 EA** ⚠

**Brake & Clutch Pedal Pads, cont.**



**SMP22031P**.....ALL  
Polished finish.  
3.451 -0.15  
..... **\$33.00 EA** ⚠



**SMP22031S**.....ALL  
Satin finish. 3.451 -0.15  
..... **\$20.00 EA** ⚠

**Dimmer Switch Pads**



**BIS199860**...ALL  
Dimmer switch cover  
Polished. -0.15  
..... **\$17.00 EA** ⚠



**BIS199865**...ALL  
Dimmer switch  
cover Black  
Anodized. -0.15  
..... **\$15.75 EA** ⚠



**BIS199870**...ALL  
Dimmer Switch Cap  
Polished. -0.15  
..... **\$15.75 EA** ⚠

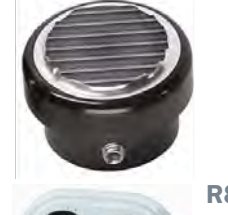

**BIS199875**...ALL  
Dimmer Switch Cap  
Black anodized. -0.15  
..... **\$17.00 EA** ⚠



**R8514**.....ALL  
Polished Aluminum with  
Rubber Insert. -0.15  
..... **\$11.75 EA** ⚠

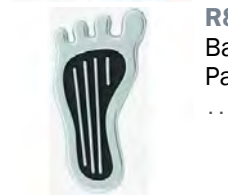

**R8521**.....ALL  
Barefoot Dimmer  
Pad. -0.15  
..... **\$4.99 EA** ⚠

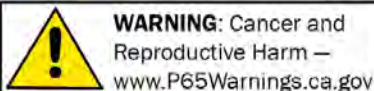

NOTE: Any chemicals will be shipped domestic ground only (Lower 48 states only). No international shipping.

**Section 330: Interior, Sunvisors, Dome Lights, Headliners, Door Panels, Kick Panels, Seats, Seat Covers & Belts**

**Sunvisor Exterior Chevy**



**986877**.....**37-48**  
Car. Exterior windshield visor. Sheetmetal, fabricated. 10.201-0.15 . **\$316.25 EA** ⚠



**986877FS** .....**37-48**  
Car exterior visor. Metal. Repro of Fulton w/ mounting hardware & instructions. Adjustable. Fits 30s-50s Chevy, Ford. Dodge and Plymouth 10.201-0.15  
..... **\$495.00 EA** ⚠



**986877FS** .....**47-53**  
Truck exterior visor. Metal, Fulton reproduction with mounting hardware & instructions. Adjustable. 10.201-0.15  
..... **\$495.00 EA** ⚠



**986433**.....**49-52**  
Car, steel with mounting hardware & instructions. Fleetline/ Styleline. 10.201-0.15 ..... **\$495.00 EA** ⚠



**9864331P** .....**49-52**  
Steel with mounting hardware & instructions. Fleetline/ Styleline exc Hardtop & convertible cars. Made for one piece curved windshields. 10.201-0.15  
..... **\$574.00 EA** ⚠

**Sunvisor Exterior Chevy, cont.**



**986433H** .....**50-52**  
Bel Air Hardtops. Steel with mounting hardware & instructions. 10.201-0.15  
..... **\$576.00 EA** ⚠



**986674**.....**53-54**  
Car, steel with mounting hardware & instructions. 10.201-0.15 ..... **\$497.75 EA** ⚠



**986675**.....**53-54**  
Steel with mounting hardware & instructions. Non-adjustable. Fits 53-54 Hardtop. 10.201-0.15 ... **\$573.75 EA** ⚠



**986878S** .....**54-55**  
Steel reproduction with mounting hardware & instructions. Fits Chevy & GMC trucks. 10.201-0.15 ..... **\$450.00 EA** ⚠

**Sunvisor Components Chevy**



**986877CS** .....**37-54**  
Exterior center windshield visor support replacement brackets. 10.201-0.15  
..... **\$29.00 SET** ⚠

**Sunvisor Components Chevy, cont.**



**3699965** .....**53-54**  
Center mounting bracket for exterior sunvisor. 10.201-0.15 ..... **\$52.00 EA** ⚠



**986674A**.....**53-54**  
Side brackets steel with mounting hardware & instructions. For reproduction visors, not original. 10.201-0.15  
..... **\$97.75 PR** ⚠

**Traffic Light Viewer**



**986550**.....**50-56**  
Superb reproduction. 10.201-0.15  
..... **\$45.25 EA** ⚠



**986550G** .....**50-56**  
"GUIDE". 10.201-0.15  
..... **\$22.50 EA** ⚠



**986550MB**.....**ALL**  
"GUIDE" magnetic base mount. 10.201-0  
..... **CALL** ⚠

**Header Panel Chevy Truck**



**593369**.....**36-38**  
Mounts above windshield (fiberglass). 16.562-0.15 ..... **\$129.00 EA** ⚠  
**598772**.....**39-46**  
Mounts above windshield (fiberglass). 16.563-0.15 ..... **\$129.00 EA** ⚠

# Section 330: Interior, Sunvisors, Dome Lights, Headliners, Door Panels, Kick Panels, Seats, Seat Covers & Belts

## Headliner Conversion

**3808406C46** .....41-46  
Panel or Suburban napped cotton hardware kit for installation is included.  
16.742 -0.15

..... **\$299.00 EA** ⚠

**3808406C54** .....47-54  
Panel or Suburban napped cotton hardware kit for installation is included.  
16.742 -0.15

..... **\$299.00 EA** ⚠

## Headliners -Moulded ABS Plastic

ABS Plastic with a medium embossed leather grain texture. This material is easily formed with heat and duplicates the original look and texture exactly. ABS plastic is very tough, yet flexible, and does not show scratches or scuffs. Can be easily dyed with a flat vinyl plastic spray paint.

All patterns are based on out-of-vehicle originals. The panels also can be covered with cloth or acoustic material.

Note: Oversize shipping charges apply on headliners. Please call for rates.



**593125P** .....37-38  
Fits Chevy trucks (exc. Suburban).

16.742 -0.15 ..... **\$246.50 EA** ⚠

**3654634P** .....39-46  
Fits Chevy trucks (exc. Panel & Suburban). 16.742 -0.15

..... **\$246.50 EA** ⚠

**3676356P** .....47-53  
Fits Chevy trucks (exc. Suburban).

16.742 -0.15 ..... **\$246.50 EA** ⚠

**3676357P** .....47-53  
Fits Chevy trucks (exc. Suburban).

16.742 -0.15 ..... **\$150.25 EA** ⚠

**3700527P** .....54  
Fits Chevy trucks (exc. Suburban).

16.742 -0.15 ..... **\$150.25 EA** ⚠

## Headliner (ABS)

Note: Oversize shipping charges apply on headliners. Please call for rates.

**RD-3085** .....47-48  
Smooth ABS Headliner for Chevy Trucks -0.15

..... **\$249.50 EA** ⚠

**RD-3086** .....49-53  
Smooth ABS Headliner for Chevy trucks. -0.15

..... **\$249.50 EA** ⚠

## Headliner (ABS), cont.



**RD-3089** .....49-53  
Quinn design headliner for Chevy trucks -0.15

..... **\$299.50 EA** ⚠

**RD-3087** .....54-55  
Smooth ABS Headliner design for round rear window cabs. -0.15

..... **\$249.25 EA** ⚠

## RodDoors Interior Panels Chevy Trucks

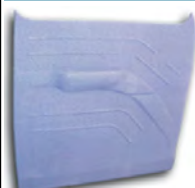

**RD-3080** .....47-55  
Eureka door panels, contoured to match truck door. -0.15

..... **\$259.50 PR** ⚠



**RD-3083** .....47-55  
Quinn styled ABS plastic. Ready to paint or cover. -0.15

..... **\$109.00 PR** ⚠



**RD-3092** .....47-55  
Eureka rear cab cover for Chevy trucks with tank in cab. -0.15

..... **\$275.00 EA** ⚠



**RD-3240** .....47-55  
Quinn with armrests & art deco inserts. -0.15

..... **\$299.50 PR** ⚠



**RD-3241** .....47-55  
Quinn with armrests, NO art deco inserts. -0.15

..... **\$269.50 PR** ⚠



**RD-3242** .....47-55  
Quinn no armrest, no art deco inserts. -0.15

..... **\$249.50 PR** ⚠

**RD-3091** .....49-55  
Eureka rear cab cover for Chevy trucks without tank in cab. -0.15

..... **\$275.50 EA** ⚠

## Door Panels Bead Rolled Aluminum - Chevy Truck

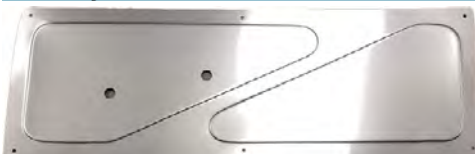

**4754DP** .....47-54

Aluminum Door Panels are a replacement part for the original cardboard door panels. Made from 20 gauge aluminum these door panels mount with screws in the factory location. -0

..... **\$150.00 L&R** ⚠

## Kick Panels Bead Rolled Steel - Chevy Truck



**4754KP** .....47-54

Kick Panels are made to install as a cover or can be used as a replacement part. The kick panels are laser cut from 18 gauge steel and can be fastened with screws, Velcro, welding or however the installer sees fit. -0

..... **\$140.00 L&R** ⚠

## ABS Panel Board

### ABS Panel Board



**DPNLBRD** .....ALL

Panel size is: 1/8 inch thick x 32 inches tall x 49 inches wide. -0

..... **CALL** ⚠

## Door Panel Fasteners



**DPNLFASTNR** .....ALL

Nylon type which will work for most vehicles. 1/8" diam. x 1- 15/32" length. Box of 25 pcs. -0.15

..... **\$17.49 SET** ⚠

## MAG DADDY - Universal Magnetic Clips



**MDU-DOORTRIM** .....ALL

Mag Daddy Universal Door Panel / Trim Kit 8.950 -0.15

..... **\$79.99 SET** ⚠



**MDU-GD** .....ALL

Mag Daddy Universal glue style magnet - 3 pack Great for door panels or trim pieces. 8.950 -0.15

..... **\$13.59 SET** ⚠



**WARNING: Cancer and Reproductive Harm** —  
www.P65Warnings.ca.gov

NOTE: Any chemicals will be shipped domestic ground only (Lower 48 states only). No international shipping.

(800) 952-1752 • www.streetrodhq.com

**MAG DADDY - Universal Magnetic Clips, cont.**



**MDU-GGD . . . . .ALL**  
Mag Daddy Universal grand glue style magnet - 2 pack Great for door panels or trim pieces. 8.950 -0.15



**\$14.00 SET** ⚠️  
**MDU-RESTOKIT . . .ALL**  
Mag Daddy Universal Restoration Kit 8.950 -0.15



**\$85.19 SET** ⚠️  
**MDU-STARTERKIT .ALL**  
Mag Daddy Universal Starter Kit 8.950 -0.15

**\$77.29 SET** ⚠️

**Custom Door Arm Rest**

Hand laid fiberglass arm rests. Comfortable ergonomic design with built in handle pull. Ready for sand and paint or cover with interior material. Mounting hardware included.



**ARM3050 . . . . .ALL**  
Roadster style. -0.15



**\$170.00 L&R** ⚠️  
**ARM3051 . . . . .ALL**  
Hot Rod style. -0.15



**\$122.00 L&R** ⚠️  
**ARM3052 . . . . .ALL**  
Shorty style. -0.15



**\$122.00 L&R** ⚠️  
**ARM3053 . . . . .ALL**  
Coupe style. -0.15

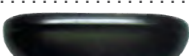

**\$129.00L&R** ⚠️  
**ARM3054 . . . . .ALL**  
Classic style. -0.15



**\$122.00L&R** ⚠️  
**ARM3055 . . . . .ALL**  
Tri 5 style. -0.15



**\$129.00 L&R** ⚠️  
**ARM3056 . . . . .ALL**  
Slick style. -0.15



**\$130.00 L&R** ⚠️  
**ARM3057 . . . . .ALL**  
Slick style. (Requires handle part number SMP22002) -0.15



**\$160.00 L&R** ⚠️  
**ARM3058 . . . . .ALL**  
Grabber style. -0.15



**\$180.00 L&R** ⚠️  
**ARM3059 . . . . .ALL**  
Boattail style. -0.15



**\$129.00 L&R** ⚠️  
**ARM3060 . . . . .ALL**  
Sixty's style. -0.15



**\$129.00 L&R** ⚠️  
**ARM3065 . . . . .ALL**  
Tri 5 mini style. -0.15



**\$122.00 L&R** ⚠️

**Custom Door Arm Rest, cont.**



**SMP23070 . . . . .ALL**  
Fiberglass speaker pod/map pocket. -0.15

**\$168.00 L&R** ⚠️

**Door Pull Kit (ABS)**



**RD-1010 . . . . .ALL**  
Small (4" x 1.25" x .56" deep). ABS plastic. -0.15

**\$39.00 SET** ⚠️

**Cup Holders**



**4754CH2 . . . . .47-54**  
This cup holder is a direct bolt in for your classic Chevy pickup. No drilling required. Laser cut from 16 gauge stainless steel with aluminum cups -0

**\$50.00 EA** ⚠️



**4754CH3 . . . . .47-54**  
This cup holder is a direct bolt in for your classic Chevy pickup. No drilling required. Laser cut from 16 gauge stainless steel with aluminum cups-0

**\$55.00 EA** ⚠️



**6066CH2 . . . . .60-66**  
This cup holder is a direct bolt in for your classic Chevy pickup. No drilling required. Laser cut from 16 gauge stainless steel with aluminum cups -0

**\$50.00 EA** ⚠️



**6066CH3 . . . . .60-66**  
This cup holder is a direct bolt in for your classic Chevy pickup. No drilling required. Laser cut from 16 gauge stainless steel with aluminum cups-0

**\$55.00 EA** ⚠️



**CUPHOLDO . . . . .ALL**  
Polished, oval billet aluminum face. Sliding, hidden single cup. 6 5-8in. wide x 3-4in. high x 6in. deep. 10.185 -0.15

**\$148.69 EA** ⚠️



**CUPHOLDS . . . . .ALL**  
Polished, oval billet aluminum face. Sliding, hidden single cup. 6 5-8in. wide x 3-4in. high x 6in. deep. 10.185 -0.15

**\$148.75 EA** ⚠️



**WASB-DH . . . . .ALL**  
Magnetic base allows you to use when needed, hide when not. 3" I.D., 2-1/2" deep. Includes plastic inner cup to hold condensation. Dual black o-rings for added grip and looks. -0.15

**\$39.00 EA** ⚠️

**Seat Risers**



**SR2 . . . . .ALL**  
2" to 2-1/2" height. 14.998 -0.15

**\$75.00 SET** ⚠️

**SR4 . . . . .ALL**  
2-1/2" to 3-3/4" height. 14.998 -0.15

**\$75.00 SET** ⚠️

**SRT4 . . . . .ALL**  
4" to 6-1/2" height. 14.998 -0.15

**\$139.00 SET** ⚠️

**TB5 . . . . .ALL**

This seat riser tunnel bracket adds an additional flat surface to mount seat risers that would be tight against the tunnel. Mounts to the side of the transmission tunnel and can be bent to fit. 14.998 -0

**CALL** ⚠️

**Seat Slider Tracks**



**ST12 . . . . .ALL**  
12" travel for back seat access. 14.998 -0

**CALL** ⚠️



**ST7 . . . . .ALL**  
7" travel for bucket seat. 14.998 -0

**CALL** ⚠️

**Seat Warmers**



**WARMSEAT . . . . .ALL**  
Do it yourself seat warmers. Seat back and bottom. Hi-Low-Off switch for each seat. 12V, 3.5 amp. Includes instructions. -0.15

**\$100.00 EA** ⚠️

# Section 330: Interior, Sunvisors, Dome Lights, Headliners, Door Panels, Kick Panels, Seats, Seat Covers & Belts

## Seat Belts

2-point Aircraft style seat belts w/ chrome buckle. Length 74 inches.



**1001** .....ALL  
Lap belts available in black, burgundy, Grey or tan (specify color when ordering). Comes with standard pushbutton release. 52" 14.875 -0.15 ..... **\$21.00 EA** ⚠️



**2002** .....ALL  
2-point retractable lap only belts available in black, burgundy, Grey or tan (specify color when ordering). Comes with standard pushbutton release. 14.875 -0.15 ..... **\$60.00 EA** ⚠️



**SBELTA** .....ALL  
Aircraft style, chrome buckle lap belt. Choose color: Black, Dark Blue, Brown, Grey, Maroon, Red Wine, Red or Tan (hardware kit sold separately). 74" 14.875 -0 ..... **\$22.00 EA** ⚠️



**SBELTGM** .....ALL  
GM push button, chrome/silver buckle lap belt. Choose color: Black, Blue, Grey, or Red (hardware kit sold separately). 74" 14.875 -0 ..... **starting at \$29.00 EA** ⚠️

## Seat Belt Anchor Kit

**13245** .....ALL  
Hardware anchor kit for one complete seat belt. Includes 2 of each: bolts, washers, lock washers and nuts. 14.875 -0.2 ..... **\$4.00 SET** ⚠️



## Seat Belt Anchor Kit, cont.

**SBHP** .....ALL  
Deluxe reinforcing anchor plates. Reduces chance of floor damage on high belt loads. Kit for 1 belt. 14.875 -0.15 ..... **\$15.00 SET** ⚠️

**SBHPA** .....ALL  
Angled anchor mounts for flat floor applications. Use with part #SBHP to complete your seat belt installation. Kit for 1 belt. 14.875 -0.15 ..... **\$15.50 SET** ⚠️

## Hog Rings

**HOGRING** .....ALL  
Upholstery hog rings, set of 100 pieces. -0.4 ..... **\$7.50 SET** ⚠️

**HOGTOOL** .....ALL  
Hog ring upholstery pliers to install seat upholstery. 14.880 -0.15 ..... **\$17.25 EA** ⚠️

## Dome Lights

**CMW-DM402** .....ALL  
Add the finishing touch to your interior with this beautifully designed Chrome plated dome light with frosted lens. (Paul Atkins Signature Series) 4-1/2" x 2" x 7/8". Mounting Depth 1/2". -0.15 ..... **\$60.25 EA** ⚠️

**HR5004** .....ALL  
Stepped, polished bezel with white glass lens. 4-3/4" dia. -0.15 ..... **\$75.09 EA** ⚠️

**HR5005** .....ALL  
Smooth, polished bezel with white glass lens. 4-3/4" dia. No on/off. -0.15 ..... **CALL** ⚠️

**SMP22052B** .....ALL  
Plastic. Black finish, single lens. Pushbutton on/ off. 4-1/2" X 3-1/2" -0.15 ..... **\$27.00 EA** ⚠️

**SMP22052P** .....ALL  
Polished finish, single lens. Pushbutton on/ off. 4-1/2" X 3-1/2" -0 ..... **\$89.25 EA** ⚠️

**SMP22052S** .....ALL  
Satin finish, single lens. Pushbutton on/ off. 4-1/2" X 3-1/2" -0 ..... **\$79.00 EA** ⚠️

## Dome Lights, cont.

**SMP22053B** .....ALL  
Plastic black finish. Double lens. Pushbutton on/ off. 7-7/8" X 3-9/16", mounting depth 1-1/4". -0.15 ..... **\$35.00 EA** ⚠️

**SMP22053P** .....ALL  
Polished finish double lens. Pushbutton on/ off. 7-7/8" X 3-9/16", mounting depth 1-1/4". -0 ..... **\$106.75 EA** ⚠️

**SMP22053S** .....ALL  
Satin finish double lens. Pushbutton on/ off. 7-7/8" X 3-9/16", mounting depth 1-1/4". -0 ..... **\$95.00 EA** ⚠️

**WASL82** .....ALL  
4-1/2" x 2-1/2" rectangular light with tan plastic bezel. Switched light with convenient push on-off switch built into the lens. Includes template, bulbs and 24" wire lead. 12 volt. -0.15 ..... **\$59.25 EA** ⚠️

**SMP22052P** .....ALL  
Polished finish, single lens. Pushbutton on/ off. 4-1/2" X 3-1/2" -0 ..... **\$89.25 EA** ⚠️

**SMP22052S** .....ALL  
Satin finish, single lens. Pushbutton on/ off. 4-1/2" X 3-1/2" -0 ..... **\$79.00 EA** ⚠️

**SMP22053B** .....ALL  
Plastic black finish. Double lens. Pushbutton on/ off. 7-7/8" X 3-9/16", mounting depth 1-1/4". -0.15 ..... **\$35.00 EA** ⚠️

**SMP22053P** .....ALL  
Polished finish double lens. Pushbutton on/ off. 7-7/8" X 3-9/16", mounting depth 1-1/4". -0 ..... **\$106.75 EA** ⚠️

**SMP22053S** .....ALL  
Satin finish double lens. Pushbutton on/ off. 7-7/8" X 3-9/16", mounting depth 1-1/4". -0 ..... **\$95.00 EA** ⚠️

**WASL82** .....ALL  
4-1/2" x 2-1/2" rectangular light with tan plastic bezel. Switched light with convenient push on-off switch built into the lens. Includes template, bulbs and 24" wire lead. 12 volt. -0.15 ..... **\$59.25 EA** ⚠️

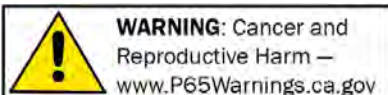

NOTE: Any chemicals will be shipped domestic ground only (Lower 48 states only). No international shipping.

(800) 952-1752 • www.streetrodhq.com

**Interior Lights**

These stylish non-switched interior lights can be used as door courtesy lights, rear quarter light, trunk light or anywhere you need additional lighting. Billet Aluminum Bezels. 12 volt.



**30658 . . . . .ALL**  
Vintage Style. Reddish-Purple Lens Helps Protect Night Vision. Reduces Glare from Oncoming Traffic. Functions As Reading

Or Accent Light. 12 Volt 1.000 -0.15  
..... **\$12.00 EA** ⚠



**BWDL . . . . .ALL**  
Billet Aluminum w/ brushed finish. -0.15

..... **\$52.69 EA** ⚠



**SMP22050P . . . . .ALL**  
Polished oval. 1-7/8" X 3-5/8"  
2" mounting depth -0.15

..... **\$48.00 EA** ⚠



**SMP22050S . . . . .ALL**  
Brushed/ satin oval. 1-7/8" X 3-5/8"  
2" mounting depth -0.15

..... **\$43.00 EA** ⚠



**SMP22051P . . . . .ALL**  
Polished teardrop. 3-1/8" X 1-7/8"  
mounting depth

2". -0.15



**SMP22051S . . . . .ALL**  
Satin/ Brushed teardrop. 3-1/8" X 1-7/8" mounting depth 2". -0.15

..... **\$43.00 EA** ⚠



**WASL53N . . . . .ALL**

Stylish lights for interior use. 1-7/8" x 1-3/8", snap in from behind the panel. Clear lens body is internally plated for reflectivity, with twist in socket (for use with #194 clear bulbs, included). Waterproof (not recommended for taillight or turn signal use). -0.15 **\$26.00 PR** ⚠

**Mirrors - Fatties Super View**

Fatties mirror heads multiply the view 800%, reduces night glare 80%, absorbs vibration, and eliminates blind spots! They are show polished CNC machined aluminum and have smooth action pivots.



**HAGM-OVH . . . . .ALL**  
4-1/2" X 1-3/4" Polished Oval head  
10.185 -0.15 ..... **\$89.09 EA** ⚠



**HAGM-RH . . . . .ALL**  
3-1/2" Polished Round head 10.185 -0.15  
..... **\$89.09 EA** ⚠



**HAGM-RH4 . . . . .ALL**  
4" Polished Round head 10.185 -0.15  
..... **\$89.25 EA** ⚠



**HAGM-RTH . . . . .ALL**  
4-1/2" X 1-3/4" Polished Rectangle head  
10.185 -0.15 ..... **\$89.25 EA** ⚠

**Mirror Arms Fatties Super View**



**HAGM-ARM-C . . . . .ALL**  
Mirror arms. 5-1/2" long. 10-24 thread. Curved. 10.185 -0.15

..... **\$89.25 PR** ⚠



**HAGM-ARM-L . . . . .ALL**  
Mirror arms. 5-1/2" long. 10-24 thread. 10.185 -0.15

..... **\$79.25 PR** ⚠

**Mirror Arms Fatties Super View, cont.**



**HAGM-ARM-N . . . . .ALL**  
Mirror arms. 5-1/2" long. 10-24 thread. Curved Noodle style.

10.185 -0.15 ..... **\$89.09 PR** ⚠



**HAGM-ARM-S . . . . .ALL**  
Mirror arms. 3-1/2" long. 10-24 thread. 10.185 -0.15

..... **\$79.00 PR** ⚠



**HAGM-ARM-WING . . . . .ALL**  
Mirror arms. 5-1/2" long. 10-24 thread. Curved. 10.185 -0.15

..... **\$135.19 PR** ⚠



**HAGM-B . . . . .ALL**  
Peep mirror arm adapter to run Fattie mirrors on your existing arms. 10.185 -0.15

..... **\$32.00 EA** ⚠



**HAGM-POST . . . . .ALL**  
Mirror post mount 1-3/4" tall with 10-24 threads for mirror. 10.185 -0.15

..... **\$37.00 EA** ⚠



**HAGM-POST-L . . . . .ALL**  
Mirror post mount 3-1/4" tall with 10-24 threads for mirror. Mounting holes are 1-7/16" center to center. 10.185 -0.15

..... **\$42.09 EA** ⚠



**HAGM-WS-P . . . . .ALL**  
Mirror windshield mount with 10-24 threads for mirror. Includes glass adhesive. 10.185 -0.15

..... **\$32.00 EA** ⚠

**Side Mirrors - Exterior Billet Heads & Arms**

Add timeless style with Billet Specialties forged 6061-T6 aluminum Profile Mirror Kits. Forged for ultimate strength, 3-D machined and mirror polished for style. Profile mirror arms feature multiple mounting holes for a secure fit and can be used for top or bottom mount applications.

**Side Mirrors -Exterior Billet Heads & Arms, cont.**



**BIS74120** .....ALL  
Round mirror heads with arms, 3-1/8" diameter, sold as a complete set.  
10.185 -0.15 ..... **\$225.00 SET** ⚠



**BIS74520** .....ALL  
Oval mirror head with arms, sold as a complete set. 10.185 -0.15  
..... **\$225.25 SET** ⚠



**BIS74720** .....ALL  
Offset round mirror heads with arms, 4" diameter, sold as a complete set.  
10.185 -0.15 ..... **\$225.00 SET** ⚠



**BIS74820** .....ALL  
Oblique mirror heads with arms, sold as a complete set. 10.185 -0.15  
..... **\$225.25 SET** ⚠

**Mirror -Rear View Autodimming**

Current day technology for convenient night driving. Fully automatic electrochromatic auto-dimming mirrors. Full range dimming capability from 75% down to 6%. Disabled dimming during daylight. See specific mirror specs for full range of options available.

**Mirror -Rear View Autodimming, cont.**



**GENK2** .....ALL  
Autodimming only. 10.185 -0.15  
..... **\$99.00 EA** ⚠



**GENK20** .....ALL  
Autodimming w/ digital compass & outside temp display. Ice alert warning below 38°. 10.185 -0.15 ..... **\$249.39 EA** ⚠



**GENK3350S** .....ALL  
Rearview Mirror - Auto Dimming With 3.3" Rear Camera Display, Homelink Remote Control (garage, gate, etc), Compass & Temp Gauge -0.15  
..... **\$729.00 EA** ⚠



**GENK5** .....ALL  
Autodimming w/ digital compass. 10.185 -0.15 ..... **\$179.19 EA** ⚠



**GENK50** .....ALL  
Autodimming w/ digital compass & outside temp display. Ice alert warning below 38°. Toss your remotes with this units Homelink. Replaces up to 3 RF controllers (garage, gate, etc). 10.185 -0.15  
..... **\$399.00 EA** ⚠



**GENKBTN** .....ALL  
Mirror mounting button. No cost option. 10.185 -0.15 ..... **\$6.49 EA** ⚠

**Mirror -Rear View Autodimming, cont.**

**GENKCVRS** ..... ALL  
Black wire cover. Short. 10.185 -0.15  
..... **\$3.59 EA** ⚠  
**VN2219LP** .....ALL  
License Plate Bar Camera For Use With Rear View Mirror W/ Camera Display -0.15  
..... **\$139.00 EA** ⚠



**Rear View Mirrors (Billet Specialties)**



**BIS257330** .....ALL  
Ball milled, billet aluminum rear view mirror. Unique beveled edge with a new universal fit design. 10.185 -0.15  
..... **\$80.00 EA** ⚠



**BIS257340** .....ALL  
Ball milled with Bowtie, billet aluminum rear view mirror. Unique beveled edge with a new universal fit design. 10.185 -0.15  
..... **\$80.00 EA** ⚠

**Rear View Mirrors**



**R6065** .....ALL  
Polished aluminum "rectangle with ball mill lines" interior mirror. Includes adjustable mount. -0.15 ..... **\$53.29 EA** ⚠



**R6065X** .....ALL  
Chrome interior mirror for car or truck - day/night switch. Includes adjustable mount. -0.15 ..... **\$34.50 EA** ⚠

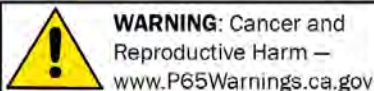

**WARNING: Cancer and Reproductive Harm** —  
www.P65Warnings.ca.gov

NOTE: Any chemicals will be shipped domestic ground only (Lower 48 states only). No international shipping.



**Rear View Mirrors, cont.**



**R6160**.....ALL  
 Chrome steel universal interior mirror with day/night switch - red flame. Includes adjustable mount. -0.15 . . \$35.25 EA ⚠



**R6161**.....ALL  
 Chrome Steel Universal Interior Mirror with Day/Nite Switch - Blue Flame. Includes adjustable mount. -0.15 . . \$34.09 EA ⚠



**R6163**.....ALL  
 Chrome steel universal interior mirror with day/night switch - black flame. Includes adjustable mount. -0.15 . . \$32.75 EA ⚠



**R6612**.....ALL  
 Chrome 5" wide, oval rear view mirror with mounting flange. -0.15 . . . \$47.25 EA ⚠



**R6613**.....ALL  
 Chrome 5" wide, oval rear view mirror with mounting flange. -0.15 . . . \$48.25 EA ⚠



**R6616**.....ALL  
 Chrome 5" oval rear view mirror - screw on style. -0.15 . . . \$29.09 EA ⚠

**Mirror-Rear View**



**R6619**.....ALL  
 Chromed aluminum "eagle" interior mirror. includes adjustable mount. -0.15 . . . \$60.49 EA ⚠



**R6619POL**.....ALL  
 Polished aluminum "eagle" interior mirror. Includes adjustable mount. -0.15 . . . \$48.79 EA ⚠

**Mirror Heads -Exterior or Interior (Billet Specialties)**

Note: These Mirror heads & arms are sold separately. Use arms HAGM-ARM or Billet Specialties interior mirror mounts. Use heads for side or interior rear view mirrors.



**BIS73420**.....ALL  
 Rectangular large (1-3/4" x 5-1/4") (arms sold separately). Can also be used as rear view mirror. Order bolt on or glue on rear view mount. 10.185 -0.15 . \$46.50 EA ⚠



**BIS73520**.....ALL  
 Oval (2-5/16" x 4-3/16") (arms sold separately). Can also be used as rear view mirror. Order bolt on or glue on rear view mount. 10.185 -0 . . . \$50.19 EA ⚠

**Interior Rear View Mirror Mount**



**4601549**.....53-54  
 Rear view mirror mount for htp and conv 10.185 -0.4 . . . \$20.00 EA ⚠



**BIS72120**.....ALL  
 Glue on for Billet Specialties rear view mirrors. 10.185 -0.15 . . . \$17.00 EA ⚠

**Interior Rear View Mirror Mount, cont.**



**BIS72220**.....ALL  
 Bolt on for Billet Specialties rear view mirrors. 2" center-to-center. 10.185 -0.15 . . . \$18.59 EA ⚠

**Mirror-Exterior**



**987460**.....52-54  
 Body mount w/ mounting pad (original 55-57). 10.185 -0.15 . . . \$23.50 EA ⚠



**987460L**.....52-54  
 Body mount w/ mounting pad (original 55-57). With build in LED arrow. 10.185 -0.15 . . . \$36.89 EA ⚠

**Mirrors -Exterior Billet Heads & Arms**



**BIS74920**.....ALL  
 Offset oval mirror head with arms, sold as a complete set. 10.185 -0.15 . . . \$225.25 SET ⚠

**Swan Neck Side Mirrors**



**R6615**.....ALL  
 Stainless 4" "swan neck" street rod mirrors (2 stud). -0.15 . . . \$51.25 PR ⚠

**King Bee Mirrors**



**4101972A**.....37-50  
 Left side. Clamp-on. Fits Coupe & Sedan. 10.185 -0.15 . . . \$83.50 EA ⚠

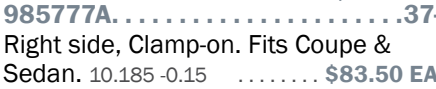

**985777A**.....37-50  
 Right side, Clamp-on. Fits Coupe & Sedan. 10.185 -0.15 . . . \$83.50 EA ⚠

**King Bee Mirrors, cont.**



**515848A** .....**.37-54**  
 Left side. 4-1/2in. (40-47 were originally 4in. ). Fits 49-54 Sedan Delivery, 48-50 Convertible & Hardtop. Mounting holes= 2" on center. 10.185 -0.15 ..... **\$76.25 EA** ⚠

**986305A** .....**.37-54**  
 Right side. 4-1/2in. (40-47 were originally 4in. ). Fits 49-54 Sedan Delivery, 48-50 Convertible & Hardtop. 10.185 -0.15 ..... **\$76.25 EA** ⚠



**515871A** .....**.ALL**  
 Clamp for King Bee mirror. Fits Coupe & Sedan. 10.185 -0.15 ..... **\$7.00 EA** ⚠

**Peep Mirrors**



**985235A** .....**.37-54**  
 Original 40-50, less GM script, left. 10.185 -0.15 ..... **\$19.50 EA** ⚠



**985231A** .....**.ALL**  
 Original era. 3in. round. Fits left or right. 10.185 -0.15 ..... **\$15.00 EA** ⚠



**985231B** .....**.ALL**  
 Original era. 4in. round. Fits left or right. 10.185 -0.15 ..... **\$15.00 EA** ⚠

**Peep Mirrors, cont.**



**985231BL** .....**.ALL**  
 Original era. 4in. round. Now with built in LED arrow for signal. Fits left or right. 10.185 -0.15 ..... **\$25.00 EA** ⚠



**985231E** .....**.ALL**  
 Extension for peep, moves mirror head out 1-1/2" to increase visibility and safety 10.185 -0.15 ..... **\$11.50 EA** ⚠



**985231SS** .....**.ALL**  
 Stainless visor for 4" Peep mirrors. 10.185 -0.15 ..... **\$9.50 EA** ⚠



**R6609** .....**.ALL**  
 Chrome 4" peep mirror - long arm (driver or passenger). -0.15 ..... **\$24.75 EA** ⚠



**R6610** .....**.ALL**  
 Chrome 4" peep mirror - short arm (driver or passenger). -0.15 ..... **\$24.00 EA** ⚠



**R6611** .....**.ALL**  
 Chrome universal 4.5" round mirror - straight arm (driver or passenger). -0.15 ..... **\$23.00 EA** ⚠

**Side Mirrors -ABS**

1-piece durable urethane plastic construction. Sandable & paintable. Fully adjustable mirror surface. Features solid trimable mounting stems. Includes mounting hardware & instructions for inside hidden mount or exterior mount. 2 versions with LED signal/ marker light.



**VHRINDY** .....**.ALL**  
 Rectangular. -0.15 ..... **\$160.00 SET** ⚠



**VHRVF1** .....**.ALL**  
 Teardrop. -0.15 ..... **\$160.25 SET** ⚠

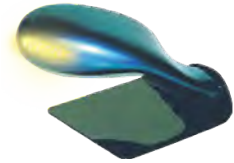

**VHRVF1-LED** .....**.ALL**  
 Teardrop w/ LED side light. -0.15 ..... **\$201.75 SET** ⚠

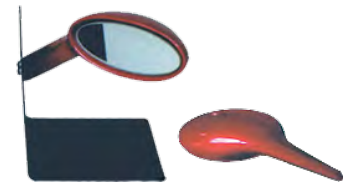

**VHRVF2** .....**.ALL**  
 Oval. -0.15 ..... **\$160.25 SET** ⚠



**VHRVF2-LED** .....**.ALL**  
 Oval w/ LED side light. -0.15 ..... **\$201.75 SET** ⚠



**WARNING: Cancer and Reproductive Harm** —  
[www.P65Warnings.ca.gov](http://www.P65Warnings.ca.gov)

NOTE: Any chemicals will be shipped domestic ground only (Lower 48 states only). No international shipping.

**Side Mirrors -ABS, cont.**



**VHRVF4.....ALL**  
Large oval. -0.15 ..... **\$180.25 SET** ⚠️  
**Side Mirrors**



**R6606.....ALL**  
"California Classic" mirrors with LED turn signals. Universal application. -0.15  
..... **\$65.00 PR** ⚠️



**R6607.....ALL**  
"California Classic" mirrors. Universal application. -0.15 ..... **\$60.25 PR** ⚠️

**Digital Gauges (Dakota Digital) -Dimmer**



**DIM1.....ALL**  
Dimmer switch for Dakota Digital dash displays. Rotary control with aluminum knob. 2.485 -0.15

..... **\$29.99 EA** ⚠️

**Digital Gauges (Dakota Digital) 37-38 Chevy Car**



**1562830G.....37-38**  
VFD system. panel dimensions 12" x 4" 10.230 -0.15 ..... **\$675.00 SET** ⚠️



**4073755AC.....37-38**  
Aluminum glove box door. Brushed finish. 10.260 -0.15 ..... **\$115.09 EA** ⚠️



**4073755AD.....37-38**  
Aluminum glove box door w/ VFD clock. Brushed finish. 10.260 -0.15

..... **\$195.00 EA** ⚠️



**595585A.....37-38**  
Aluminum radio panel (w/ radio shaft holes). 10.260 -0.15

..... **\$100.00 EA** ⚠️



**595585AD.....37-38**  
Aluminum radio panel w/ A/C vent. Brushed finish. 10.230 -0.15

..... **\$105.00 EA** ⚠️

**Digital Gauges (Dakota Digital) 39 Chevy Car**



**1564497G.....39**  
VFD system (panel dimensions 12in. x 4in. ). 10.230 -0.15 ..... **\$675.00 SET** ⚠️



**4089940AD.....39**  
Aluminum glove box door w/ VFD clock. Smooth, brushed finish. 10.260 -0.15 ..... **\$180.00 EA** ⚠️

**Digital Gauges (Dakota Digital) 40 Chevy Car**



Shown installed in stock bezel (not included)

**1565308GD.....40**  
VFD system direct fit kit (panel dimensions 12in. x 4in. ). Fits into dash w/out modification. Uses original dash trim. 10.230 -0.15 ..... **\$675.00 SET** ⚠️

**Digital Gauges (Dakota Digital) 41-48 Chevy Car**



**1566356G.....41-48**  
Five-gauge system (panel dimensions 14.8in. x 5in. ). 10.230 -0.15 ..... **\$685.69 SET** ⚠️

**Digital Gauges (Dakota Digital) 49-52 Chevy Car**



**1568623G** ..... **49-50**  
 VFD system, Full 6 Gauge Instrument System fits stock dash housing of 1949-50 Chevy. Bezel not included. 10.230 -0.15  
 ..... **\$650.00 SET** ⚠

**Digital Gauges (Dakota Digital) 53-54 Chevy Car**



**1581308G** ..... **53-54**  
 VFD system with five gauges. Mounts into stock instrument bezel. 10.230 -0.15  
 ..... **\$685.00 SET** ⚠

**Digital Gauges (Dakota Digital) 37-38 Ford Car**



**ALG-37** ..... **37-38**  
 Billet aluminum glove box door. -0.15  
 ..... **\$105.00 EA** ⚠



**ALR-37** ..... **37-38**  
 Billet aluminum radio panel (shaft radio). -0.15  
 ..... **\$90.00 EA** ⚠



**VFD3-37F** ..... **37-38**  
 5 gauge VFD system with billet aluminum panel. -0.15  
 ..... **\$675.00 SET** ⚠

**Digital Gauges (Dakota Digital) 39 Ford Car**



**ALC-39-CLK** ..... **39**  
 Billet aluminum clock panel w/ VFD clock. -0.15  
 ..... **\$135.00 EA** ⚠

**Digital Gauges (Dakota Digital) 39 Ford Car, cont.**



**ALR-39** ..... **39**  
 Billet aluminum radio panel (shaft radio). -0.15

..... **\$65.00 EA** ⚠



**VFD3-39F** ..... **39**  
 5 gauge VFD system with billet aluminum panel. -0.15  
 ..... **\$675.00 SET** ⚠

**Digital Gauges (Dakota Digital) 40 Ford Car**



**ALC-40-CLK** ..... **40**  
 Billet aluminum clock panel with VFD clock. -0.15  
 ..... **\$140.00 EA** ⚠



**ALR-40** ..... **40**  
 Billet aluminum radio panel (shaft radio). -0.15

..... **\$70.00 EA** ⚠



**VFD3-40F** ..... **40**  
 5 gauge VFD system with billet aluminum panel. -0.15  
 ..... **\$675.00 SET** ⚠

**Digital Gauges (Dakota Digital) 41 Ford Car**



**VFD3-41F-0** ..... **41**  
 6 gauge VFD system. Fits stock dash. -0.15  
 ..... **\$675.00 SET** ⚠

**Digital Gauges (Dakota Digital) 41 Ford Car, cont.**



**VFD3-41F-PR** ..... **41**  
 6 gauge VFD system. Fits stock bezel/housing (not included). -0.15  
 ..... **\$685.00 SET** ⚠

**Digital Gauges (Dakota Digital) 42-48 Ford Car**



**ALC-42-CLK** ... **42-48**  
 Billet aluminum panel with VFD clock. -0.15

..... **\$195.19 EA** ⚠



**VFD3-42F-0** ..... **42-48**  
 5 gauge VFD system with billet aluminum panel. -0.15  
 ..... **\$675.69 SET** ⚠

**Digital Gauges (Dakota Digital) 51 Ford Car**



**VFD3-51F** ..... **51**  
 6 gauge VFD system fits into stock dash housing. -0.15  
 ..... **\$635.00 SET** ⚠

**Digital Gauges (Dakota Digital) - Universal**



**VFD3-1000-L** ..... **ALL**  
 5 gauge VFD system. Dimensions; Unit 14" x 4.3", Min viewing area 13" x 3". -0.15  
 ..... **\$595.00 SET** ⚠

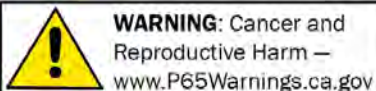

NOTE: Any chemicals will be shipped domestic ground only (Lower 48 states only). No international shipping.

**Digital Gauges (Dakota Digital) - Universal, cont.**



**VFD3-1001-L** .....ALL  
6 gauge VFD system. Dimensions; Unit 18.5" x 4.4", Min viewing area 17" x 3". -0.15  
..... **\$685.00 SET** ⚠



**VFD3-1004** .....ALL  
Round 6 gauge VFD system with triple chrome plated bezels. Dimensions; Unit 4.5" Dia., Bezels 4.75" dia. -0.15  
..... **\$725.00 SET** ⚠



**VFD3-1008** .....ALL  
6 gauge oval VFD system w/ chrome bezel. Dimensions 12" x 4.25". -0.15  
..... **\$795.00 SET** ⚠



**VFD3-CNTR-5** .....ALL  
5 gauge VFD system with billet aluminum dash panel. Dimensions 14.5" x 4". -0.15  
..... **\$675.00 SET** ⚠



**VFD3-REC-5** .....ALL  
5 gauge VFD system with billet aluminum dash panel. Dimensions 14.5" x 4". -0.15  
..... **\$675.00 SET** ⚠



**VFD3-SIDE-5** .....ALL  
5 gauge VFD system with billet aluminum dash panel. Dimensions 14.5" x 4". -0.15  
..... **\$625.00 SET** ⚠

**Digital Gauges (Dakota Digital) - Universal, cont.**



**VFD3-SIDE-6** .....ALL  
6 gauge VFD system with billet aluminum dash panel. Dimensions 18" x 4". -0.15  
..... **\$725.00 SET** ⚠



**VFD3X-1002** .....ALL  
6 gauge VFD system. Dimensions; Unit 18.5" x 4.4", Min viewing area 17" x 3". -0.15  
..... **\$665.00 SET** ⚠



**VFD3X-1002B** .....ALL  
6 gauge oval VFD system w/ brushed aluminum bezel. Dimensions; Unit 19" x 3.5", Bezel 19" x 2". -0.15  
..... **\$715.00 SET** ⚠



Shown installed in T-Bucket

**VFD3X-1002B-C** .....ALL  
6 gauge oval VFD system w/ chrome bezel. Dimensions; Unit 19" x 3.5", Bezel 19" x 2". -0.15  
..... **\$775.00 SET** ⚠

**Digital Gauges (Dakota Digital) Chevy Truck**



**VHX-47C-PU-C-B** .....47-53  
VHX system with chrome bezel. Carbon fiber style face. Blue backlight. 10.230-0.15  
..... **\$795.00 SET** ⚠

**Digital Gauges (Dakota Digital) Chevy Truck, cont.**



**VHX-47C-PU-S-B** .....47-53  
VHX system with chrome bezel. Silver alloy style face. Blue backlight. 10.230-0.15  
..... **\$795.00 SET** ⚠



**VHX-54C-PU-C-B** .....54  
VHX system with chrome bezel and carbon fiber style face. Blue backlight. 10.230-0.15  
..... **\$795.00 SET** ⚠



**VHX-54C-PU-S-B** .....54  
VHX system with chrome bezel and silver alloy style face. Blue backlight. 10.230-0.15  
..... **\$795.00 SET** ⚠

**Digital Gauges (Dakota Digital) Ford Truck**



**VFD3-40F-PU** .....40-46  
5 gauge VFD system with billet aluminum dash panel. -0.15  
..... **\$675.00 SET** ⚠



**VFD3-48F-PU** .....48-50  
5 gauge VFD system with billet aluminum dash panel. -0.15  
..... **\$675.00 SET** ⚠

**Digital Gauges (Dakota Digital)  
Ford Truck, cont.**



**VFD3-51F-PU** .....51-52  
5 gauge VFD system includes chrome bezels. -0.15 ..... **\$725.00 SET** ⚠



**VFD3-53F-PU-A** .....53-55  
5 gauge VFD system with billet aluminum dash panel. -0.15 ..... **\$675.00 SET** ⚠

**VHX SERIES - Digital Gauges  
(Dakota Digital) Chevy Truck**



**VHX-47C-PU-C-R** .....47-53  
VHX system with chrome bezel. Carbon fiber style face. Red backlight. 10.230 -0.15 ..... **\$795.00 SET** ⚠



**VHX-47C-PU-S-R** .....47-53  
VHX system with chrome bezel. Silver alloy style face. Red backlight. 10.230 -0.15 ..... **\$795.79 SET** ⚠



**VHX-54C-PU-C-R** ..... 54  
VHX system with chrome bezel and carbon fiber style face. Red backlight. 10.230 -0.15 ..... **\$795.00 SET** ⚠

**VHX SERIES - Digital Gauges  
(Dakota Digital) Chevy Truck, cont.**



**VHX-54C-PU-S-R** ..... 54  
VHX system with chrome bezel and silver alloy style face. Red backlight. 10.230 -0.15 ..... **\$795.00 SET** ⚠

**VHX SERIES - Digital Gauges  
(Dakota Digital) - Universal**



**VHX-1013-C-B** .....ALL  
VHX system with chrome bezel. Carbon fiber style face. Blue backlight. 10.230 -0.15 ..... **\$795.00 SET** ⚠

**VHX-1013-C-R** ....ALL  
VHX system with chrome bezel. Carbon fiber style face. Red backlight. 10.230 -0.15 ..... **\$795.00 SET** ⚠

**VHX-1013-S-B** ....ALL  
VHX system with chrome bezel. Carbon fiber style face. Blue backlight. 10.230 -0.15 ..... **\$795.00 SET** ⚠



**VHX-1013-S-R** .....ALL  
VHX system with chrome bezel. Carbon fiber style face. Red backlight. 10.230 -0.15 ..... **\$795.00 SET** ⚠



**VHX-1014-C-B** .....ALL  
VHX system with chrome bezel. Carbon fiber style face. Blue backlight. 10.230 -0.15 ..... **\$795.00 SET** ⚠

**VHX SERIES - Digital Gauges  
(Dakota Digital) - Universal, cont.**



**VHX-1014-C-R** .....ALL  
VHX system with chrome bezel. Carbon fiber style face. Red backlight. 10.230 -0.15 ..... **\$795.00 SET** ⚠



**VHX-1014-S-B** .....ALL  
VHX system with chrome bezel. Carbon fiber style face. Blue backlight. 10.230 -0.15 ..... **\$795.00 SET** ⚠



**VHX-1014-S-R** .....ALL  
VHX system with chrome bezel. Carbon fiber style face. Red backlight. 10.230 -0.15 ..... **\$795.00 SET** ⚠

**VHX-1015-C-B** ....ALL  
VHX system with chrome bezel. Carbon fiber style face. Blue backlight. 10.230 -0.15 ..... **\$795.00 SET** ⚠

**VHX-1015-C-R** ....ALL  
VHX system with chrome bezel. Carbon fiber style face. Red backlight. 10.230 -0.15 ..... **\$795.00 SET** ⚠

**VHX-1015-S-B** ....ALL  
VHX system with chrome bezel. Carbon fiber style face. Blue backlight. 10.230 -0.15 ..... **\$795.00 SET** ⚠

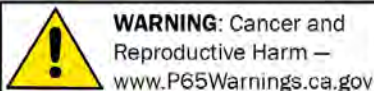

NOTE: Any chemicals will be shipped domestic ground only (Lower 48 states only). No international shipping.

**VHX SERIES - Digital Gauges (Dakota Digital) - Universal, cont.**



**VHX-1015-S-R** .....ALL  
VHX system with chrome bezel. Carbon fiber style face. Red backlight. 10.230 -0.15  
..... **\$795.00 SET** ⚠️



**VHX-1020-C-B** .....ALL  
VHX system with chrome bezel. Carbon fiber style face. Blue backlight. 10.230 -0.15  
..... **\$845.00 SET** ⚠️



**VHX-1020-C-R** ....ALL  
VHX system with chrome bezel. Carbon fiber style face. Red backlight. 10.230 -0.15  
..... **\$845.00 SET** ⚠️



**VHX-1020-S-B** ....ALL  
VHX system with chrome bezel. Carbon fiber style face. Blue backlight. 10.230 -0.15  
..... **\$845.00 SET** ⚠️



**VHX-1020-S-R** ....ALL  
VHX system with chrome bezel. Carbon fiber style face. Red backlight. 10.230 -0.15  
..... **\$845.00 SET** ⚠️

**VHX SERIES - Digital Gauges (Dakota Digital) Chevy Car**



**1568623VHX-C-B** .....49-50  
VHX system, Full 6 Gauge Instrument System, Carbon Fiber Style Face and Blue backlighting. Fits stock dash housing of 1949-50 Chevy. Bezel not included. 10.230 -0.15  
..... **\$795.79 SET** ⚠️

**VHX SERIES - Digital Gauges (Dakota Digital) Chevy Car, cont.**



**1568623VHX-C-R** .....49-50  
VHX system Full 6 Gauge Instrument System, Carbon Fiber Style Face and Blue backlighting. Fits stock dash housing of 1949-50 Chevy. Bezel not included. 10.230 -0.15  
..... **\$795.00 SET** ⚠️



**1568623VHX-S-B** .....49-50  
VHX system Full 6 Gauge Instrument System, Alloy Style Face and Blue backlighting. Fits stock dash housing of 1949-50 Chevy. Bezel not included. 10.230 -0.15  
..... **\$795.00 SET** ⚠️

**1568623VHX-S-R** .....49-50  
VHX system Full 6 Gauge Instrument System, Alloy Style Face and Red backlighting. Fits stock dash housing of 1949-50 Chevy. Bezel not included. 10.230 -0.15  
..... **\$795.00 SET** ⚠️



**1581308VHX-K-B** .....53-54  
VHX system with six gauges. Black Alloy Face and Blue Backlight. Mounts into stock instrument bezel. 10.230 -0.15  
..... **\$795.00 SET** ⚠️



**1581308VHX-K-R** .....53-54  
VHX system with six gauges. Black Alloy Face and Red Backlight. Mounts into stock instrument bezel. 10.230 -0.15  
..... **\$795.00 SET** ⚠️

**VHX SERIES - Digital Gauges (Dakota Digital) Chevy Car, cont.**



**1581308VHX-S-B** .....53-54  
VHX system with six gauges. Silver Alloy Face and Blue Backlight. Mounts into stock instrument bezel. 10.230 -0.15  
..... **\$795.00 SET** ⚠️



**1581308VHX-S-R** .....53-54  
VHX system with six gauges. Silver Alloy Face and Red Backlight. Mounts into stock instrument bezel. 10.230 -0.15  
..... **\$795.79 SET** ⚠️

**Auto Meter Gauges -Chevy Vintage Series**

Auto Meter Chevy Vintage Series 5 gauge set. White face, orange needles. 3-3/8" dia speedo w/ 2-1/16" dia. auxiliary gauges.

**Auto Meter Gauges**

Tachs for the following Auto Meter gauges work with most 4, 6 & 8 cylinder engines and most Std Points and Elect. Ignitions.

**Auto Meter Gauges -Ford Masterpiece Series**



**F880087** .....ALL  
5 gauge set  
160mph 3-3/8" dia. Speedo (electric programmable)  
2-1/8" dia. auxiliary gauges; Oil Press (electric), Water Temp, Volts & Fuel Level. -0.15  
..... **\$479.00 SET** ⚠️

**Auto Meter Gauges -American Muscle Series**

These unique gauges feature hybrid metal dials, illuminated pointers and HI-DEF0 visibility for unmatched day and night visibility. (gauges only, shown mounted in billet panel-sold separately)

**Auto Meter Gauges -American Muscle Series, cont.**



**AM1202** .....ALL  
 Embossed aluminum dials. 5 gauge, 3-3/8" speedo with 2-1/16" Fuel, Oil, Water & Volts. -0 ... **\$600.00 SET** ⚠

**AM1205** .....ALL  
 Embossed aluminum dials. 6-gauge, 5" Quad set. Electronic speedo with integrated 8,000 rpm tach. -0  
 ..... **\$700.00 SET** ⚠

**Auto Meter Gauges -Antique Beige Series**

The Street Rod Series of gauges from Auto Meter feature vintage styling with rugged air core movements. Many styles to choose from to fit a variety of tastes. They even offer a 3-3/8" Tach/ Speedo combo in most of the Street Rod line. Visit our web site for complete details and images.



**AB1800** .....ALL  
 3-3/8" Quad gauge and speedo set. -0.15  
 ..... **\$513.00 SET** ⚠



**AB1803** .....ALL  
 5" Quad Gauge & Speedo (Electric) set -0.15  
 ..... **\$595.00 SET** ⚠



**AB1820** .....ALL  
 3-3/8" Speedo Tach Combo & Quad Gauge Set -0.15  
 ..... **\$607.00 SET** ⚠

**Auto Meter Gauges -Old Tyme White II**



**OTW1200** .....ALL  
 3-3/8" 5 Gauge (Electric Speed) -0.15  
 ..... **\$550.00 SET** ⚠



**OTW1203** .....ALL  
 5" Speedo Tach Combo & Quad Gauge Set -0  
 ..... **\$650.00 SET** ⚠

**Auto Meter Gauges -Old Tyme White Series**

**OTW1600** .....ALL  
 3-3/8" quad gauge and speedo (electric) set. -0.15  
 ..... **\$513.00 SET** ⚠

**OTW1603** .....ALL  
 5" quad gauge and speedo (electric) set. -0.15  
 ..... **\$595.00 SET** ⚠



**OTW1620** .....ALL  
 3-3/8" speedo tach combo and quad gauge set. -0.15  
 ..... **\$607.00 SET** ⚠

**Auto Meter Gauges -Arctic White Series**

**AW1303** .....ALL  
 5" quad gauge and speedo (electric) set. -0.15  
 ..... **\$595.00 SET** ⚠

**AW1308** .....ALL  
 3-3/8" quad gauge and electronic speedo set. -0.15  
 ..... **\$513.00 SET** ⚠

**Auto Meter Gauges -Arctic White Series, cont.**



**AW1309** .....ALL  
 3-3/8" speedo tach combo and quad gauge set. -0.15  
 ..... **\$607.00 SET** ⚠

**Auto Meter Gauges -Designer Black**

**DB1403** .....ALL  
 5" quad gauge and electronic speedo set. -0.15  
 ..... **\$595.00 SET** ⚠

**DB1408** .....ALL  
 3-3/8" quad gauge and electronic speedo set. -0.15  
 ..... **\$513.00 SET** ⚠



**DB1409** .....ALL  
 3-3/8" speedo tach combo and quad gauge set. -0.15  
 ..... **\$607.00 SET** ⚠

**Auto Meter Gauges -Designer Black II**



**DB1201** .....ALL  
 3-3/8" 5 gauge kit (electronic speedo) -0.15  
 ..... **\$545.00 SET** ⚠



**DB1204** .....ALL  
 5" speedo tach combo and quad gauge set. -0  
 ..... **\$650.00 SET** ⚠

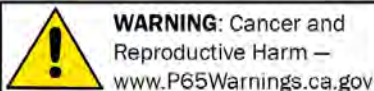

NOTE: Any chemicals will be shipped domestic ground only (Lower 48 states only). No international shipping.



**Auto Meter Gauges -Cruiser Series**

Hybrid metal dials, HI-DEF "through the dial" LED illumination and illuminated pointers for instant monitoring or your gauges.



**CRS1101** .....ALL  
Hybrid metal dials. 5 gauge, 3-3/8" speedo with 2-1/16" Fuel, Oil, Water & Volts. Includes speed sensor for most GM transmissions. -0.15

**\$641.25 SET** ⚠️

**Auto Meter Gauges -MCX Series**

Combining American Muscle heritage styling with chrome accents and Auto Meter's full dial, bright withie LED lighting. Black & White dials with high contrast orange pointers.



**MCX1103** .....ALL  
5 1/2" speedo tach combo and quad gauge set. -0.15

**\$700.00 SET** ⚠️

**Classic Instrument Direct Fit Gauges**



**FC40E** ..... 40  
1940 Ford Original Style 6 in 1 cluster. -0.15

**\$985.00 EA** ⚠️

**CT47CW62** .....47-53

1947-53 GM Pick-Up Package Classic White Series 4 5/8" Speedtachular (Speedometer/ Tachometer Combination) & Quad (Fuel 240-33 OHM) with Stainless Low Step Bezel Flat Glass Lens. The package includes model specific rings, mounting hardware, and all sending units. -0.15

**\$874.00 EA** ⚠️

**Classic Instrument Direct Fit Gauges, cont.**

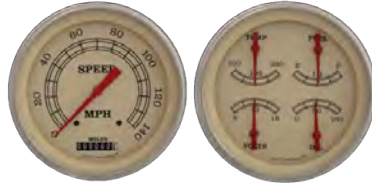

**CT47VT52** .....47-53  
1947-53 GM Pick-Up Package Vintage Series 4 5/8" Speedometer & Quad (Fuel 240-33 OHM) with Stainless Low Step Bezel Flat Glass Lens. The package includes model specific rings, mounting hardware, and all sending units. -0.15

**\$657.50 EA** ⚠️



**CH49T** .....49-50  
Classic Line Tan With Red Pointer Direct Fit -0.15

**\$986.75 EA** ⚠️



**CH51AN** .....51-52  
All American Nickle With Red Pointer Direct Fit -0.15

**\$939.00 EA** ⚠️



**CH51CW** .....51-52  
Classic White With Black Pointer -0.15

**\$780.00 EA** ⚠️



**CH51HR** .....51-52  
Hot Rod Series With White Pointer Direct Fit -0.15

**\$780.00 EA** ⚠️

**Classic Instrument Direct Fit Gauges, cont.**



**CH51V8S52** .....51-52  
V8 Red Steelie Direct Fit -0.15

**\$949.00 EA** ⚠️



**CH51VT** .....51-52  
Classic line Tan With Red Pointer Direct Fit -0.15

**\$780.00 EA** ⚠️

**BE01BB** .....55-56  
Bel Era Black 6-in-One Package Fuel 0-30 OHM

\* Bezel not included. Optional Gear Indicator Insert (upgrade) shown installed. -0.15

**\$846.00 EA** ⚠️



**TF01B** .....55-59

1955-59 Chevy Truck Black Tach Force Package. Features a dual layer design with 140 MPH Speedometer 8,000 RPM Tachometer, Fuel (0-30 OHM), Oil, Temp, and Volt with LED turn signals and high beam indicator. Package is completely assembled in bezel and includes wiring harness, installation hardware and all necessary sending units.

\*Fuel sending unit not included, fuel gauge is calibrated to stock 0-30 OHM. -0.15

**\$959.00 EA** ⚠️



**RT80SLF** .....ALL  
Rocket Tach 3 3/8" Tachometer 8000 RPM w/ Chrome Tach Cup with Stainless Low Step Bezel Flat Glass Lens -0.15

**\$208.00 EA** ⚠️

**Classic Instrument Direct Fit Gauges, cont.**



**SN16F**.....ALL  
Pulse Generator For Ford Transmissions W/ Speedo Cable Drives (Requires Driven Gear) -0.15 ..... **\$91.00 EA** ⚠

**Instrument Gauges -Hot Rod Series**



**HR00SLF** .....ALL  
5 Gauge Set. 140 mph speedo with odometer (3-3/8inch diameter). Separate Fuel, Temp, Volt & Oil Pressure gauges (2-1/8 inch diameter). Flat lens. 9.748 -0.15 ..... **\$565.00 EA** ⚠

**HR01SLF**.....ALL  
6 Gauge Set. 140 mph speedo with odometer (3-3/8 inch diameter), Tachometer (3-3/8 inch diameter). Separate Fuel, Temp, Volt & Oil Pressure gauges (2-1/8 inch diameter). 9.748 -0.15 ..... **\$687.00 SET** ⚠



**HR02SLC** .....ALL  
2 Gauge Set. 3-3/8 inch Speedo & standard quad-cluster. Curved lens. 9.748 -0.15 ..... **\$543.00 SET** ⚠



**HR02SLF** .....ALL  
2 Gauge Set. 3-3/8 inch Speedo & standard quad. Flat lens. 9.748 -0.15 ..... **\$531.00 EA** ⚠

**Instrument Gauges -Hot Rod Series, cont.**



**HR32SLC** .....ALL  
2 Gauge Set. 3-3/8 inch Ultimate Speedometer (Speedo-Tach combo) & quad cluster. Curved lens. 9.748 -0.15 ..... **\$688.00 EA** ⚠

**HR35SLF** .....ALL  
2 Gauge Set. 3-3/8 inch Ultimate Speedometer (Speedo-Tach combo) & quad cluster. Flat lens. 9.748 -0.15 ..... **\$725.00 SET** ⚠



**HR50SLF** .....ALL  
Speedo-Tach combo. Flat lens. 9.748 -0.15 ..... **\$618.00 EA** ⚠



**HR52SLC** .....ALL  
2 Gauge Set. 5 inch speedo & quad. Curved lens. 9.748 -0.15 ..... **\$644.00 EA** ⚠



**HR80SLF** .....ALL  
Tach 8000rpm. Flat lens. 9.748 -0.15 ..... **\$151.00 EA** ⚠



**HR90SLF**.....ALL  
0.000 -0.15 ..... **\$124.00 EA** ⚠

**Instrument Gauges -Hot Rod Series, cont.**



**HR93SLF** .....ALL  
Clock w/ reset button. Flat lens (3-3/8" dia.). 9.748 -0.15 ..... **\$152.75 EA** ⚠

**Instrument Gauges -All American Tradition Series**



**AT01SHC** .....ALL  
6 Gauge Set. 140 mph speedo with odometer & 8,000 rpm Tach (3-3/8 inch diameter). Separate Fuel, Temp, Volt & Oil Pressure gauges (2-1/8 inch diameter). Black back, silver machined insert with raised AAW logo. Polished stainless high step bezel, white tear drop pointer & curved lens. 5 year warranty. Includes all needed senders. 9.748 -0.15 ..... **\$791.00 SET** ⚠



**AT02SHC** .....ALL  
2 Gauge Set. 140 mph Speedo and 4-in-1 gauge with Fuel, Temp, Volt & Oil Pressure gauges, both 3-3/8 inch diameter. Black machined back. Polished stainless radial bezel, White tear drop pointer & curved lens. 5 year warranty. 9.748 -0.15 ..... **\$610.00 SET** ⚠



**AT52SLC** .....ALL  
0.000 -0.15 ..... **\$800.00 SET** ⚠

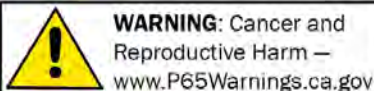

**WARNING:** Cancer and Reproductive Harm — [www.P65Warnings.ca.gov](http://www.P65Warnings.ca.gov)

NOTE: Any chemicals will be shipped domestic ground only (Lower 48 states only). No international shipping.

**Instrument Gauges -All American Tradition Series, cont.**



**AT62SLC**.....ALL  
0.000 -0.15 ..... **\$1,009.00 SET** ⚠



**AT80SRC**.....ALL  
Tach - 3-3/8" 8000 rpm  
- All American Tradition  
Series -0.15  
..... **\$181.00 EA** ⚠



**AT90SHC** .....ALL  
New Classic Instruments clock 2-1/8" with  
reset button - All American Tradition Series  
0.000 -0.15 ..... **\$199.00 EA** ⚠

**Instrument Gauges -Traditional Series**



**TR00SLF**.....ALL  
5 Gauge Set. 140 mph speedo with  
odometer (3-3/8 inch diameter). Separate  
Fuel, Temp, Volt & Oil Pressure gauges  
(2-1/8 inch diameter). Polished stainless  
radial bezel, black pointer & flat lens. 5  
year warranty. 9.748 -0.15  
..... **\$565.00 SET** ⚠



**TR02SLF**.....ALL  
2 Gauge Set. 3-3/8 inch Speedo &  
standard quad-cluster. 140 mph Speedo  
and 4-in-1 gauge with Fuel, Temp, Volt &  
Oil Pressure gauges, both 3-3/8 inch  
diameter. Polished stainless radial bezel,  
black pointer & flat lens. 5 year warranty.  
9.748 -0.15 ..... **\$531.00 SET** ⚠

**Instrument Gauges -Traditional Series, cont.**

**TR32SLF**.....ALL  
3-3/8" Speedo-Tach combo. Flat lens.  
9.748 -0.15  
..... **\$676.00 SET** ⚠



**TR50SLF**.....ALL  
Speedo-Tach combo. Flat lens. 9.748 -0.15  
..... **\$618.00 EA** ⚠

**Instrument Gauges -All American Series**



**AW00SRC**.....ALL  
5 Gauge Set. 140 mph speedo with  
odometer (3-3/8 inch diameter). Separate  
Fuel, Temp, Volt & Oil Pressure gauges  
(2-1/8 inch diameter). Silver machined  
back with raised AAW logo. Polished  
stainless radial bezel, black tear drop  
pointer & curved lens. 5 year warranty.  
9.748 -0.15 ..... **\$656.00 SET** ⚠



**AW01SRC**.....ALL  
6 Gauge Set. 140 mph speedo with  
odometer (3-3/8 inch diameter),  
Tachometer (3-3/8 inch diameter).  
Separate Fuel, Temp, Volt & Oil Pressure  
gauges (2-1/8 inch diameter). Silver  
machined back with raised AAW logo.  
Polished stainless radial bezel, black tear  
drop pointer & curved lens. 5 year  
warranty. 9.748 -0.15  
..... **\$791.00 SET** ⚠

**Instrument Gauges -All American Series, cont.**



**AW02SRC**.....ALL  
2 Gauge Set. 140 mph Speedo and 4-in-1  
gauge with Fuel, Temp, Volt & Oil Pressure  
gauges, both 3-3/8 inch diameter. Silver  
machined back with raised AAW logo.  
Polished stainless radial bezel, black tear  
drop pointer & curved lens. 5 year  
warranty. 9.748 -0.15  
..... **\$610.00 SET** ⚠



**AW50SRC**.....ALL  
Classic Instruments 5" Speedtacular  
Speedo-Tach Gauge - All American Series  
0.000 -0.15 ..... **\$678.00 EA** ⚠



**AW52SRC**.....ALL  
5 inch, 5 Gauge Set. 140 mph speedo with  
odometer (5 inch dia). Separate Fuel,  
Temp, Volt & Oil Pressure gauges (5 inch  
dia). Silver machined back with raised  
AAW logo. Polished stainless radial bezel,  
black tear drop pointer & curved lens. 5  
year warranty. 0.000 -0.15  
..... **\$800.00 SET** ⚠

**AW62SRC**.....ALL  
6 Gauge Set. 140 mph speedo with  
built-in 8,000RPM tach & odometer (5  
inch diameter). Separate Fuel, Temp, Volt  
& Oil Pressure gauges (5 inch diameter).  
Silver machined back with raised AAW  
logo. Polished stainless radial bezel, black  
tear drop pointer & curved lens. 5 year  
warranty. 0.000 -0.15  
..... **\$1,009.00 SET** ⚠

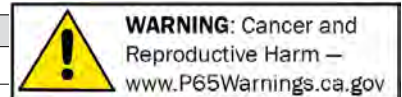

**Instrument Gauges -All American Nickel Series**



**AN00SHC** .....ALL  
 Five Gauge Set. 140 mph speedo with odometer (3-3/8 inch diameter). Separate Fuel, Temp, Volt & Oil Pressure gauges (2-1/8 inch diameter). Nickel appearance back with raised AAW logo. Polished stainless radial bezel, red tear drop pointer & curved lens. 5 year warranty. 9.748 -0.15 ..... **\$656.00 SET** ⚠



**AN01SHC** .....ALL  
 6 Gauge Set. 140 mph speedo with odometer (3-3/8 inch diameter), 8,000 rpm Tachometer (3-3/8 inch diameter). Separate Fuel, Temp, Volt & Oil Pressure gauges (2-1/8 inch diameter). Nickel appearance machined back with raised AAW logo. Polished stainless radial bezel, red tear drop pointer & curved lens. 5 year warranty. 9.748 -0.15 ..... **\$791.00 SET** ⚠



**AN02SHC** .....ALL  
 2 Gauge Set. 140 mph Speedo and 4-in-1 gauge with Fuel, Temp, Volt & Oil Pressure gauges, both 3-3/8 inch diameter. Nickel appearance back with raised AAW logo. Polished stainless stepped bezel, red tear drop pointer & curved lens. 5 year warranty. 9.748 -0.15 ..... **\$610.00 SET** ⚠

**Instrument Gauges -All American Nickel Series, cont.**



**AN50SLC** .....ALL  
 Classic Instruments Speedtacular (Speedo-Tach Combo), 5" - All American Nickel Series 0.000 -0.15 ..... **\$678.00 EA** ⚠



**AN52SLC** .....ALL  
 0.000 -0.15 ..... **\$800.00 SET** ⚠



**AN80SRC** .....ALL  
 Tach. 8000 rpm (3-3/8 inch diameter). Nickel appearance machined back with raised AAW logo. Polished stainless radial bezel, red tear drop pointer & curved lens. 5 year warranty. 9.748 -0.15 ..... **\$181.00 EA** ⚠



**AN90SHC** .....ALL  
 All American Nickel Series 2-1/8" clock with reset button. 0.000 -0.15 ..... **\$199.00 EA** ⚠

**Instrument Gauges -Vintage Series**



**VT00SLC** .....ALL  
 5 Gauge Set. 140 mph speedo with odometer (3-3/8 inch diameter). Separate Fuel, Temp, Volt & Oil Pressure gauges (2-1/8 inch diameter). Curved lens. 9.748 -0.15 ..... **\$588.00 SET** ⚠

**Instrument Gauges -Vintage Series, cont.**



**VT00SLF** .....ALL  
 5 Gauge Set. 140 mph speedo with odometer (3-3/8 inch diameter). Separate Fuel, Temp, Volt & Oil Pressure gauges (2-1/8 inch diameter). Flat lens. 9.748 -0.15 ..... **\$565.00 EA** ⚠



**VT01SLF** .....ALL  
 6 Gauge Set. 140 mph speedo with odometer (3-3/8 inch diameter), Tachometer (3-3/8 inch diameter). Separate Fuel, Temp, Volt & Oil Pressure gauges (2-1/8 inch diameter). 9.748 -0.15 ..... **\$687.00 SET** ⚠



**VT02SLF** .....ALL  
 2 Gauge Set. 3-3/8 inch Speedo & standard quad. Flat lens. 9.748 -0.15 ..... **\$529.50 EA** ⚠

**VT35SLF** .....ALL  
 2 Gauge Set. 3-3/8 inch Ultimate Speedometer (Speedo-Tach combo) & quad cluster. Flat lens. 9.748 -0.15 ..... **\$725.00 SET** ⚠



**VT50SLF** .....ALL  
 Speedo-Tach combo. Flat lens. 9.748 -0.15 ..... **\$618.00 EA** ⚠



**VT52SLF** .....ALL  
 2 Gauge Set. 5 inch speedo & quad. Flat lens. 9.748 -0.15 ..... **\$632.00 SET** ⚠

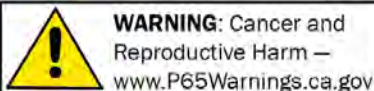

NOTE: Any chemicals will be shipped domestic ground only (Lower 48 states only). No international shipping.

**Instrument Gauges -Vintage Series, cont.**



**VT62SLF**.....ALL  
2 Gauge Set. 5 inch SpeedTachular & quad cluster. Flat lens. 9.748 -0.15  
..... **\$857.00 EA** ⚠



**VT80SLC**.....ALL  
Tach 8000rpm. Curved lens. 9.748 -0.15  
..... **\$157.00 EA** ⚠

**VT80SLF**.....ALL  
Tach 8000rpm. Flat lens. 9.748 -0.15  
..... **\$151.25 EA** ⚠



**VT93SLF**.....ALL  
Clock w/ reset button. Flat lens (3-3/8" dia.). 9.748 -0.15  
..... **\$153.00 EA** ⚠

**Instrument Gauges -Silver Series**



**BN00SLC**.....ALL  
5 Gauge Set. 140 mph speedo with odometer (3-3/8inch diameter). Separate Fuel, Temp, Volt & Oil Pressure gauges (2-1/8 inch diameter). Curved lens. 9.748 -0.15  
..... **\$588.00 EA** ⚠



**BN90SLF**.....ALL  
Clock w/ reset button. Flat lens. 2-1/8" dia. 9.748 -0.15  
..... **\$123.75 EA** ⚠

**Instrument Gauges Silver Grey Series**



**SG00SLF**.....ALL  
5 Gauge Set. 140 mph speedo with odometer (3-3/8inch diameter). Separate Fuel, Temp, Volt & Oil Pressure gauges (2-1/8 inch diameter). Flat lens. 9.748 -0.15  
..... **\$565.00 EA** ⚠



**SG01SLF**.....ALL  
6 Gauge Set. 140 mph speedo with odometer (3-3/8 inch diameter), Tachometer (3-3/8 inch diameter). Separate Fuel, Temp, Volt & Oil Pressure gauges (2-1/8 inch diameter). 9.748 -0.15  
..... **\$687.00 SET** ⚠



**SG02SLF**.....ALL  
2 Gauge Set. 3-3/8 inch Speedo & standard quad. Flat lens. 9.748 -0.15  
..... **\$531.00 EA** ⚠



**SG20SLF**.....ALL  
3-3/8" Speedo-Tach combo. Flat lens. 9.748 -0.15  
..... **\$340.00 EA** ⚠

**SG35SLF**.....ALL  
2 Gauge Set. 3-3/8 inch Ultimate Speedometer (Speedo-Tach combo) & quad cluster. Flat lens. 9.748 -0.15  
..... **\$725.00 SET** ⚠



**SG50SLF**.....ALL  
Speedo-Tach combo. Flat lens. 9.748 -0.15  
..... **\$618.00 EA** ⚠

**Instrument Gauges Silver Grey Series, cont.**



**SG52SLC**.....ALL  
2 Gauge Set. 5 inch speedo & quad. Curved lens. 9.748 -0.15  
..... **\$644.00 EA** ⚠



**SG62SLC**.....ALL  
2 Gauge Set. 5 inch SpeedTachular & quad cluster. Curved lens. 9.748 -0.15  
..... **\$869.00 EA** ⚠

**Instrument Gauges -Classic White Series**



**CW00SLF**.....ALL  
5 Gauge Set. 140 mph speedo with odometer (3-3/8inch diameter). Separate Fuel, Temp, Volt & Oil Pressure gauges (2-1/8 inch diameter). Flat lens. 9.748 -0.15  
..... **\$565.00 SET** ⚠



**CW01SLF**.....ALL  
6 Gauge Set. 140 mph speedo with odometer (3-3/8 inch diameter), Tachometer (3-3/8 inch diameter). Separate Fuel, Temp, Volt & Oil Pressure gauges (2-1/8 inch diameter). 9.748 -0.15  
..... **\$687.00 SET** ⚠

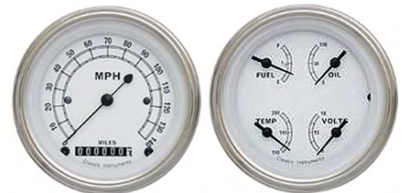

**CW02SLC**.....ALL  
2 Gauge Set. 3-3/8 inch Speedo & standard quad-cluster. Curved lens. 9.748 -0.15  
..... **\$543.00 EA** ⚠

**Instrument Gauges -Classic White Series, cont.**

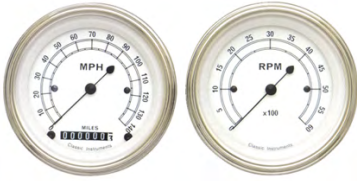

**CW02SLF** .....ALL  
2 Gauge Set. 3-3/8 inch Speedo & standard quad. Flat lens. 9.748 -0.15  
..... **\$531.00 SET** ⚠



**CW20SLF** .....ALL  
3-3/8" Speedo-Tach combo. Flat lens. 9.748 -0.15  
..... **\$340.00 EA** ⚠



**CW32SLF** .....ALL  
2 Gauge Set. 3-3/8 inch Ultimate Speedometer (Speedo-Tach combo) & quad cluster. Flat lens. 9.748 -0.15  
..... **\$678.00 SET** ⚠



**CW50SLF** .....ALL  
Speedo-Tach combo. Flat lens. 9.748 -0.15  
..... **\$618.00 EA** ⚠



**CW52SLF** .....ALL  
2 Gauge Set. 5 inch speedo & quad. Flat lens. 9.748 -0.15  
..... **\$632.00 SET** ⚠

**Instrument Gauges -Classic White Series, cont.**



**CW62SLF** .....ALL  
2 Gauge Set. 5 inch SpeedTachular & quad cluster. Flat lens. 9.748 -0.15  
..... **\$857.00 EA** ⚠



**CW80SLC** .....ALL  
Tach 8000rpm. Curved lens. 9.748 -0.15  
..... **\$157.00 EA** ⚠



**CW80SLF** .....ALL  
Tach 8000rpm. Flat lens. 9.748 -0.15  
..... **\$151.00 EA** ⚠



**CW90SLF** .....ALL  
Clock with reset button flat lens. 2-1/8" 0.000 -0.15  
..... **\$124.00 EA** ⚠



**CW93SLF** .....ALL  
Clock w/ reset button. Flat lens (3-3/8" dia.). 9.748 -0.15  
..... **\$153.00 EA** ⚠

**Instrument Gauges -White Hot Series**



**WH01SLF** .....ALL  
6 Gauge Set. 140 mph speedo with odometer (3-3/8 inch diameter), Tachometer (3-3/8 inch diameter). Separate Fuel, Temp, Volt & Oil Pressure gauges (2-1/8 inch diameter). 9.748 -0.15  
..... **\$687.00 SET** ⚠



**WH02SLC** .....ALL  
2 Gauge Set. 3-3/8 inch Speedo & standard quad-cluster. Curved lens. 9.748 -0.15  
..... **\$543.00 EA** ⚠

**WH35SLF** .....ALL  
2 Gauge Set. 3-3/8 inch Ultimate Speedometer (Speedo-Tach combo) & quad cluster. Flat lens. 9.748 -0.15  
..... **\$725.00 SET** ⚠



**WH52SLC** .....ALL  
2 Gauge Set. 5 inch speedo & quad. Curved lens. 9.748 -0.15  
..... **\$644.00 EA** ⚠

**WH80SLC** .....ALL  
Tach 8000rpm. Curved lens. 9.748 -0.15  
..... **\$157.00 EA** ⚠



**WH90SLF** .....ALL  
New Classic Instruments clock 2-1/8" with reset button - white got series 0.000 -0.15  
..... **\$124.00 EA** ⚠

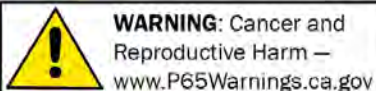

NOTE: Any chemicals will be shipped domestic ground only (Lower 48 states only). No international shipping.

**Instrument Gauges -White Hot Series, cont.**



**WH93SLC**.....ALL  
Clock w/ reset button. Curved lens (3-3/8" dia.). 9.748 -0.15 ..... **\$159.00 EA** ⚠



**WH93SLF**.....ALL  
Clock w/ reset button. Flat lens (3-3/8" dia.). 9.748 -0.15 ..... **\$152.75 EA** ⚠

**Instrument Gauges -Black Face**

Our ALPHA-OMEGA gauges offer monitoring of your vitals at an unbeatable price. Sets include needed senders. Pulse generator may be required for some electronic gauge applications.

These black face ALPHA-OMEGA gauges feature red pointers with white indicators and stainless bezels.



**CLOCKBLK**.....ALL  
2-1/16" Clock. Stainless bezel with white hands. 9.748 -0 ..... **\$75.25 EA** ⚠



**QUAD338BLACKM**.....ALL  
3-3/8" dual gauge set. Mechanical speedo. Silver bezels, red pointers. -0.15 ..... **\$298.50 SET** ⚠

**Instrument Gauges -Black Face, cont.**



**QUAD338BLACKPRO**.....ALL  
3-3/8" dual gauge set. Electronic, programmable speedo. Stainless bezels, red pointers. 9.748 -0.15 ..... **\$360.00 EA** ⚠

**QUAD5BLACKPRO** .ALL  
2 Gauge Set. 5". Electronic, programmable speedo. Stainless bezels, red pointers. 9.748 -0.15 ..... **\$400.39 EA** ⚠



**TACH338B**.....ALL  
3-3/8" Tach. 9.748 -0.15 ..... **\$110.50 EA** ⚠

**Instrument Gauges -Tan Face**

These tan face ALPHA-OMEGA gauges feature black pointers, black indicators and stainless bezels.



**CLOCKSB**.....ALL  
2-1/16" Clock. Stainless bezel with black hands. 9.748 -0 ..... **CALL** ⚠



**QUAD338SBM**.....ALL  
3-3/8" dual gauge set. Mechanical speedo. Stainless bezels, black pointers. 9.748 -0.15 ..... **\$290.00 SET** ⚠

**Instrument Gauges -Tan Face, cont.**



**QUAD338SBPRO**.....ALL  
3-3/8" dual gauge set. Electronic, programmable speedo. Silver bezels, black pointers. 9.748 -0.15 ..... **\$359.49 EA** ⚠



**QUAD5SBPRO**.....ALL  
2 Gauge Set. 5". Electronic, programmable speedo. Silver bezels, black pointers. 9.748 -0.15 ..... **\$397.75 EA** ⚠



**TACH5SB**.....ALL  
5" Tach. Silver bezel, black pointer. 9.748 -0.15 ..... **\$149.99 EA** ⚠



**TAN5M**.....ALL  
5 gauge set w/ mechanical speedo. -0 ..... **CALL** ⚠



**TAN5PRO**.....ALL  
5 gauge set w/ electronic speedo. -0.15 ..... **\$330.50 SET** ⚠

**Instrument Gauges -White Face**

These white face gauges feature red pointer, black indicators and stainless bezels.



**CLOCKWHITE** .....ALL  
2-1/16" Clock. Stainless bezel with black hands. 9.748 -0 ..... **\$75.25 EA** ⚠



**QUAD338WHITEM** .....ALL  
3-3/8" dual gauge set. Mechanical speedo. Silver bezels, red pointers. 9.748 -0.15 ..... **\$260.00 SET** ⚠



**QUAD338WHITEPRO** .....ALL  
3-3/8" dual gauge set. Electronic, programmable speedo. Stainless bezels, red pointers. 9.748 -0.15 ..... **\$359.49 EA** ⚠



**QUAD5WHITEPRO** .....ALL  
2 Gauge Set. 5". Electronic, programmable speedo. Stainless bezels, red pointers. 9.748 -0.15 ..... **\$397.79 EA** ⚠



**TACH338WHITE** .....ALL  
3-3/8" Tach. 8,000rpm with white face, red needle. 9.748 -0.15 ..... **\$109.99 EA** ⚠

**Instrument Gauges -White Face, cont.**



**TACH5WHITE** .....ALL  
5" Tach. White face, red needle. 9.748 -0.15 ..... **\$149.99 EA** ⚠



**WHITE5M** .....ALL  
5 gauge set. Mechanical speedo. Stainless bezels, red pointers. 9.748 -0.15 ..... **\$241.79 EA** ⚠



**WHITE5PRO** .....ALL  
5 gauge set. Electronic, programmable speedo. Stainless bezels, red pointers. 9.748 -0.15 ..... **\$295.00 EA** ⚠

**WHITE5PROM** .....ALL  
Metric 5 gauge set. Electronic, programmable speedo. Stainless bezels, red pointers. 9.748 -0.15 ..... **\$359.49 EA** ⚠

**Wire Harness - Instrument Gauges**



**DOC7706** .....ALL  
Universal harness for 5 or 6 gauge sets. Use with threaded stud gauges. 36" length. Includes 9 pin and other connectors. -0.15 ..... **\$90.00 EA** ⚠

**Pulse Generator - Auto Meter**



**AUM5291** .....ALL  
GM & most Chrysler transmissions. (for Auto Meter gauges only) -0.15 ..... **\$121.50 EA** ⚠



**AUM5292** .....ALL  
Ford transmissions (for Auto Meter gauges only) -0.15 ..... **\$112.00 EA** ⚠

**GPS Speed Sensors**

**DOC2-GPS** .....ALL  
GPS pulse generator for electronic speedo -0.15 ..... **\$138.79 EA** ⚠



**SN81-S** .....ALL  
The new Sky Drive™ will control your electronic speedometer using GPS satellites! It will quickly turn your speedometer into the world's most accurate speedometer possible by updating 10 times per second! With the ease of a one-time-setup that can be done in your garage, no driving needed. Calibrating with transmission signals, pulse generators, dip switches, and signal converters are not necessary. Can be mounted in any location or direction. Wiring harness and instructions for installation included. -0 ..... **\$250.00 EA** ⚠

**Dash Panel -Chevy Car**

These polished billet aluminum panels are designed to fit stock dashes. Fits Classic, Dolphin, and other instruments (gauges not included). For other gauge brands call or email and we can probably get a panel made to fit your application.



**ALUMDASH** .....37-38  
Billet aluminum polished - 5 gauge. Fits most gauges. Specify when ordering.. Gauges not included. 10.230 -0.15 ..... **\$102.00 EA** ⚠



**ALUMDASHT** .....37-38  
Billet aluminum polished for three 3-3/8in gauges. Fits most gauges. Specify when ordering.. Gauges not included. 10.230 -0.15 ..... **\$102.00 EA** ⚠

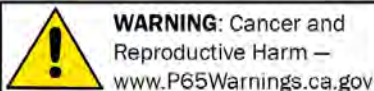

NOTE: Any chemicals will be shipped domestic ground only (Lower 48 states only). No international shipping.



**Dash Panel -Chevy Car, cont.**



**ALUMDASH** ..... 39  
 Billet aluminum polished - 5 gauge. Fits most gauges. Specify when ordering.. Gauges not included. 10.230 -0.15  
 ..... **\$114.79 EA** ⚠️



**ALUMDASHT** ..... 39  
 Billet aluminum, polished for three 3-3/8in. gauges. Fits most gauges. Specify when ordering.. Gauges not included. 10.230 -0.15  
 ..... **\$117.79 EA** ⚠️



**ALUMDASH** ..... 40  
 Billet aluminum polished - 5 gauge. Fits most gauges. Specify when ordering.. Gauges not included. 10.230 -0.15  
 ..... **\$155.50 EA** ⚠️



**ALUMDASHQ** ..... 40  
 Billet aluminum polished for two 3-3/8in gauges. Fits most gauges. Specify when ordering.. Gauges not included. 10.230 -0.15  
 ..... **\$155.00 EA** ⚠️



**210241** ..... 41-48  
 Blank panel to cover up holes and to match gauge inserts 2.192 -0  
 ..... **CALL** ⚠️

**Dash Panel -Chevy Car, cont.**



**210341** ..... 41-48  
 Under dash panel for ignition and misc. switches and power points 2.192 -0  
 ..... **CALL** ⚠️



**ALUMDASH** ..... 41-48  
 Billet aluminum polished - 5 gauge. Fits most gauges. Specify when ordering.. Gauges not included. 10.230 -0.15  
 ..... **\$164.00 EA** ⚠️



**ALUMDASH5** ..... 41-48  
 Billet aluminum polished - 5 gauge. 4 2-1/16 and 5 inch speedo. Gauges not included. 10.230 -0.15  
 ..... **\$157.75 EA** ⚠️



**ALUMDASHT** ... 41-48  
 Billet aluminum polished tach adapter fits 3-3/8in tach. 10.230 -0.15  
 ..... **\$77.00 EA** ⚠️



**ALUMDASHT5** ..... 41-48  
 Tach adaptor for 41-48 dash. 5 inch tach. 10.230 -0.15  
 ..... **\$77.00 EA** ⚠️



**ALUMDASH** ..... 49-50  
 Billet aluminum polished - 5 gauge. Fits most gauges. Specify when ordering.. Gauges not included. 10.230 -0.15  
 ..... **\$127.50 EA** ⚠️

**Dash Panel -Chevy Car, cont.**



**ALUMDASH** ..... 51-52  
 Billet aluminum polished for two 3-3/8in gauges. Fits most gauges. Specify when ordering.. Gauges not included. 10.230 -0.15  
 ..... **\$133.59 EA** ⚠️



**ALUMDASH5** ..... 51-52  
 Billet aluminum polished for two 5 inch gauges. Gauges not included. 10.230 -0.15  
 ..... **\$168.00 EA** ⚠️



**ALUMDASHC** ... 51-52  
 Billet aluminum polished with clock adapter fits 2-1/16in clock, fits Classic and Dolphin instruments. 10.230 -0.15  
 ..... **\$84.75 EA** ⚠️



**ALUMDASH** ..... 53-54  
 Billet aluminum polished - 5 gauge. Fits most gauges. Specify when ordering.. Gauges not included. 10.230 -0.15  
 ..... **\$101.99 EA** ⚠️

**ALUMDASH5** ..... 53-54  
 Billet aluminum polished - 5 gauge. Fits most gauges. Specify when ordering Gauges not included. For 5" Speedo 10.230 -0.15  
 ..... **\$205.69 EA** ⚠️

**Dash Panel -Chevy Truck**



**ALUMDASH** ..... 37  
 Billet aluminum polished for five gauges. Fits most gauges. Specify when ordering.. Gauges not included. 10.230 -0.15  
 ..... **\$134.99 EA** ⚠️

**Dash Panel -Chevy Truck, cont.**



**ALUMDASH.....40-46**  
Billet aluminum polished for five gauges. Fits most gauges. Specify when ordering.. Gauges not included. 10.230 -0.15  
..... **\$137.50 EA** ⚠️



**ALUMDASHQ.....40-46**  
Billet aluminum polished for two 3-3/8in gauges. Fits most gauges. Specify when ordering.. Gauges not included. 10.230 -0.15  
..... **\$137.50 EA** ⚠️



**ALUMDASHT.....40-46**  
Billet aluminum polished for 3 gauges. Fits most gauges. Specify when ordering.. Gauges not included. 10.230 -0.15  
..... **\$125.00 EA** ⚠️



**ALUMDASH5.....47-53**  
Billet aluminum polished for two 5in gauges. Fits most gauges. Specify when ordering.. Gauges not included. 10.230 -0.15  
..... **\$102.00 EA** ⚠️



**BRKT.....47-53**  
Bracket kit to mount 5 inch speedo & quad. 9.748 -0.15  
..... **\$20.00 SET** ⚠️

**Dash Panel -Chevy Truck, cont.**

**ALUMDASH5.....54**  
Billet aluminum polished for two 5in gauges. Fits most gauges. Specify when ordering.. Gauges not included. 10.230 -0  
..... **\$109.75 EA** ⚠️

**Dash Panel -Ford Car**



**ALUMDASHF.....40**  
Billet aluminum polished 5 gauge. Fits most gauges. Specify when ordering.. Gauges not included. -0.15  
..... **\$180.00 EA** ⚠️



**ALUMDASHFC....40**  
Billet aluminum polished clock. Fits most gauges. Specify when ordering.. Gauges not included. -0.15  
..... **\$84.75 EA** ⚠️



**ALUMDASHFC..49-50**  
Billet aluminum polished, clock. Fits most gauges. Specify when ordering.. Gauges not included. -0.15  
..... **\$65.25 EA** ⚠️

**Dash Panel -Ford Truck**



**ALUMDASHF.....37-38**  
Billet aluminum polished 5 Gauge. Fits most gauges. Specify when ordering.. Gauges not included. -0.15  
..... **\$110.00 EA** ⚠️

**Dash Panel -Mercury Car**



**ALUMDASHM.....49**  
Billet aluminum polished 5 Gauge. Fits most gauges. Specify when ordering.. Gauges not included. -0.15  
..... **\$150.25 EA** ⚠️

**Dash Panel LED Lights**



**INDICATOR.....ALL**  
Indicators. 2 green, 1 red for turn signal and high beam LEDs. Fits billet aluminum dash panels or anywhere else you can think to install for lighting. Note: 0.166" hole size 10.230 -0



**INDICATORB.....ALL**  
Indicators. 2 green, 1 blue for turn signal and high beam LEDs. Fits billet aluminum dash panels or anywhere else you can think to install for lighting. Note: 0.166" hole size 10.230 -0.15



**WASL18B1-4.....ALL**  
Blue. 1/4" dia. Use for turn, high beam or power indicators. 12 vdc. -0.15  
..... **\$9.99 EA** ⚠️

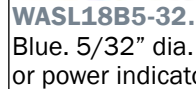

**WASL18B5-32.....ALL**  
Blue. 5/32" dia. Use for turn, high beam or power indicators. 12 V. -0.15  
..... **\$9.99 EA** ⚠️

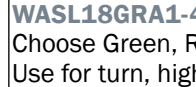

**WASL18GRA1-4.....ALL**  
Choose Green, Red or Amber.1/4" dia. Use for turn, high beam or power indicators. 12 vdc. -0.15  
..... **\$6.00 EA** ⚠️

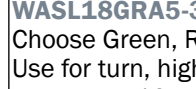

**WASL18GRA5-32.....ALL**  
Choose Green, Red or Amber.5/32" dia. Use for turn, high beam or power indicators. 12 V. -0.15  
..... **\$4.00 EA** ⚠️

**Chrome Bezel LED Lights**



**WASL66GRA.....ALL**  
Attractive chrome bezel is approx. 9/16" dia. by 7/32" high when installed. Mount in 7/16" dia. hole. 12 vdc. with grounding terminal. Interior use only. Choose Green, Red, Amber or Blue. -0.15  
..... **\$10.00 EA** ⚠️

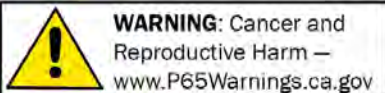

**WARNING: Cancer and Reproductive Harm** —  
www.P65Warnings.ca.gov

NOTE: Any chemicals will be shipped domestic ground only (Lower 48 states only). No international shipping.

**Glove Box Modified for A/C - Chevy Cars**



**4073755AIR** ..... 37  
Cars with A/C. Cloth lined w/ clips.  
10.260 -0.15 ..... **\$34.75 EA** ⚠

**4081940AIR**..... 38  
Cars with A/C.  
Cloth lined w/ clips.  
10.260 -0.15 ..... **\$34.75 EA** ⚠

**4089940AIR**..... 39  
Cars with A/C.  
Cloth lined w/ clips.  
10.260 -0.15 ..... **\$34.75 EA** ⚠

**Glove Box Modified for A/C - Chevy Trucks**



**367645AIR**.....47-49  
Trucks with A/C,  
moulded from ABS  
16.100 -0  
..... **\$116.00 EA** ⚠

**Ash Tray Insert Chevy Cars**



**216541**.....41-48  
Insert for existing ash tray with two 12 volt  
power ports installed 12.045 -0 **CALL** ⚠

**Cup Holders**



**4754CH2** .....47-54  
This cup holder is a direct bolt in for your  
classic Chevy pickup. No drilling required.  
Laser cut from 16 gauge stainless steel  
with aluminum cups. -0 .. **\$50.00 EA** ⚠



**4754CH3** .....47-54  
This cup holder is a direct bolt in for your  
classic Chevy pickup. No drilling required.  
Laser cut from 16 gauge stainless steel  
with aluminum cups.-0 .. **\$55.00 EA** ⚠

**Cup Holders, cont.**



**6066CH2** .....60-66  
This cup holder is a direct bolt in for your  
classic Chevy pickup. No drilling required.  
Laser cut from 16 gauge stainless steel  
with aluminum cups. -0 .. **\$50.00 EA** ⚠



**6066CH3** .....60-66  
This cup holder is a direct bolt in for your  
classic Chevy pickup. No drilling required.  
Laser cut from 16 gauge stainless steel  
with aluminum cups. -0 .. **\$55.00 EA** ⚠



**CUPHOLDO**.....ALL  
Polished, oval billet aluminum face.  
Sliding, hidden single cup. 6 5-8in. wide x  
3-4in. high x 6in. deep. 10.185 -0.15  
..... **\$148.69 EA** ⚠



**CUPHOLDS** .....ALL  
Polished, oval billet aluminum face.  
Sliding, hidden single cup. 6 5-8in. wide x  
3-4in. high x 6in. deep. 10.185 -0.15  
..... **\$148.75 EA** ⚠



**WASB-DH** .....ALL  
Magnetic base allows you to use when  
needed, hide when not. 3" I.D., 2-1/2"  
deep. Includes plastic inner cup to hold  
condensation. Dual black o-rings for  
added grip and looks. -0.15  
..... **\$39.00 EA** ⚠

**Push Button Ignition Switch**



**WASL75** .....ALL  
Chrome recessed switch with LED ring.  
Ignition, Start & Stop. Push button and  
hold for start and LED lights up. Push  
again to stop engine. Choose Green, Red  
or Amber. 3/4" dia. -0.15  
..... **\$199.25 EA** ⚠



**WASL75B** .....ALL  
Black recessed switch with LED ring.  
Ignition, Start & Stop. Push button and  
hold for start and LED lights up. Push  
again to stop engine. Choose Green, Red  
or Amber. 3/4" dia. -0.15  
..... **\$199.00 EA** ⚠

**Dash Knobs**

Polished machined aluminum dash knobs  
available in 2 lengths and 2 hole sizes.



**R8400POL** .....ALL  
Polished machined aluminum dash knob  
- 3/16" hole. -0.15 ..... **\$4.00 EA** ⚠



**R8401POL** .....ALL  
Polished machined aluminum dash knob  
- 1/4" hole. -0.15 ..... **\$4.00 EA** ⚠



**R8402** .....ALL  
Polished machined  
aluminum dash knob -  
3/16" hole. -0.15  
..... **\$3.25 EA** ⚠

**Dash Knobs, cont.**



**R8403**.....ALL  
Polished machined aluminum dash knob  
- 1/4" hole. -0.15 ..... **\$3.25 EA** ⚠



**R8404**.....ALL  
Polished machined aluminum dash knob  
- 3/16" hole. -0.15 ..... **\$3.25 EA** ⚠

**Dash Knobs (Paul Atkins Signature Series)**



**CMW-DK802**.....ALL  
Smooth. Chrome, 7/8" dia., 3/16" I.D. shaft hole. -0.15 ..... **\$16.00 EA** ⚠



**CMW-DK803**.....ALL  
Grooved. Chrome, 7/8" dia., 3/16" I.D. shaft hole. -0.15 ..... **\$15.59 EA** ⚠

**Automatic Headlight Switch**



**PAC-1300**.....ALL  
Control your headlights, interior lights and accessory power like current day vehicles. Headlights automatically turn on in low light levels and off with increased light. You can program headlight shutoff time even after vehicle is shut off. Light your path after you leave the vehicle. Programmable control of dome lights for slow fade after door is opened or ignition shut off and use of electric powered accessories after ignition is shut off for programmed duration of up to 20 minutes. Also comes with a unique power regulator to shut off lights & accessories to retain battery power prior to over usage so vehicle may be started. -0.15 ..... **\$200.00 EA** ⚠

**Voltage Reducer**



2.500 -0.15

**1119004**.....ALL  
Reducer 12v to 6v. Best for fuel gauge. Hi-Tech w/ constant volts.

..... **\$19.00 EA** ⚠



2.500 -0.15

**1119004A**.....ALL  
12v conversion. 1 per gauge Hi-Tech w/ voltage not constant.

..... **\$4.50 EA** ⚠



2.500 -0.15

**1119005**.....ALL  
12v to 6v voltage reducer to operate heater, radio & gauges. Hi-tech, delivers constant volts. Superior quality.

..... **\$93.25 EA** ⚠



2.500 -0.15

**1119005C**.....ALL  
12v to 6v voltage reducer to operate heater.

..... **\$19.75 EA** ⚠



2.500 -0.4

**1506373A**.....ALL  
12v to 6v. Up to 4 amp draw affects voltage.

..... **\$8.50 EA** ⚠

**Voltage Booster**



**1119007**.....ALL  
6v to 12v high current booster (3.7-5.0 amps) great for: radar detectors, CB radios, mobile phones, modern stereo radios w/ CD & tape and alarm systems (control only). 2.500-0.15 .. **\$105.25 EA** ⚠

**Modern Replica Radios - Chevy Car**

Small size, big features! Original looking unit with current day audio technology. Fits stock dash radio opening without modifications. Shallow 2-1/2 inch case depth allows room for dash components such as electric wipers, air conditioning, etc.



**986517R**.....51-52  
Radio, no speakers  
9.650 -0.15 ..... **\$631.00 EA** ⚠



**986517S**.....51-52  
Radio w/ speakers  
9.650 -0.15 ..... **\$746.25 EA** ⚠



**986670R**.....53-54  
Radio no speakers 9.650 -0.15 ..... **\$632.50 EA** ⚠



**986670S**.....53-54  
Radio w/ speakers 9.650 -0.15 ..... **\$748.00 EA** ⚠



**ARCHEV552**.....55  
Chevy Car AM/FM/  
Stereo Radio Only -0.15

..... **\$632.50 EA** ⚠



**WARNING:** Cancer and Reproductive Harm — www.P65Warnings.ca.gov

NOTE: Any chemicals will be shipped domestic ground only (Lower 48 states only). No international shipping.

**(800) 952-1752 • www.streetrodhq.com**

**Modern Replica Radios - Chevy Car, cont.**

 **ARCHEV553** ..... 55  
Chevy Car Wonderbar  
AM/FM/Stereo Radio

Only -0.15  
..... **\$803.00 EA** ⚠

 **ARCHEV561** ..... 56  
Chevy Car Push Button  
AM/FM/Stereo Radio

Only -0.15  
..... **\$632.50 EA** ⚠

 **ARCHEV562** ..... 56  
Chevy Wonderbar  
AM/FM/Stereo Radio

Only -0.15  
..... **\$803.00 EA** ⚠

 **ARCHEV563** ..... 56-57  
Chevy Corvette AM/FM/  
Stereo Radio Only -0.15

..... **\$803.00 EA** ⚠

 **ARCHEV571** ..... 57  
Chevy Car Wonderbar  
AM/FM/Stereo Radio

Only -0.15  
..... **\$748.00 EA** ⚠

 **ARCHEV581** ..... 58  
Chevy Car Wonderbar  
AM/FM/Stereo Radio

Only -0.15  
..... **\$748.00 EA** ⚠

 **ARCHEV582** ..... 58  
Chevy Corvette  
Wonderbar AM/FM/  
Stereo Radio Only -0.15

..... **\$748.00 EA** ⚠

 **ARCHEV591** ..... 59-60  
Chevy Car Wonderbar  
AM/FM/Stereo Radio

Only -0.15  
..... **\$748.00 EA** ⚠

 **ARCHEV592** ..... 59-60  
Chevy Corvette  
Wonderbar AM/FM/  
Stereo Radio Only -0.15

..... **\$748.00 EA** ⚠

 **ARCHEV611** ..... 61-62  
Chevy Car AM/FM/  
Stereo Radio Only -0.15

..... **\$632.50 EA** ⚠

 **ARCHEV612** ..... 61-62  
Chevy Corvette  
Wonderbar AM/FM/  
Stereo Radio Only -0.15

..... **\$748.00 EA** ⚠

 **ARCHEV631** ..... 63  
Chevy Car AM/FM/  
Stereo Radio Only -0.15

..... **\$687.50 EA** ⚠

**Modern Replica Radios - Chevy Car, cont.**

 **ARCHEV632** ..... 63-64  
Chevy Corvette AM/FM/  
Stereo Radio Only -0.15

..... **\$687.50 EA** ⚠

 **ARCHEV641** ..... 64  
Chevy Car AM/FM/  
Stereo Radio Only -0.15

..... **\$687.50 EA** ⚠

**Modern Replica Radios - Chevy Truck**



**986444R** ..... 47-53  
Radio without speaker 9.650 -0.15

..... **\$631.00 EA** ⚠



**986444S** ..... 47-53  
Radio with speakers. Pair of 4in x 6in  
mounted to new radio. 9.650 -0.15

..... **\$746.25 SET** ⚠



**986771R** ..... 54-55  
Radio with out speakers 9.650 -0.15

..... **\$576.00 EA** ⚠



**986771S** ..... 54-55  
Radio with speakers. Pair of 4in x 6in  
mounted to new radio (not sold  
separately). 9.650 -0.15

..... **\$691.25 SET** ⚠

**Modern Replica Radios - Chevy Truck, cont.**

 **ARCHEV551** ..... 55-59  
1955 2nd Series &  
1956-59 Chevy Truck  
AM/FM/Stereo Radio -0.15

..... **\$577.50 EA** ⚠

**Modern Replica Radios - GMC**



**986444RG** ..... 47-53  
GMC without speakers 9.650 -0.15

..... **\$632.50 EA** ⚠



**986771CG** ..... 54  
GMC without speakers 9.650 -0.15

..... **\$576.00 EA** ⚠

 **ARGMC551** ..... 55-59  
GMC Truck AM/FM/  
Stereo Radio Only -0.15

..... **\$577.50 EA** ⚠

**Modern Replica Radios - Ford Car**

 **ARFORD551** ..... 55  
Ford T-Bird AM/FM/  
Stereo Radio Only -0.15

..... **\$687.50 EA** ⚠

**ARFORD571** ..... 57  
Ford Car Radio AM/FM Stereo Fairlane,  
Custom, Ranchero & Station Wagon. Radio  
Only -0.15

..... **\$803.00 EA** ⚠

**ARFORD581** ..... 58  
Ford Car Radio AM/FM Stereo Fairlane,  
Custom, Ranchero & Station Wagon. Radio  
Only -0.15

..... **\$803.00 EA** ⚠

**ARFORD591** ..... 59  
Ford Car Radio AM/FM Stereo Custom,  
Fairlane, Galaxie, Ranchero, Station  
Wagons. Radio Only -0.15

..... **\$803.00 EA** ⚠

**ARFORD611** ..... 60-61  
Ford Car Radio AM/FM Stereo Galaxie  
Fairlane & Custom. Radio Only -0.15

..... **\$632.50 EA** ⚠

**ARFORD621** ..... 62  
Ford Car Radio AM/FM Stereo Galaxie.  
Radio Only -0.15

..... **\$632.50 EA** ⚠

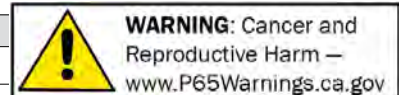

**Modern Replica Radios - Ford Car, cont.**



**ARFORD631..... 63**  
Ford Galaxie AM/FM/  
Stereo Radio Only -0.15

**\$687.50 EA** ⚠



**ARFORD632..... 63**  
Ford T-Bird AM/FM/  
Stereo Radio Only -0.15

**\$687.50 EA** ⚠



**ARFORD642..... 64**  
Ford Galaxie AM/FM/  
Stereo Radio Only -0.15

**\$687.50 EA** ⚠

**Bluetooth Adapter**



**BT01.....ALL**  
Bluetooth adapter for  
radios with an auxiliary  
input. -0.15

**\$40.00 EA** ⚠

**Bluetooth Speakers**



**WASITFD.....ALL**  
Bluetooth speaker fuzzy  
dice. Easy setup with  
built in microphone &  
stereo speakers makes  
hands free calling safe  
& easy.

Works with your smart phone for calling,  
music, navigation & more.  
Rechargeable long play battery. USB  
charging cord included. Great in the shop  
or at cruise nights too. -0.15

**\$109.00 EA** ⚠

**Antenna-Hidden**



**HAB.....ALL**  
FM reception without the ugly mast.  
Universal application. 9.645 -0.15

**\$47.00 EA** ⚠

**Antenna-Power**



**984995P.....ALL**  
Fully automatic. Fits on top of cowl or  
fender. 9.645 -0.15

**\$77.50 EA** ⚠

**Laser Jammer**

The HP-905 Compact sensors are super small,  
30% smaller (by volume) compared to the  
smallest competitive product on the market.  
The HP-905 is powered by extremely powerful  
laser diodes. This feature alone places the  
HP-905 in a class of its own. The new sensors  
fit easily and very discretely into the tightest of  
grille spacings and make mounting and vehicle  
body integration a breeze.

The new HP-905 sensors are many times more  
powerful than previous models, incorporating  
both high output laser diodes and high power  
LED's in one sensor. This hybrid combination  
eliminates the usual problem with laser diode  
"grid patterns" which are an unfortunate  
feature of single laser diode units. What this  
means to you is a "homogeneous beam" and  
a higher degree of vehicle "invisibility" to laser  
based speed guns.



**HP905CP.....ALL**  
Blinder M-47 xtreme laser jammer. Triple  
sensor. -0.15

**\$750.00 EA** ⚠

**HP905DUAL.....ALL**  
Blinder M-47 xtreme laser jammer. Dual  
sensor. -0.15

**\$600.00 EA** ⚠

**HP905QUAD.....ALL**  
Blinder M-47 xtreme laser jammer. Quad  
sensor. -0.15

**\$900.00 EA** ⚠

**M-47XTREME.....ALL**  
Blinder M-47 xtreme  
laser jammer. -0.15

**\$750.00 EA** ⚠

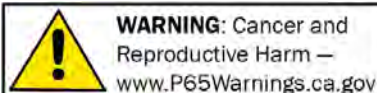

**WARNING: Cancer and  
Reproductive Harm —  
www.P65Warnings.ca.gov**

NOTE: Any chemicals will be shipped domestic ground only (Lower 48 states only). No international shipping.

**(800) 952-1752 • www.streetrodhq.com**

**Power Cowl Vent Kit**



**WASL34** .....ALL  
Give your cowl vent a lift with this powerful gear motor kit that comes complete with gear motor, brackets, hardware, interior switch, wire, connectors and instructions. Steel bracket for cowl can be bolted or welded. Attractive 5" aluminum rod arm gives a clean look. Motor with mounting bracket and lever arm measure 2-1/2" wide, 4" high and 3-1/4" deep including motor, not including 5" connecting arm. Also works for power glove box door. Not waterproof. -0.15 ..... **\$109.25 SET** ⚠

**Cowl Vent Filler Panel -Chevy Trucks**



**3683004A53** .....47-53  
Weld in panel to delete vent. 16.545 -0.15 ..... **\$24.00 EA** ⚠



**4754CF** .....47-54  
Upper Cowl Filler finishes off your clean firewall look when paired with our Firewall Filler Panels. The piece is laser cut from 18 gauge steel and easily installed in the original recess. 1.000 -0 ..... **\$40.00 EA** ⚠



**3683004B54** ..... 54  
Weld in panel to delete vent. 16.545 -0.3 ..... **\$18.00 EA** ⚠



**6066CF** .....60-66  
This Upper Cowl Filler finishes off your clean firewall look when paired with our firewall fillers. The piece is laser cut from from 18 gauge steel and easily installed in the original recess. -0 ..... **\$30.00 EA** ⚠

**Header Panel Chevy Trucks**



**593369** .....36-38  
Mounts above windshield (fiberglass). 16.562 -0.15 ..... **\$129.00 EA** ⚠



**598772** .....39-46  
Mounts above windshield (fiberglass). 16.563 -0.15 ..... **\$129.00 EA** ⚠

**Wiper Motor Access Hole Covers For Chevy Trucks**



**593351L** .....36-38  
Left (fiberglass). 16.563 -0 ..... **\$19.00 EA** ⚠



**593352R** .....36-38  
Right (fiberglass). 16.563 -0 ..... **\$19.00 EA** ⚠

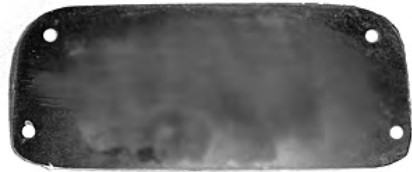

**593353** .....36-38  
Blank cover for the right side wiper access hole made of fiberglass. 16.563 -0.15 ..... **\$17.00 EA** ⚠

**Wiper Motor Access Hole Covers For Chevy Trucks, cont.**



**598811L** .....39-46  
Left (fiberglass). 16.563 -0 ..... **\$19.00 EA** ⚠



**598813R** .....39-46  
Right (fiberglass). 16.563 -0 ..... **\$19.00 EA** ⚠



**598814** .....39-46  
Blank (fiberglass). 16.563 -0.15 ..... **\$18.00 EA** ⚠

**Voltage Booster**



**NE14206** .....ALL  
Voltage Booster 6 to 12 volts. Works with positive or negative ground. -0.15 ..... **\$173.00 EA** ⚠

**Electric Wiper Conversion Kits**

These kits replaces motor and 2 transmissions. Motor and quiet cable drive can be mounted outside passenger compartment for smooth, noise free operation. When ordering these conversion kits, you need arms & blades. 3683910 RL/RR/S also need 4103740 for '37-39 and '40-48.

**598988F** .....37-46  
Chevy Truck Intermittent-replaces motor & 2 transmissions. Quiet cable drive & motor can be mounted outside passenger compartment for quiet operation. 16.064 -0.15 ..... **\$310.00 KIT** ⚠

**Electric Wiper Conversion Kits, cont.**



**4132637F** ..... **37-57**  
 Universal 12 volt kit with intermittent wiper relay switch. All parts as included in kit #4132637E. 10.150 -0.15  
 ..... **\$310.00 KIT** ⚠



**4089934E** ..... **47-54**  
 Chevy Truck, Replaces motor & 2 transmissions. Quiet cable drive & motor can be mounted outside passenger compartment for quiet operation.  
 16.064 -0.15 ..... **\$337.00 KIT** ⚠  
**4089934F** ..... **47-54**  
 Chevy Truck Intermittent-replaces motor & 2 transmissions. Quiet cable drive & motor can be mounted outside passenger compartment for quiet operation.  
 16.064 -0.15 ..... **\$373.00 KIT** ⚠



**4132637E** ..... **ALL**  
 Universal 12 volt kit. Replaces motor & 2 transmissions. Motor and quiet cable drive can be mounted outside passenger compartment for smooth, noise free operation. 10.150 -0 ..... **\$300.00 KIT** ⚠

**Electric Wiper Motor Buick**

The Clean Wipe Wiper Drive is a true bolt-in replacement for your original equipment vacuum or electric windshield wiper motor. Each model of the Clean Wipe Wiper Drive is designed for the specific year and model of vehicle. Wiper drives attach to the stock mounting brackets. Designed for attachment to O.E.M. wiper transmission or cable drums. Our kits are 12 volt. If your vehicle is 6 volt, you will need a power inverter (NE14206). Each kit comes complete with nylon bushings to replace the rubber grommets in the wiper transmission linkage arms. (when required)

**Electric Wiper Motor Buick**



**EWBUICK37** ..... **37-38**  
 Buick Passenger Car Electric Wiper Motor 12 Volt -0.15  
 ..... **\$230.00 EA** ⚠

**EWBUICK391** ..... **39**  
 Buick Passenger Car Electric Wiper Motor 12 Volt -0.15  
 ..... **\$230.00 EA** ⚠

**EWBUICK392** ..... **39**  
 Buick Passenger Car Electric Wiper Motor 12 Volt Does Not Clear Stock Radio, Stock Motor Located Near Steering Column -0.15  
 ..... **\$230.00 EA** ⚠

**EWBUICK401** ..... **40**  
 Buick Passenger Car Electric Wiper Motor 12 Volt -0.15  
 ..... **\$230.00 EA** ⚠

**EWBUICK402** ..... **40**  
 Buick Passenger Car Electric Wiper Motor 12 Volt -0.15  
 ..... **\$230.00 EA** ⚠

**EWBUICK41** ..... **41**  
 Buick Passenger Car Electric Wiper Motor 12 Volt -0.15  
 ..... **\$230.00 EA** ⚠

**EWBUICK42** ..... **42-49**  
 Buick : Series 42A, 40-60, 50-70, 46S, 41 Electric Wiper Motor 12 Volt -0.15  
 ..... **\$230.00 EA** ⚠

**EWBUICK46** ..... **46-48**  
 Buick : Series 51, 56C, 56S, 59, 71, 76C, 76S, Cable Operated Electric Wiper Motor 12 Volt -0.15  
 ..... **\$230.00 EA** ⚠

**EWBUICK49** ..... **49**  
 1949 Buick : C Series, Model 59, Cable Operated Electric Wiper Motor 12 Volt -0.15  
 ..... **\$230.00 EA** ⚠

**Electric Wiper Motor Buick, cont.**

**EWBUICK50** ..... **50-54**  
 Buick Passenger Car Electric Wiper Motor 12 Volt -0.15  
 ..... **\$230.00 EA** ⚠

**EWBUICK51** ..... **51-53**  
 Buick Special Electric Wiper Motor 12 Volt -0.15  
 ..... **\$230.00 EA** ⚠

**EWBUICK551** ..... **55-56**  
 Buick (Special & Century) Electric Wiper Motor 12 Volt -0.15  
 ..... **\$230.00 EA** ⚠

**EWBUICK552** ..... **55-56**  
 Buick (Super & Roadmaster) Electric Wiper Motor 12 Volt -0.15  
 ..... **\$230.00 EA** ⚠

**EWBUICK57** ..... **57**  
 Buick Passenger Car Electric Wiper Motor 12 Volt -0.15  
 ..... **\$230.00 EA** ⚠

**EWBUICK58** ..... **58**  
 Buick Passenger Car Electric Wiper Motor 12 Volt -0.15  
 ..... **\$230.00 EA** ⚠

**Electric Wiper Motor Cadillac**

The Clean Wipe Wiper Drive is a true bolt-in replacement for your original equipment vacuum or electric windshield wiper motor. Each model of the Clean Wipe Wiper Drive is designed for the specific year and model of vehicle. Wiper drives attach to the stock mounting brackets. Designed for attachment to O.E.M. wiper transmission or cable drums. Our kits are 12 volt. If your vehicle is 6 volt, you will need a power inverter (NE14206). Each kit comes complete with nylon bushings to replace the rubber grommets in the wiper transmission linkage arms. (when required)



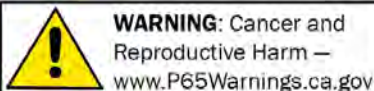

**EWCAD37** ..... **37**  
 Cadillac Passenger Car Electric Wiper Motor 12 Volt -0.15  
 ..... **\$230.00 EA** ⚠



NOTE: Any chemicals will be shipped domestic ground only (Lower 48 states only). No international shipping.



**Electric Wiper Motor Cadillac, cont.**

-  **EWCAD391**..... 39  
Cadillac (All Except 60 Special) Electric Wiper Motor 12 Volt -0.15  
..... **\$230.00 EA** ⚠
-  **EWCAD392**..... 39  
Cadillac (Series 60) Electric Wiper Motor 12 Volt -0.15  
..... **\$230.00 EA** ⚠
-  **EWCAD393**..... 39  
Cadillac (Series 61) Electric Wiper Motor 12 Volt -0.15  
..... **\$230.00 EA** ⚠
-  **EWCAD40**..... 40  
Cadillac Series 60, 61-72, 75-90 Electric Wiper Motor 12 Volt -0.15  
..... **\$230.00 EA** ⚠
-  **EWCAD41**..... 41  
Cadillac Series 61, 63, 67 Electric Wiper Motor 12 Volt -0.15  
..... **\$230.00 EA** ⚠
-  **EWCAD42**..... 42-48  
Cadillac Series 60, 62, 75c, 61 Uses Linkage Electric Wiper Motor 12 Volt -0.15  
..... **\$230.00 EA** ⚠
- EWCAD481**..... 48  
Cadillac Series 61, 62 Electric Wiper Motor 12 Volt -0.15  
..... **\$230.00 EA** ⚠
- EWCAD482**..... 48-49  
Cadillac Series 75 Cable Operated Electric Wiper Motor 12 Volt -0.15  
..... **\$230.00 EA** ⚠
- EWCAD49**..... 49  
Cadillac Series 60, 61, 62 Electric Wiper Motor 12 Volt -0.15  
..... **\$230.00 EA** ⚠
-  **EWCAD50**..... 50-53  
Cadillac Passenger Car Electric Wiper Motor 12 Volt -0.15  
..... **\$230.00 EA** ⚠
- EWCAD54**..... 54-58  
Cadillac Passenger Car Electric Wiper Motor 12 Volt -0.15  
..... **\$230.00 EA** ⚠
- EWCAD58**..... 58  
Cadillac Eldorado Brougham Electric Wiper Motor 12 Volt -0.15  
..... **\$230.00 EA** ⚠









**Electric Wiper Motor Chevy**

The Clean Wipe Wiper Drive is a true bolt-in replacement for your original equipment vacuum or electric windshield wiper motor. Each model of the Clean Wipe Wiper Drive is designed for the specific year and model of vehicle. Wiper drives attach to the stock mounting brackets. Designed for attachment to O.E.M. wiper transmission or cable drums. Our kits are 12 volt. If your vehicle is 6 volt, you will need a power inverter (NE14206). Each kit comes complete with nylon bushings to replace the rubber grommets in the wiper transmission linkage arms. (when required)



- 4073750N** ..... 37-38  
Chevy car 2-speed w/ park, 12v. (will not work with stock radio). 10.150 -0.15  
..... **\$230.00 EA** ⚠
- 4089935G** ..... 39  
Chevy Car 2-speed w/ park, 12v. (will not work with stock radio). 10.150 -0.15  
..... **\$230.00 EA** ⚠
- 4109959N** ..... 40  
Chevy Car 2-speed w/ park, 12v. (will not work with stock radio). 10.150 -0.15  
..... **\$230.00 EA** ⚠
- 4115421N** ..... 41  
Chevy car 2-speed w/ park, 12v. (will not work with stock radio). 10.150 -0.15  
..... **\$230.00 EA** ⚠
- 4132637N** ..... 42-48  
Chevy car 2-speed w/ park, 12v. (will not work with stock radio). 10.150 -0.15  
..... **\$230.00 EA** ⚠
- 4089935M** ..... 47-53  
Chevy truck 2 speed & self park (6v). 16.064 -0 ..... **\$179.25 EA** ⚠
- 4089935N** ..... 47-53  
Chevy truck 2 speed & self park (12v), also fits GMC. 16.064 -0.15  
..... **\$230.50 EA** ⚠
- 4614268N** ..... 49-52  
Chevy car 2-speed w/ park, 12v. (will not work with stock radio). 10.150 -0.15  
..... **\$230.00 EA** ⚠
- 4646190N** ..... 53-54  
Chevy car 2-speed w/ park, 12v. (will not work with stock radio). 10.150 -0.15  
..... **\$230.00 EA** ⚠

**Electric Wiper Motor Chevy, cont.**

- 3710004M**..... 54  
Chevy truck 2 speed & self park (6v). Comes w/ original style knob. 16.064 -0.15  
..... **\$190.50 EA** ⚠
- 3710004N** ..... 54  
Chevy truck 2 speed & self park (12v), also fits GMC. 16.064 -0.15  
..... **\$230.00 EA** ⚠
-  **EWCHEV55**..... 55-56  
Chevrolet Passenger Car Electric Wiper Motor 12 Volt -0.15  
..... **\$230.00 EA** ⚠
-  **EWCHEV581**..... 58  
Chevrolet Passenger Car Electric Wiper Motor 12 Volt -0.15  
..... **\$230.00 EA** ⚠
-  **EWCHEV582**..... 58-62  
Chevrolet Corvette Electric Wiper Motor 12 Volt -0.15  
..... **\$230.00 EA** ⚠
-  **EWCHEV59**..... 59  
Chevrolet Passenger Car Electric Wiper Motor Bolt In Replacement -0.15  
..... **\$230.00 EA** ⚠
-  **EWCHEV60**..... 60  
Chevrolet Passenger Car Electric Wiper Motor Bolt In Replacement -0.15  
..... **\$230.00 EA** ⚠
-  **EWCHEV61**..... 61-62  
Chevrolet Passenger Car Electric Wiper Motor Bolt In Replacement -0.15  
..... **\$230.00 EA** ⚠
-  **EWCHEV62**..... 62-67  
Chevy II Nova†Chevrolet Passenger Car Electric Wiper Motor Bolt In Replacement -0.15  
..... **\$230.00 EA** ⚠
-  **EWCHEV63**..... 63-64  
Chevrolet Passenger Car Electric Wiper Motor Bolt In Replacement -0.15  
..... **\$230.00 EA** ⚠
-  **EWCHEV64**..... 64-65  
Chevrolet Chevelle Electric Wiper Motor Bolt In Replacement -0.15  
..... **\$230.00 EA** ⚠

**Wiper Motor w/ Linkage Kit**

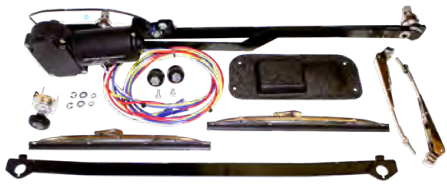

**594640KD** ..... **37-38**  
 Chevy Truck Deluxe Clean Wipe System  
 12v. Stainless wiper arms & blades.  
 16.064 -0 ..... **\$400.00 KIT** ⚠️



**598989KD** ..... **39-46**  
 Chevy Truck Deluxe Clean Wipe System  
 12v. Stainless wiper arms & blades.  
 16.064 -0 ..... **\$400.00 KIT** ⚠️



**4089935D** ..... **47-53**  
 Chevy truck W/ linkage-12v, 2-speed w/  
 delay & park (replaces old cable & spool  
 system). 10.150 -0.15 .. **\$500.00 EA** ⚠️  
**4089935S** ..... **47-53**  
 Chevy truck W/ linkage-12v, 2-speed w/  
 park (replaces old cable & spool system).  
 10.150 -0.15 ..... **\$445.25 EA** ⚠️

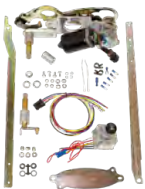

**4646190D** ..... **53-54**  
 Chevy Car 12v, 2-speed w/ delay & park  
 W/ linkage (replaces old cable & spool  
 system). 10.150 -0.15 .. **\$500.39 EA** ⚠️



**4646190S** ..... **53-54**  
 Chevy Car 12v, 2-speed w/ park. W/  
 linkage (replaces old cable & spool  
 system). 10.150 -0.15 .. **\$445.25 EA** ⚠️

**Wiper Motor Electric Kit**



**598989G** ..... **37-46**  
 Chevy truck 12v, w/ arm & blade easy  
 installation. 16.064 -0.15  
 ..... **\$197.75 EA** ⚠️



**598989H** ..... **37-46**  
 Chevy truck 6v, w/ arm & blade easy  
 installation. 16.064 -0.15  
 ..... **\$200.50 EA** ⚠️

**Electric Wiper Motor Dodge**

The Clean Wipe Wiper Drive is a true bolt-in replacement for your original equipment vacuum or electric windshield wiper motor. Each model of the Clean Wipe Wiper Drive is designed for the specific year and model of vehicle. Wiper drives attach to the stock mounting brackets. Designed for attachment to O.E.M. wiper transmission or cable drums. Our kits are 12 volt. If your vehicle is 6 volt, you will need a power inverter (NE14206). Each kit comes complete with nylon bushings to replace the rubber grommets in the wiper transmission linkage arms. (when required).

**EWDDODGE37** ..... **37-38**  
 Dodge and Plymouth Passenger Car  
 Electric Dual Wiper Conversion 12 Volt -0

..... **\$400.00 EA** ⚠️  
**EWDDODGE401** .. **40-41**  
 Dodge and Plymouth  
 Passenger Car Electric  
 Wiper Motor 12 Volt,  
 Replaces Stock Vacuum  
 Motor -0.15

..... **\$230.00 EA** ⚠️  
**EWDDODGE402** .. **40-41**  
 Dodge and Plymouth  
 Passenger Car Electric  
 Wiper Motor 12 Volt,  
 Replaces Stock Electric  
 Motor -0.15

..... **\$230.00 EA** ⚠️

**Electric Wiper Motor Dodge, cont.**



**EWDDODGE461** .. **46-48**  
 Dodge and Plymouth  
 Passenger Car Electric  
 Wiper Motor 12 Volt,  
 Replaces Stock Vacuum  
 Motor -0.15



..... **\$230.00 EA** ⚠️  
**EWDDODGE462** .. **46-48**  
 Dodge and Plymouth  
 Passenger Car Electric  
 Wiper Motor 12 Volt,  
 Replaces Stock Electric  
 Motor -0.15



..... **\$235.00 EA** ⚠️  
**EWDDODGE49** ... **49-50**  
 Dodge and Plymouth  
 Passenger Car Electric  
 Wiper Motor 12 Volt.  
 \*This kit will replace  
 factory vacuum motor  
 only. -0.15 ..... **\$230.00 EA** ⚠️

**Electric Wiper Motor Ford**

The Clean Wipe Wiper Drive is a true bolt-in replacement for your original equipment vacuum or electric windshield wiper motor. Each model of the Clean Wipe Wiper Drive is designed for the specific year and model of vehicle. Wiper drives attach to the stock mounting brackets. Designed for attachment to O.E.M. wiper transmission or cable drums. Our kits are 12 volt. If your vehicle is 6 volt, you will need a power inverter (NE14206). Each kit comes complete with nylon bushings to replace the rubber grommets in the wiper transmission linkage arms. (when required).

**EWFFORD372** ..... **37**  
 Ford Passenger Car Complete Clean Wipe  
 System -0

..... **\$400.00 EA** ⚠️  
**EWFFORD371** ..... **37-39**  
 Ford (Cabriolet, Woody, and Convertible)  
 Electric Wiper Motor 12 Volt -0.15

..... **\$230.00 EA** ⚠️  
**EWFFORD38** ..... **38**  
 Ford Passenger Car Complete Clean Wipe  
 System -0

..... **\$400.00 EA** ⚠️  
**EWFFORD39** ..... **39**  
 Ford Passenger Car  
 Deluxe and Standard  
 Electric Wiper Motor 12  
 Volt -0.15









..... **\$230.00 EA** ⚠️



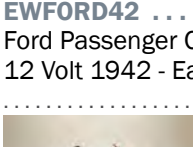

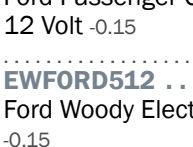
**WARNING: Cancer and Reproductive Harm** —  
[www.P65Warnings.ca.gov](http://www.P65Warnings.ca.gov)

NOTE: Any chemicals will be shipped domestic ground only (Lower 48 states only). No international shipping.

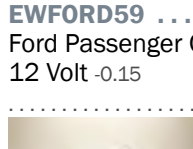

**Electric Wiper Motor Ford, cont.**

-  **EWFORD40** ..... 40  
Ford Passenger Car Electric Wiper Motor 12 Volt -0.15  
..... \$230.00 EA ⚠
-  **EWFORD41** ..... 41  
Ford Passenger Car Electric Wiper Motor 12 Volt -0.15  
..... \$230.00 EA ⚠
- EWFORD42** ..... 42-47  
Ford Passenger Car Electric Wiper Motor 12 Volt 1942 - Early 1947 -0.15  
..... \$230.00 EA ⚠
-  **EWFORD47** ..... 47-48  
Ford Passenger Car Electric Wiper Motor 12 Volt -0.15  
..... \$230.00 EA ⚠
-  **EWFORD491** ... 49-50  
Ford Passenger Car Electric Wiper Motor 12 Volt -0.15  
..... \$230.00 EA ⚠
- EWFORD492** ..... 49-50  
Ford Woody Electric Wiper Motor 12 Volt -0.15  
..... \$230.00 EA ⚠
- EWFORD511** ..... 51  
Ford Passenger Car Electric Wiper Motor 12 Volt -0.15  
..... \$230.00 EA ⚠
- EWFORD512** ..... 51  
Ford Woody Electric Wiper Motor 12 Volt -0.15  
..... \$230.00 EA ⚠
-  **EWFORD52** ..... 52-54  
Ford Passenger Car Electric Wiper Motor 12 Volt -0.15  
..... \$230.00 EA ⚠
-  **EWFORD551** ..... 55  
Ford Passenger Car Electric Wiper Motor 12 Volt, for cars with stock radio. -0.15  
..... \$230.00 EA ⚠
-  **EWFORD552** ... 55-56  
Ford Passenger Car Electric Wiper Motor 12 Volt -0.15  
..... \$230.00 EA ⚠
-  **EWFORD57** ..... 57  
Ford Passenger Car Electric Wiper Motor 12 Volt -0.15  
..... \$230.00 EA ⚠

**Electric Wiper Motor Ford, cont.**

-  **EWFORD58** ..... 58  
Ford Passenger Car Electric Wiper Motor 12 Volt -0.15  
..... \$230.00 EA ⚠
- EWFORD59** ..... 59  
Ford Passenger Car Electric Wiper Motor 12 Volt -0.15  
..... \$230.00 EA ⚠
-  **EWFORD601** ... 60-61  
Ford Passenger Car Electric Wiper Motor 12 Volt -0.15  
..... \$230.00 EA ⚠
-  **EWFORD602** ... 60-62  
Ford Falcon Electric Wiper Motor 12 Volt -0.15  
..... \$230.00 EA ⚠
-  **EWFORD63** ... 63-65  
Ford Falcon, Comet and Rancho Electric Wiper Motor 12 Volt -0.15  
..... \$230.00 EA ⚠

**Electric Wiper Motor Lincoln**



- The Clean Wipe Wiper Drive is a true bolt-in replacement for your original equipment vacuum or electric windshield wiper motor. Each model of the Clean Wipe Wiper Drive is designed for the specific year and model of vehicle. Wiper drives attach to the stock mounting brackets. Designed for attachment to O.E.M. wiper transmission or cable drums. Our kits are 12 volt. If your vehicle is 6 volt, you will need a power inverter (NE14206). Each kit comes complete with nylon bushings to replace the rubber grommets in the wiper transmission linkage arms. (when required) .
-  **EWLINC40** ..... 40-48  
Lincoln Passenger Car Electric Wiper Motor 12 Volt -0.15  
..... \$230.00 EA ⚠
  - EWLINC49** ..... 49  
Lincoln EL Electric Wiper Motor 12 Volt -0.15  
..... \$230.00 EA ⚠
  -  **EWLINC50** ..... 50  
Lincoln OL Electric Wiper Motor 12 Volt -0.15  
..... \$230.00 EA ⚠

**Electric Wiper Motor Lincoln, cont.**

-  **EWLINC51** ..... 51  
Lincoln IL Electric Wiper Motor 12 Volt -0.15  
..... \$230.00 EA ⚠
- EWLINC52** ..... 52-60  
Lincoln Passenger Car Electric Wiper Motor 12 Volt -0.15  
..... \$230.00 EA ⚠

**Electric Wiper Motor Mercury**

The Clean Wipe Wiper Drive is a true bolt-in replacement for your original equipment vacuum or electric windshield wiper motor. Each model of the Clean Wipe Wiper Drive is designed for the specific year and model of vehicle. Wiper drives attach to the stock mounting brackets. Designed for attachment to O.E.M. wiper transmission or cable drums. Our kits are 12 volt. If your vehicle is 6 volt, you will need a power inverter (NE14206). Each kit comes complete with nylon bushings to replace the rubber grommets in the wiper transmission linkage arms. (when required)

-  **EWMERC39** ... 39-40  
Mercury Passenger Car Electric Wiper Motor 12 Volt -0.15  
..... \$230.00 EA ⚠
- EWMERC41** ..... 41  
Mercury Passenger Car Electric Wiper Motor 12 Volt -0.15  
..... \$230.00 EA ⚠
- EWMERC42** ..... 42-47  
Mercury Passenger Car Electric Wiper Motor 12 Volt -0.15  
..... \$230.00 EA ⚠
- EWMERC47** ..... 47-48  
Mercury Passenger Car Electric Wiper Motor 12 Volt. Fits late 1947 vehicles. -0.15  
..... \$230.00 EA ⚠
- EWMERC49** ..... 49  
Mercury Passenger Car Electric Wiper Motor 12 Volt -0.15  
..... \$230.00 EA ⚠
-  **EWMERC50** ..... 50  
Mercury Passenger Car Electric Wiper Motor 12 Volt Note: Mounting screws on motor are spaced 5 inches center to center. -0.15  
..... \$230.00 EA ⚠
- EWMERC51** ..... 51  
Mercury Passenger Car Electric Wiper Motor 12 Volt -0.15  
..... \$230.00 EA ⚠

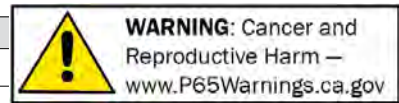

**Electric Wiper Motor Mercury, cont.**

<b>EWMERC52</b> .....	<b>.52-54</b>
Mercury Passenger Car Electric Wiper Motor 12 Volt -0.15	
.....	<b>\$230.00 EA</b> ⚠
<b>EWMERC55</b> .....	<b>.55-56</b>
Mercury Passenger Car Electric Wiper Motor 12 Volt -0.15	
.....	<b>\$230.00 EA</b> ⚠
<b>EWMERC57</b> .....	<b>.57-58</b>
Mercury Passenger Car Electric Wiper Motor 12 Volt -0.15	
.....	<b>\$230.00 EA</b> ⚠
<b>EWMERC58</b> .....	<b>58</b>
Mercury Passenger Car Electric Wiper Motor 12 Volt -0.15	
.....	<b>\$230.00 EA</b> ⚠
<b>EWMERC59</b> .....	<b>.59-60</b>
Mercury Passenger Car Electric Wiper Motor 12 Volt -0.15	
.....	<b>\$230.00 EA</b> ⚠
<b>EWMERC60</b> .....	<b>.60-62</b>
Mercury Comet Electric Wiper Motor 12 Volt -0.15	
.....	<b>\$230.00 EA</b> ⚠
<b>EWMERC61</b> .....	<b>.61-62</b>
Mercury Passenger Car Electric Wiper Motor 12 Volt -0.15	
.....	<b>\$230.00 EA</b> ⚠

**Electric Wiper Motor Oldsmobile**

The Clean Wipe Wiper Drive is a true bolt-in replacement for your original equipment vacuum or electric windshield wiper motor. Each model of the Clean Wipe Wiper Drive is designed for the specific year and model of vehicle.

Wiper drives attach to the stock mounting brackets.

Designed for attachment to O.E.M. wiper transmission or cable drums.

Our kits are 12 volt. If your vehicle is 6 volt, you will need a power inverter (NE14206). Each kit comes complete with nylon bushings to replace the rubber grommets in the wiper transmission linkage arms. (when required)

<b>EWOLDS37</b> .....	<b>.37-38</b>
Oldsmobile Passenger Car Electric Wiper Motor 12 Volt -0.15	
.....	<b>\$230.00 EA</b> ⚠
<b>EWOLDS391</b> .....	<b>39</b>
Oldsmobile Series 60 Electric Wiper Motor 12 Volt -0.15	
.....	<b>\$230.00 EA</b> ⚠
<b>EWOLDS392</b> .....	<b>.39-40</b>
Oldsmobile Series 70-80 Electric Wiper Motor 12 Volt -0.15	
.....	<b>\$230.00 EA</b> ⚠

**Electric Wiper Motor Oldsmobile, cont.**

<b>EWOLDS40</b> .....	<b>40</b>
Oldsmobile Series 70 & 90 Electric Wiper Motor 12 Volt -0.15	
.....	<b>\$230.00 EA</b> ⚠
<b>EWOLDS41</b> .....	<b>41</b>
Oldsmobile Passenger Car Electric Wiper Motor 12 Volt -0.15	
.....	<b>\$230.00 EA</b> ⚠
<b>EWOLDS42</b> .....	<b>.42-48</b>
Oldsmobile Series 60-70, 66, 76 Electric Wiper Motor 12 Volt -0.15	
.....	<b>\$230.00 EA</b> ⚠
<b>EWOLDS48</b> .....	<b>48</b>
Oldsmobile 98 Electric Wiper Motor 12 Volt -0.15	
.....	<b>\$230.00 EA</b> ⚠
<b>EWOLDS491</b> .....	<b>.49-50</b>
Oldsmobile Series 76, 88 Electric Wiper Motor 12 Volt -0.15	
.....	<b>\$230.00 EA</b> ⚠
<b>EWOLDS492</b> .....	<b>.49-51</b>
Oldsmobile 98 Electric Wiper Motor 12 Volt -0.15	
.....	<b>\$230.00 EA</b> ⚠
<b>EWOLDS51</b> .....	<b>.51-53</b>
Oldsmobile 88 & Super 88 Electric Wiper Motor 12 Volt -0.15	
.....	<b>\$230.00 EA</b> ⚠
<b>EWOLDS55</b> .....	<b>.55-56</b>
Oldsmobile Passenger Car Electric Wiper Motor 12 Volt -0.15	
.....	<b>\$230.00 EA</b> ⚠
<b>EWOLDS57</b> .....	<b>.57-58</b>
Oldsmobile Passenger Car Electric Wiper Motor 12 Volt -0.15	
.....	<b>\$230.00 EA</b> ⚠

**Electric Wiper Motor Packard**

The Clean Wipe Wiper Drive is a true bolt-in replacement for your original equipment vacuum or electric windshield wiper motor. Each model of the Clean Wipe Wiper Drive is designed for the specific year and model of vehicle. Wiper drives attach to the stock mounting brackets.

Designed for attachment to O.E.M. wiper transmission or cable drums.

Our kits are 12 volt. If your vehicle is 6 volt, you will need a power inverter (NE14206). Each kit comes complete with nylon bushings to replace the rubber grommets in the wiper transmission linkage arms. (when required)



<b>EWPACK38</b> .....	<b>.38-40</b>
Packard Passenger Car Electric Wiper Motor 12 Volt -0.15	
.....	<b>\$230.00 EA</b> ⚠

**Electric Wiper Motor Packard, cont.**



<b>EWPACK48</b> .....	<b>.48-49</b>
Packard 1948 - Early 1949 Passenger Car Electric Wiper Motor 12 Volt -0.15	
.....	<b>\$230.00 EA</b> ⚠



<b>EWPACK49</b> .....	<b>.49-56</b>
Packard Late 1949 - 1956 Passenger Car Electric Wiper Motor 12 Volt -0.15	
.....	<b>\$230.00 EA</b> ⚠

**Electric Wiper Motor Pontiac**

The Clean Wipe Wiper Drive is a true bolt-in replacement for your original equipment vacuum or electric windshield wiper motor. Each model of the Clean Wipe Wiper Drive is designed for the specific year and model of vehicle. Wiper drives attach to the stock mounting brackets.

Designed for attachment to O.E.M. wiper transmission or cable drums.

Our kits are 12 volt. If your vehicle is 6 volt, you will need a power inverter (NE14206). Each kit comes complete with nylon bushings to replace the rubber grommets in the wiper transmission linkage arms. (when required)

<b>EWPONT37</b> .....	<b>.37-38</b>
Pontiac Passenger Car Electric Wiper Motor 12 Volt -0.15	
.....	<b>\$230.00 EA</b> ⚠
<b>EWPONT391</b> .....	<b>39</b>
Pontiac Quality 6 Electric Wiper Motor 12 Volt -0.15	
.....	<b>\$230.00 EA</b> ⚠
<b>EWPONT392</b> .....	<b>39</b>
Pontiac Closed & Convertible Deluxe 6EB & 8EA Electric Wiper Motor 12 Volt -0.15	
.....	<b>\$230.00 EA</b> ⚠
<b>EWPONT401</b> .....	<b>40</b>
Pontiac Closed & Convertible 26 & 28 Electric Wiper Motor 12 Volt -0.15	
.....	<b>\$230.00 EA</b> ⚠
<b>EWPONT402</b> .....	<b>40</b>
Pontiac Closed & Convertible - Deluxe 6EB & 8EA Electric Wiper Motor 12 Volt -0.15	
.....	<b>\$230.00 EA</b> ⚠
<b>EWPONT41</b> .....	<b>41</b>
Pontiac Passenger Car Electric Wiper Motor 12 Volt -0.15	
.....	<b>\$230.00 EA</b> ⚠
<b>EWPONT42</b> .....	<b>.42-48</b>
Pontiac Passenger Car Electric Wiper Motor 12 Volt -0.15	
.....	<b>\$230.00 EA</b> ⚠

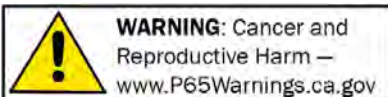

NOTE: Any chemicals will be shipped domestic ground only (Lower 48 states only). No international shipping.

**Electric Wiper Motor Pontiac, cont.**

- EWPOINT49**.....49-52  
Pontiac Passenger Car Electric Wiper Motor 12 Volt -0.15  
..... \$230.00 EA ⚠
- EWPOINT53**.....53-56  
Pontiac Passenger Car Electric Wiper Motor 12 Volt -0.15  
..... \$230.00 EA ⚠
- EWPOINT57**.....57  
Pontiac Passenger Car Electric Wiper Motor 12 Volt -0.15  
..... \$230.00 EA ⚠
- EWPOINT58**.....58  
Pontiac Passenger Car Electric Wiper Motor 12 Volt -0.15  
..... \$230.00 EA ⚠

**Wiper Switch Shaft Extensions**

- EWEXT4** .....49-50  
Two speed switch extension to use in original location for 1949-50 Ford Cars -0  
..... \$22.00 EA ⚠
- EWEXT5** .....49-50  
Delay switch extension to use in original location for 1949-50 Ford Cars -0  
..... \$22.00 EA ⚠
- EWEXT2** .....51-59  
Two speed switch extension to use in original location for 1951-59 Ford Cars -0  
..... \$22.00 EA ⚠
- EWEXT3** .....51-59  
Delay switch extension to use in original location for 1951-59 Ford Cars -0  
..... \$22.00 EA ⚠
- EWEXT1** .....55-57  
Delay speed switch extension to use in original location for 55,56,57 Chevy Car, 49,50 Oldsmobile, 55-56 Oldsmobile -0  
..... \$22.00 EA ⚠
- EWEXTC** .....55-57  
Two speed switch extension to use switch in original location with stock bezel. -0  
..... \$22.00 EA ⚠
- EWEXT7** .....59-66  
Delay switch extension to use in original location for 1959-66 Chevy Cars and 60-66 Chevy Trucks -0  
..... \$22.00 EA ⚠
- EWEXT6** .....59-75  
Two speed switch extension to use in original location for 1959-66 Chevy Cars and 60-72 Chevy Trucks -0  
..... \$22.00 EA ⚠

**Intermittent Delay Switch**



- 4073750D** .....ALL  
For electric wiper motors. 10.150 -0.15  
..... \$87.50 EA ⚠

**Electric Wiper Motor Kit -Universal**



- 598989E** .....ALL  
Universal. 6v. 3 3/16" Length x 1/4" Diameter. 16.064 -0.15  
..... \$67.00 EA ⚠



- R6558**.....ALL  
Stainless, 12 volt w/ 110 degree arm swing. Auto park.  
Metal drive gear for long life.  
Includes 11" arm with 10" blade. 3 3/16" Length x 1/4" Diameter. -0.15  
..... \$60.00 EA ⚠



- R6558BK** .....ALL  
Black, 12 volt w/ 110 degree arm swing. Auto park.  
Metal drive gear for long life.  
Includes 11" arm with 10" blade. 3 3/16" Length x 1/4" Diameter. -0.15  
..... \$61.25 EA ⚠

**Wiper Tower Covers**

Covers for wiper tower transmission hole in cowl (needed w/ #4132637E Electric Wiper Conversion Kit).



- 4103740C** .....37-39  
Chrome covers for wiper tower transmission hole in cowl (needed w/ #4132637E electric wiper conversion kit). Chevrolet 10.150 -0.15 .. \$72.00 PR ⚠
- 4103740U** .....37-39  
Unpainted covers for wiper tower transmission hole in cowl (needed w/ #4132637E electric wiper conversion kit). Chevrolet 10.150 -0.15 ... \$47.25 PR ⚠



- 4104648C** .....40-48  
Chrome covers for wiper tower transmission hole in cowl (needed w/ #4132637E electric wiper conversion kit). Chevrolet. 1940 requires modification for body line 10.150 -0.15 ... \$72.00 PR ⚠
- 4104648U** .....40-48  
Unpainted covers for wiper tower transmission hole in cowl (needed w/ #4132637E electric wiper conversion kit). 1940 needs modification for body line. 10.150 -0.15 ..... \$47.25 PR ⚠

**Wiper Caps**



- BIS248810**.....-54  
Billet Bullet cap replaces wiper arm on shaft. 11/16" or smaller shaft. 10.159 -0.15  
..... \$27.00 PR ⚠

# Section 370: Cowl Vents, Wiper Motors, Wiper Arms & Knobs

## Wiper Caps, cont.



**BIS248815** .....-54  
Billet Bullet cap replaces wiper arm on shaft. 11/16" or smaller shaft. 10.159 -0.15  
..... **\$27.00 PR** ⚠



**4601065** .....ALL  
Wiper chrome cap replaces wiper arm on shaft. 9/16" ID 10.159 -0.15  
..... **\$18.00 PR** ⚠



**4601065C** .....ALL  
Wiper chrome cap replaces wiper arm on shaft. Bullet cover. 9/16" ID 10.159 -0.15  
..... **\$17.50 PR** ⚠

## Wiper Arms & Blades



**603047R** .....31-38  
7in. stainless arm w/ 8-1/4in. blade (2 pcs). 10.146 -0.2 ..... **\$51.00 EA** ⚠

**3683907** .....31-40  
Wiper Blade Replacement For 603047R 31^38 10.146 -0 ..... **\$20.00 EA** ⚠



**603047R** .....31-40  
7in. stainless arm w/ 8-1/4in. blade (2 pcs). 10.146 -0.2 ..... **\$51.00 EA** ⚠

## Wiper Arms & Blades, cont.



**3683910A** .....ALL  
Chrome. Adjustable length and wiper angle, 6-11". Fits wiper transmissions with a 9/16" spline shaft. Use with blades NE13... 10.146 -0 ..... **CALL** ⚠



**3683910RE** .....ALL  
Billet wiper arm rubber blade only. 10.146 -0.15 ..... **\$3.00 EA** ⚠



**3683910RL** .....ALL  
Angle arm-left hand (curved windshield). 10.146 -0.15 ..... **\$46.00 SET** ⚠



**3683910RR** .....ALL  
Angle arm-right hand (curved windshield). 10.146 -0.15 ..... **\$46.00 SET** ⚠



**3683910S** .....ALL  
Straight arm-left or right (flat windshield). 10.146 -0.15 ..... **\$46.00 SET** ⚠



**3683910SA** .....ALL  
Stainless. Adjustable length and wiper angle. 6-11" Use with blades NE130... 10.146 -0.15 ..... **\$22.50 EA** ⚠



**603046R** .....ALL  
For chop top (6in. arm w/ 6in. blade). 10.146 -0.15 ..... **\$45.00 EA** ⚠



**NE13006** .....ALL  
6" stainless wiper blade for use with 3683910A adjustable wiper arm. 10.146 -0.15 ..... **\$17.50 EA** ⚠

## Wiper Arms & Blades, cont.



**NE13008** .....ALL  
8" stainless wiper blade for use with 3683910A adjustable wiper arm. 10.146 -0.15 ..... **\$17.50 EA** ⚠



**NE13010** .....ALL  
10" stainless wiper blade for use with 3683910A adjustable wiper arm. 10.146 -0.3 ..... **\$16.25 EA** ⚠



**NE13012** .....ALL  
12" stainless wiper blade for use with 3683910A adjustable wiper arm. 10.146 -0.3 ..... **\$16.25 EA** ⚠



**R6057** .....ALL  
Stainless middle insert type wiper blade - 10". -0.15 ..... **\$6.00 EA** ⚠



**R6058** .....ALL  
Stainless Middle Insert Type Wiper Arm - 11". -0.15 ..... **\$9.00 EA** ⚠

## Electric Wiper Conversion Kit



**598989K** .....39-46  
Clean Wipe System. Stainless wiper arms & blades. 16.064 -0 ..... **\$390.00 KIT** ⚠



**WARNING: Cancer and Reproductive Harm** —  
www.P65Warnings.ca.gov

NOTE: Any chemicals will be shipped domestic ground only (Lower 48 states only). No international shipping.

**(800) 952-1752 • www.streetrodhq.com**

**Hidden Hinges**

Install for standard or suicide door swing. Features include: adjustable springloaded door stops to hold doors open, GM style flanged oil-lite bushings, radiused hinge arms, 3D adjustment with 40% more adjustability than others on the market, CNC machined, hardened hardware and video install guide.



**HAGHHH** .....ALL  
10.450 -0.15 ..... **\$425.50 SET** ⚠

**Shaved Door Handle Kits -Keyless Entry**

Features: - Harness has built in safety feature to prevent door from accidentally opening while vehicle is running. - 50lb solenoids, most powerful in the industry - 4 channel multi-function remote w/ integrated alarm - (2) 4 button transmitters - Heavy gauge wire w/ plug & play harness - Heavy duty 40 amp rely pack - 1/16 pre-stretched stainless steel wire



**12992** .....ALL  
2-door system. 10.500 -0.15  
..... **\$225.25 EA** ⚠

**12993** ..... ALL  
4-door system. 10.500 -0.15  
..... **\$365.00 EA** ⚠

**Suicide Door Hinge Kit**



**99600 ALL**  
There is nothing cooler than suicide doors, and for those who want their doors to swing the other way Electric Life offers their Small Suicide

Billet Hinge Kit. designed for heavy doors and extreme loads. Each kit comes with everything you need for one door. Good welding and fabricating skills are required for installing this kit. Hinge rotates on precision ground pivot pins, fitted to bronze bushings. Hinge J-Strap is machined from solid aircraft quality billet aluminum. Strap height is 2-inches, with a depth of 3-inches and wall thickness of 3/8-inch. All mounting plates are laser cut 1/4-inch steel plate. Kit Covers One Door -0  
**\$378.25 EA** ⚠

**Suicide Door Hinge Kit, cont.**



**99610** .....ALL  
Want a suicide door solution for your smaller vehicle or rear doors? Electric-Life also offers

the 99610, Large Suicide Billet Hinge Kit. Perfect for early Ford hot rods or late model imports the 99610 is your high quality solution for suicide door operation. Hinge rotates on precision ground pivot pins, fitted to bronze bushings. Hinge J-Strap is machined from solid aircraft quality billet aluminum. Strap height is 2-1/2 inches, with a depth of 4-inches and wall thickness of 5/8-inch. All mounting plates are laser cut 1/4-inch steel plate. Kit Covers One Door -0

..... **\$442.75 EA** ⚠

**Bear Claw Latch Kits**



**TRQ-AEL07** .....47-51  
Altman easy latch set for Chevy trucks. Replace factory door latch assemblies with modern style latching mechanisms.  
16.335 -0.15 ..... **\$350.50 SET** ⚠



**TRQ-AEL08** .....52-54  
Altman Easy Latch set. Replace factory door latch assemblies, with modern style latching mechanisms. 16.335 -0.15  
..... **\$350.00 SET** ⚠



**12996** .....ALL  
Kit is complete with left & right bear claw latches, attached to power actuators, & manual cable release to insure a safe exit in case of power loss. 10.500 -0.15  
..... **\$175.09 SET** ⚠

**Bear Claw Latch Kits, cont.**



**12997** .....ALL  
Mounting kit-simplifies the installation process for your bear claw latch & makes quick work of lining up the latch with the striker. 10.500 -0.15 ..... **\$98.00 SET** ⚠

**Bear Claw Latches**

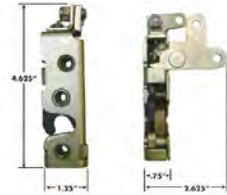

**13309** .....ALL  
Small. 10.500 -0.15 ..... **\$49.09 SET** ⚠



**13310** .....ALL  
Large. 10.500 -0.15 ..... **\$47.00 SET** ⚠  
**13311** ..... ALL  
Installation kit-small latch. 10.500 -0.15  
..... **\$49.99 SET** ⚠

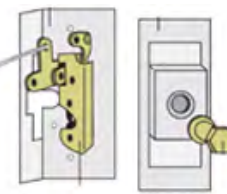

**13312** .....ALL  
Installation kit-large latch. 10.500 -0.15  
..... **\$45.00 SET** ⚠

**Door Poppers**



**99520** .....ALL  
Aluminum with plastic bumper, striker pad & adjustable plunger travel. 10.500 -0.15  
..... **\$37.75 EA** ⚠

**Door Prop**

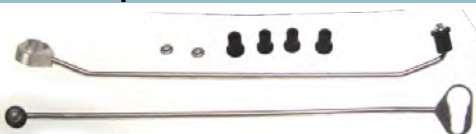

**BCPROP . . . . .ALL**  
Links your striker bolt to your latch to keep your door from being opened by wind and over zealous onlookers. For bear claw latches -0.15 . . . . . **\$55.25 PR** ⚠

**Keyless Entry Door Lock Kits**

Convert your old manual door locks to full power remote with this combination power door lock & keyless entry system. Comes with 2 four-button transmitters that can activate your locks from 100 feet away.



**12994 . . . . .ALL**  
2-door kit. 10.500 -0.15 . . **\$231.19 EA** ⚠  
**12995 . . . . .ALL**  
4-door kit. 10.500 -0.15 . . **\$348.00 EA** ⚠

**Power Door Lock Kits**

Convert your manual door locks to central locking power locks. Kits come complete with actuators, power door lock module, wire harness and a complete set of accessories for installation. Can be installed with or without keyless entry. Easily integrated with most alarms or keyless entry systems.



**13019 . . . . .ALL**  
2-door. 10.500 -0.15 . . . . **\$117.75 KIT** ⚠  
**13020 . . . . .ALL**  
4-door. 10.500 -0.15 . . . . **\$178.25 KIT** ⚠

**Electric Latch Release Triggers**

Modified Power Window Switches for positive (+) output triggering for actuators or for use as remote control trigger switches. 6 amps maximum output. "Single" switches will operate (2) actuators/doors (Push left or right). "Double" switches are for 4-door use. May be used for other positive (+) momentary switching.

**Electric Latch Release Triggers, cont.**



**WASL65BS . . . . .ALL**  
High quality waterproof button for activating solenoids or actuators. Don't use unsealed

switches! The buttons are 5/8" dia. x 1/4" tall and mount in a 1/2" hole, momentary action. 5 amps rating. 24" leads. -0.15

. . . . . **\$20.00 EA** ⚠

**Emergency Door Releases**



**13075 . . . . .ALL**  
Manual exterior door latch kit. Billet emergency entry kit. This unit provides a stationary mount with inner connected cable

pull. 10.500 -0.15

. . . . . **\$66.89 EA** ⚠

**DLR-2100 . . . . .ALL**

Shielded pulley for a more direct pulling angle  
U-Cut-to-Fit stainless steel cable wire 36"

Adjustable cable connection  
Eliminates solid rods and bell cranks  
Compatible with most door handles and latches -0.15

. . . . . **\$64.75 SET** ⚠

**WASTP-BKD-1 . . . . .ALL**

Mechanical back-up for electric driver door latch. 8+ feet of encased cable, stainless steel braided door wire loom with billet ends. Can be run through and into the door. Billet pull knob with cable clips and mounting hardware. Easily run into the engine compartment or under a fender well. -0.15

. . . . . **\$55.25 SET** ⚠

**Manual Door Latch Release Kits**

Choose from a variety of Billet Aluminum finished door latch release set styles and 3 different knob types: Smooth (1" x 1/2" dia.), Turned (1-1/16" x 3/4" w/ groove) or Ball (1" dia., polished). Each kit includes stainless trim screws. Add the remote install kit to mount your latch release away from the jamb, where ever you want on the door. Trim plates also available separately. Visit our web site or call.

**Manual Door Latch Release Kits, cont.**

Mechanical latch release for Bear Claw style latches. Match your manual door release with your power window switches for a clean looking interior. Mount vertically or horizontally. The following 2-door kits include 2 billet release levers with plates, cable, connectors, cable clips, hardware & instructions. Requires 1-1/8" clearance on backside. Also available are combo plates that include power window switches and manual door latch levers.



**WASB14 . . . . .ALL**

Round Plates are 2-1/4" dia. Stainless screws included. Plates also available separately. Choose from 3 knob types: Smooth, Turned or Ball. -0

. . . . . **starting at \$50.00 SET** ⚠



**WASB14FM . . . . .ALL**

Flamed Aluminum Plates are 1-5/8" high X 4-1/4" long. Stainless screws.†Due to the plate width, remote installation kit is required (except for use in suicide style doors). Choose from 3 knob types: Smooth, Turned or Ball. -0

. . . . . **starting at \$52.00 SET** ⚠



**WASB14NO . . . . .ALL**

Tall Oval Plates are 1" wide x 1-5/8" tall. Stainless screws included. Plates also available separately. Choose from 3 knob types: Smooth, Turned or Ball. -0

. . . . . **starting at \$50.00 SET** ⚠

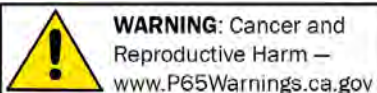

NOTE: Any chemicals will be shipped domestic ground only (Lower 48 states only). No international shipping.



**Manual Door Latch Release Kits, cont.**



**WASB140V**.....ALL  
Oval Plates are 2-1/4" wide x 1-5/8" tall. Stainless screws included. Plates also available separately. Choose from 3 knob types: Smooth, Turned or Ball. -0  
.....starting at **\$50.00 SET** ⚠



**WASB140**.....ALL  
Tall Oval Plates are 1-3/4" square. Stainless screws included. Plates also available separately. Choose from 3 knob types: Smooth, Turned or Ball. -0  
.....starting at **\$50.00 SET** ⚠



**WASB14R**.....ALL  
Allows you to install StreetWorks Neat Nobs away from the latch and door jam and/ or forward on the door original location. A "T" lever and cable are used to attach to the latch. Once installed, a simple push on the knob actuates the latch. Our works in either steel or fiberglass cars. Includes all of the hardware you need to connect a Neat Nob kit to bear-claw style latches. Detailed drawing and written instructions included. -0.15 ..... **\$18.00 SET** ⚠



**WASB19**.....ALL  
Tear drop levers. 1-5/8" high X 2-1/4" long. Stainless Screws. -0.15  
..... **\$54.00 SET** ⚠

**Manual Door Latch Release Kits, cont.**



**WASB19-CPL**.....ALL  
Chili pepper levers. 1-5/8" high X 2-1/4" long. Stainless Screws. -0.15  
..... **\$54.00 SET** ⚠

**Door Lock Knobs**



**DLK70023** .....ALL  
8 Ball Door Lock Knob -0.15  
..... **\$6.00 PR** ⚠



**DLK70044** .....ALL  
Chrome Metal Tube Door Lock Knob -0.15  
..... **\$4.50 PR** ⚠



**DLK70095** .....ALL  
Iron Cross Door Lock Knob -0.15  
..... **\$6.50 PR** ⚠



**PCW1300VB**.....ALL  
Machined aluminum, black anodized finish. -0.15  
..... **\$50.00 PR** ⚠

**Door Wire Looms**



**DLOOMBL** .....ALL  
12 inches long, stainless steel. Hides and protects wires for door controls and speakers. 10.500 -0.15  
..... **\$48.00 PR** ⚠



**DLOOMBL18**.....ALL  
18 inches long, stainless steel. Hides and protects wires for door controls and speakers. 10.500 -0.15  
..... **\$65.00 PR** ⚠

**Modular Door Contacts**



**SDXB**.....ALL  
Bottom set of modular contacts for door jam electrical connections.  
10.783 -0.15  
..... **\$7.50 PR** ⚠



**SDXM** .....ALL  
Middle set of modular contacts for door jam electrical connections. 10.783 -0.15  
..... **\$7.50 PR** ⚠



**SDXT** .....ALL  
Top set of modular contacts for door jam electrical connections. 10.783 -0.15  
..... **\$7.50 PR** ⚠

**KINDIG IT DESIGN - All New Exterior Door Handles**

These Kindig-It Design's patented smooth door handles can be modified to fit any door handle and adds a phenomenal look to your ride, while delivering simple form and function. The handles are hand-crafted in house at Kindig-It Design and can be ordered in two different finishes. The custom finish options are paintable bare metal or polished chrome.

With each set of door handles purchased, Kindig-It Design includes a step by step installation manual and template. Kindig-It Design does however recommend professional installation for optimal custom desired results.



**KID-BAR-BARE**.....ALL  
Bar Style Bare Steel 10.500 -0.15  
..... **\$595.00 SET** ⚠



**KID-BAR-CHR**.....ALL  
Bar Style Chrome Handle 10.500 -0  
..... **\$650.00 SET** ⚠

**KINDIG IT DESIGN - All New Exterior Door Handles, cont.**



**KID-SPOON-BARE** .....ALL  
Spoon Style Bare Steel 10.500 -0.15  
..... **\$595.00 SET** ⚠



**KID-SPOON-CHR** .....ALL  
Spoon Style Chrome Handle 10.500 -0  
..... **\$650.00 SET** ⚠



**KID-SQUARE-BARE** .....ALL  
Square Style Bare Steel 10.500 -0.15  
..... **\$595.00 SET** ⚠



**KID-SQUARE-CHR** .....ALL  
Square Style Chrome Handle 10.500 -0  
..... **\$650.00 SET** ⚠

**Door Handle Exterior**



**5254BDH** ..... 52-54  
GM / Chevy Billet Door Handles -0  
..... **\$350.00 L&R** ⚠

**5559BDH** ..... 55-59  
GM / Chevy Billet Door Handles -0  
..... **\$350.00 L&R** ⚠

**6066BDH** ..... 60-66  
GM / Chevy Billet Door Handles -0  
..... **\$350.00 L&R** ⚠

**Interior Door Handles (Billet Specialties)**

Choose from 3 designs with steel spline inserts and dual set-screw locking system to ensure a secure fit with easy installation. Ultra high polish finish will set your ride off in style! For matching Window & Vent Cranks see section 460.



**BIS45420** .....37-48  
Polished open design. Fits GM cars up to 1948. 10.512 -0.15 ..... **\$80.00 PR** ⚠



**BIS45520** .....49-54  
Polished open design. Fits 1949-54 vehicles. 10.512 -0.15 ..... **\$80.00 PR** ⚠



**BIS45325** .....ALL  
Polished ball milled design. Fits Ford vehicles up to 1948. -0.15  
..... **\$80.00 PR** ⚠



**BIS45328** .....ALL  
Polished rail design. Fits Ford cars up to 1948 and Ford trucks up to 1952. 3/8" Square spline. -0.15 ..... **\$90.09 PR** ⚠



**BIS45425** .....ALL  
Polished ball milled design. Fits GM vehicles up to 1948. -0.15  
..... **\$80.00 PR** ⚠

**Interior Door Handles (Billet Specialties), cont.**



**BIS45428** .....ALL  
Polished rail design. Fits GM cars up to 1948. -0.15 ..... **\$95.00 PR** ⚠



**BIS45525** .....ALL  
Polished ball milled design. Fits GM & Ford vehicles 1949 & later. -0.15  
..... **\$80.00 PR** ⚠



**BIS45525BLK** .....ALL  
Black anodized ball milled design. Fits GM & Ford vehicles 1949 & later. -0.15  
..... **\$92.00 PR** ⚠



**BIS45528** .....ALL  
Polished rail design. Fits GM & Ford vehicles 1949 & later. -0.15  
..... **\$95.00 PR** ⚠

**Interior Door Handles (Trique Manufacturing)**

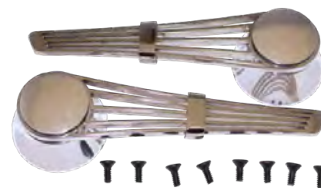

**TRQ-DL05L** .....49-54  
Polished banjo design. Sold in pairs. Each pair comes with a universal mounting hubs that work on 1/2" and 7/16" splines, as well as 3/8" square shafts. 10.512 -0.15  
..... **\$130.00 PR** ⚠



**WARNING: Cancer and Reproductive Harm** —  
www.P65Warnings.ca.gov

NOTE: Any chemicals will be shipped domestic ground only (Lower 48 states only). No international shipping.

**Interior Door Handles (Trique Manufacturing), cont.**



**TRQ-DL05E**.....ALL  
 Polished Banjo Design. Fits GM up to 1948. 10.512 -0.15 ..... **\$130.25 PR** ⚠

**Interior Door Handles**

Spice up your interior with these Billet Door Handles! Smooth operation and the finish is second to none! Advanced finish system reduces scratches while eliminating fingerprints. 3 designs: SWISH, NOTCH & CUT OFF. Machined Finish, Easy Installation. Comes with detailed instructions.



**BWDH1**.....ALL  
 Open design. -0.15 ..... **\$61.49 PR** ⚠



**BWDH2**.....ALL  
 Maltese Cross design. -0.15 ..... **\$61.49 PR** ⚠



**BWDH3**.....ALL  
 Flame design. -0.15 ..... **\$61.49 PR** ⚠



**BWDH4**.....ALL  
 Star design. -0.15 ..... **\$61.49 PR** ⚠

**Interior Door Handles, cont.**



**BZDH1K**.....ALL  
 Lever kit. Notch design. -0.15 ..... **\$97.50 PR** ⚠



**BZDH3K**.....ALL  
 Lever kit. Swish design. -0.15 ..... **\$97.50 PR** ⚠

**Custom Door Handles (Paul Atkins Signature Series)**

Beautifully finished, chrome elliptical interior door handles. Includes 3 inserts (simulated Carbon-fiber, Brushed Aluminum & Black) 4-1/2" x 2". Hidden mounting screws. 3 styles to choose from.



**CMW-EL502**.....ALL  
 Arm lever. -0.15 ..... **\$195.25 L&R** ⚠



**CMW-EL503**.....ALL  
 Oval lever. -0.15 ..... **\$195.19 L&R** ⚠



**CMW-EL504**.....ALL  
 Crescent lever. -0.15 ..... **\$195.19 L&R** ⚠



**CMW-PT102**.....ALL  
 Includes Carbon Fiber type or Black inserts. Fits GM, Ford & Chrysler vehicles -0.15 ..... **\$99.79 L&R** ⚠

**Custom Door Handles (CMW Pro-Touring Series)**



**CMW-PT202**.....ALL  
 Fit 1949 and up GM and Ford vehicles -0.15 ..... **\$120.00 L&R** ⚠

**Billet Interior Door Handles (Lokar)**

Oval Billet Aluminum Interior Door Handles  
 iRecessed mount design iComplete with mounting back plate and hardware iRubber trigger stop provides quiet return of lever i3 finishes available Polished, Brushed or Black Powdercoat).  
 Mounting hole size: 4-17/64i x 1-3/4i Includes brackets.



**IDH-2000**.....ALL  
 Brushed finish. -0.15 ... **\$214.00 PR** ⚠



**IDH-2000X**.....ALL  
 Black powder coat finish. -0.15 ..... **\$219.50 PR** ⚠



**IDH-2001**.....ALL  
 Polished finish. -0.15 ... **\$212.99 PR** ⚠



**IDH-2024**.....ALL  
 Lakester chrome finish. GM pre 1949 -0.15 ..... **\$93.00 PR** ⚠

**Billet Interior Door Handles (Lokar), cont.**



**IDH-2024X** .....ALL  
Lakester black finish. GM pre 1949. -0.15  
..... **\$93.00 PR** ⚠



**IDH-2025** .....ALL  
Lakester chrome finish. GM and Ford  
1949 and later. -0.15 ..... **\$93.00 PR** ⚠



**IDH-2025X** .....ALL  
Lakester black finish. GM and Ford 1949  
and later. -0.15 ..... **\$93.00 PR** ⚠



**IDH-2027** .....ALL  
Lakester raw finish. GM pre 1949 -0.15  
..... **\$93.00 PR** ⚠



**IDH-2028** .....ALL  
Lakester raw finish. GM and Ford 1949  
and later. -0.15 ..... **\$93.00 PR** ⚠

**Billet Interior Door Handles**

Billet Interior Door Handles in 2 sizes. Easy-to-grab release lever & cool shape that will match any interior.



**SMP22001P** .....ALL  
Large, polished finish. 5-5/8" x 2-7/8". -0  
..... **\$250.00 PR** ⚠

**SMP22001S** .....ALL  
Large, satin/ brushed finish. 5-5/8" x  
2-7/8". -0 ..... **\$230.00 PR** ⚠



**SMP22002P** .....ALL  
Small, polished finish. 4-3/4" x 2-3/8". -0  
..... **\$250.00PR** ⚠

**SMP22002S** .....ALL  
Small, satin/ brushed finish. 4-3/4" x  
2-3/8". -0 ..... **\$230.00 PR** ⚠

**Door Pulls**



**3705092H** .....ALL  
3 dimensional nude figure handle or  
hubcap ornament. Chrome, 12-1/4 in.  
length. 5.858 -0.15 ..... **\$43.19 EA** ⚠

**Interior Door/ Courtesy Lights**

Polished or brushed oval interior lights. Teardrop or oval shape with white glass lens that won't color, melt or distort from heat. Use as door courtesy light, rear quarter light, trunk light or anywhere you need additional lighting. 12 volt.



**SMP22050P** .....ALL  
Polished oval. 1-7/8" X 3-5/8"  
2" mounting depth -0.15 ..... **\$48.00 EA** ⚠

**Interior Door/ Courtesy Lights, cont.**



**SMP22050S** .....ALL  
Brushed/ satin oval. 1-7/8" X 3-5/8"  
2" mounting depth -0.15 ..... **\$43.00 EA** ⚠



**SMP22051P** .....ALL  
Polished teardrop. 3-1/8" X 1-7/8"  
mounting depth 2". -0.15 ..... **\$48.00 EA** ⚠

**SMP22051S** .....ALL  
Satin/ Brushed teardrop. 3-1/8" X 1-7/8"  
mounting depth 2". -0.15 ..... **\$43.00 EA** ⚠

**Door Pulls -Aluminum**

Convenient door pulls make it easy to close door. Choose your style and finish. Includes fasteners.



**BWDP1** .....ALL  
Brushed billet aluminum, crescent  
daytona style -0.15 ..... **\$79.25 PR** ⚠



**IDP-2002** .....ALL  
Brushed billet aluminum crescent oval  
-0.15 ..... **\$146.59 PR** ⚠



**IDP-2003** .....ALL  
Polished billet aluminum crescent oval  
-0.15 ..... **\$146.00 PR** ⚠



**WARNING: Cancer and Reproductive Harm** —  
www.P65Warnings.ca.gov

NOTE: Any chemicals will be shipped domestic ground only (Lower 48 states only). No international shipping.

**Door Pulls -Aluminum**

**IDP-2004** ..... **ALL**  
Brushed billet aluminum oval -0.15  
..... **\$142.00 PR** ⚠

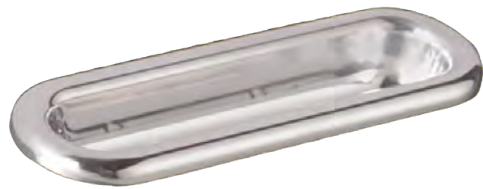

**IDP-2005** ..... **ALL**  
Polished billet aluminum oval -0.15  
..... **\$151.00 PR** ⚠

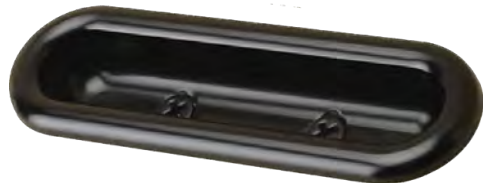

**XIDH-2004** ..... **ALL**  
Black billet aluminum oval -0.15  
..... **\$146.59 PR** ⚠



**XIDP-2002** ..... **ALL**  
Black billet aluminum crescent -0.15  
..... **\$146.59 PR** ⚠

**Door Weatherstrip**

**WSDOOR01** ..... **ALL**  
Weatherstrip, universal.  
10.694 -0.2  
..... **\$1.50 FT** ⚠



#018174

Note: We also have stock Glass for 1937-54 Chevrolet Cars and Trucks. Please call for your application.

**One Piece V-Bent Windshield Glass**

Give your vehicle that clean, customized look with a one piece windshield. No more messy silicone sealing the center seam found on V-Butt windshields. Modification required. All V-Bent windshields come with rubber seal.

Note: Oversize shipping charges apply on all windshields. Please call for rate.

**One Piece V-Bent Windshield Glass -Chevy Car**



**970V** ..... **37-38**  
Except cabriolet, clear comes w/ rubber seal. 10.027 -0.15 ..... **\$500.00 EA** ⚠

**970VCS** ..... **37-38**  
Except cabriolet. Clear w/ shaded top. Comes with rubber windshield gasket. 10.027 -0.15 ..... **\$540.00 EA** ⚠

**970VG** ..... **37-38**  
Except cabriolet. Tinted grey 10.027 -0.15 ..... **\$448.00 EA** ⚠

**970VGS** ..... **37-38**  
Except Cabriolet. Tinted Grey w/ shaded top. Comes with rubber windshield gasket. 10.027 -0.15 ..... **\$467.00 EA** ⚠

**970VT** ..... **37-38**  
Except cabriolet, tinted green. Comes w/ rubber 10.027 -0.15 ..... **\$448.79 EA** ⚠

**970VTS** ..... **37-38**  
Except cabriolet. Tinted green w/ shaded top. Comes with rubber windshield gasket. 10.027 -0.15 ..... **\$469.00 EA** ⚠

**1020V** ..... **39**  
Clear. Comes w/ rubber. 10.027 -0.15 ..... **\$415.00 EA** ⚠

**1020VCS** ..... **39**  
Clear w/ shaded top. Comes w/ rubber seal. 10.027 -0.15 ..... **\$437.50 EA** ⚠

**1020VG** ..... **39**  
Tinted Grey. Comes w/ rubber seal. 10.027 -0.15 ..... **\$445.25 EA** ⚠

**1020VGS** ..... **39**  
Tinted grey w/ shaded top. Comes w/ rubber seal. 10.027 -0.15 ..... **\$461.25 EA** ⚠

**1020VT** ..... **39**  
Tinted green. Comes w/ rubber 10.027 -0.15 ..... **\$450.00 EA** ⚠

**1020VTS** ..... **39**  
Tinted green w/ shaded top. Comes w/ rubber seal. 10.027 -0.15 ..... **\$421.25 EA** ⚠

**1007V** ..... **40**  
Clear. Comes w/ rubber seal. 10.027 -0.15 ..... **\$400.00 EA** ⚠

**One Piece V-Bent Windshield Glass -Chevy Car, cont.**

**1007VCS** ..... **40**  
Clear w/ shaded top. Comes w/ rubber seal. 10.027 -0.15 ..... **\$520.00 EA** ⚠

**1007VG** ..... **40**  
Tinted grey. Comes w/ rubber seal. 10.027 -0.15 ..... **\$539.99 EA** ⚠

**1007VGS** ..... **40**  
Tinted grey with shaded top. Comes w/ rubber seal. 10.027 -0.15 ..... **\$496.00 EA** ⚠

**1007VT** ..... **40**  
Tinted green. Comes w/ rubber seal. 10.027 -0.15 ..... **\$500.00 EA** ⚠

**1007VTS** ..... **40**  
Tinted green with shaded top. Comes w/ rubber seal. 10.027 -0.15 ..... **\$529.99 EA** ⚠



**1019V** ..... **41-48**  
Except 2-door Fleetline. Clear, comes with rubber seal 10.027 -0.15 ..... **\$439.25 EA** ⚠

**1019VCS** ..... **41-48**  
Clear w/ shaded top. Except 2-door Fleetline. Comes w/ rubber seal. 10.027 -0.15 ..... **\$530.00 EA** ⚠

**1019VG** ..... **41-48**  
Except 2-door Fleetline. Tinted grey 10.027 -0.15 ..... **\$480.59 EA** ⚠

**1019VGS** ..... **41-48**  
Except 2-door Fleetline. Tinted grey w/ shaded top. Comes w/ rubber seal. 10.027 -0.15 ..... **\$559.99 EA** ⚠

**1019VT** ..... **41-48**  
Except 2-door Fleetline. Tinted green, comes w/ rubber seal 10.027 -0.15 ..... **\$445.00 EA** ⚠

**1019VTS** ..... **41-48**  
Tinted green w/ shaded top. Except 2-door Fleetline. Comes w/ rubber seal. 10.027 -0.15 ..... **\$499.00 EA** ⚠

**1042V** ..... **42-48**  
Clear. Fits 2 door Fleetline Aerosedan. Comes w/ rubber seal. 10.027 -0 ..... **CALL** ⚠

**1042VCS** ..... **42-48**  
Clear w/ shaded top. Fits 2 door Fleetline Aerosedan. Comes w/ rubber seal. 10.027 -0 ..... **CALL** ⚠

**1042VT** ..... **42-48**  
Tinted green. Fits 2 door Fleetline Aerosedan. Comes w/ rubber seal. 10.027 -0 ..... **CALL** ⚠

**1042VTS** ..... **42-48**  
Tinted green w/ shaded top. Fits 2 door Fleetline Aerosedan. Comes w/ rubber seal. 10.027 -0 ..... **CALL** ⚠

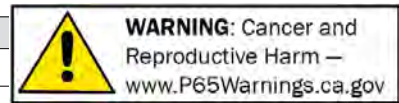

## Section 420: Glass

### One Piece V-Bent Windshield Glass -Chevy Truck

Give your truck that clean, customized look with a one piece windshield. No more messy silicone sealing the center seam found on V-Butt windshields. All V-Bent windshields come with rubber seal.



<b>1021V</b> .....	<b>39-46</b>
Clear. 16.005 -0.15 .....	<b>\$368.00 EA</b> ⚠
<b>1021VCS</b> .....	<b>39-46</b>
Clear w/ shaded top. 16.005 -0.15 .....	<b>\$440.00 EA</b> ⚠
<b>1021VT</b> .....	<b>39-46</b>
Tinted Green. 16.005 -0.15 .....	<b>\$410.00 EA</b> ⚠
<b>1021VTS</b> .....	<b>39-46</b>
Tinted w/ shaded top. 16.005 -0.15 .....	<b>\$430.00 EA</b> ⚠



<b>4235V</b> .....	<b>47-53</b>
Clear. 10.027 -0.15 .....	<b>\$420.00 EA</b> ⚠
<b>4235VCS</b> .....	<b>47-53</b>
Clear w/ shaded top. 10.027 -0.15 .....	<b>\$449.99 EA</b> ⚠
<b>4235VG</b> .....	<b>47-53</b>
Tinted grey. 10.027 -0.15 .....	<b>\$439.50 EA</b> ⚠
<b>4235VGS</b> .....	<b>47-53</b>
Tinted grey w/ shaded top. 10.027 -0.15 .....	<b>\$449.99 EA</b> ⚠
<b>4235VT</b> .....	<b>47-53</b>
Tinted green 10.027 -0.15 .....	<b>\$430.00 EA</b> ⚠
<b>4235VTS</b> .....	<b>47-53</b>
Tinted green w/ shaded top. 10.027 -0.15 .....	<b>\$460.00 EA</b> ⚠

### One Piece Curved Windshield Glass -Chevy Car

<b>DW187</b> .....	<b>49-52</b>
Styleline (exc Convertible, Hardtop & Wagon). 1 piece for customs. Clear. 10.027 -0.15 .....	<b>\$399.75 EA</b> ⚠
<b>DW187G</b> .....	<b>49-52</b>
Fits Styleline (exc Convertible, Hardtop & Wagon). 1 piece for customs. Tinted Grey. 10.027 -0.15 .....	<b>\$418.00 EA</b> ⚠
<b>DW187GS</b> .....	<b>49-52</b>
Fits Styleline (exc Convertible, Hardtop & Wagon). 1 piece for customs. Tinted Grey w/ shaded top. 10.027 -0.15 .....	<b>\$452.29 EA</b> ⚠

### One Piece Curved Windshield Glass -Chevy Car, cont.

<b>DW187S</b> .....	<b>49-52</b>
Fits Styleline (exc Convertible, Hardtop & Wagon). 1 piece for customs. Tinted Green w/ shaded top. 10.027 -0.15 .....	<b>\$422.09 EA</b> ⚠
<b>DW187T</b> .....	<b>49-52</b>
Fits Styleline (exc Convertible, Hardtop & Wagon). 1 piece for customs. Tinted Green. 10.027 -0.15 .....	<b>\$392.00 EA</b> ⚠
<b>DW188</b> .....	<b>49-52</b>
Fits Fleetline Areosedan-1 piece for customs. Clear. 10.027 -0.15 .....	<b>\$409.99 EA</b> ⚠
<b>DW188G</b> .....	<b>49-52</b>
Fits Fleetline Areosedan. 1 piece for customs. Tinted Grey. 10.027 -0.15 .....	<b>\$428.00 EA</b> ⚠
<b>DW188GS</b> .....	<b>49-52</b>
Fits Fleetline Areosedan. 1 piece for customs. Tinted Grey w/ shaded top. 10.027 -0.15 .....	<b>\$462.00 EA</b> ⚠
<b>DW188S</b> .....	<b>49-52</b>
Fits Fleetline Areosedan. 1 piece for customs. Tinted Green w/ shaded top. 10.027 -0.15 .....	<b>\$432.25 EA</b> ⚠
<b>DW188T</b> .....	<b>49-52</b>
Fits Fleetline Areosedan. 1 piece for customs. Tinted Green 10.027 -0.15 .....	<b>\$400.00 EA</b> ⚠



<b>DW189</b> .....	<b>49-52</b>
Fits Convertible & Hardtop. 1 piece for customs. Clear. 10.027 -0.15 .....	<b>\$409.99 EA</b> ⚠
<b>DW189G</b> .....	<b>49-52</b>
Fits Convertible & Hardtop. 1 piece for customs. Tinted Grey. 10.027 -0.15 .....	<b>\$392.00 EA</b> ⚠
<b>DW189GS</b> .....	<b>49-52</b>
Fits Convertible & Hardtop. 1 piece for customs. Tinted Grey w/ shaded top. 10.027 -0.15 .....	<b>\$472.00 EA</b> ⚠
<b>DW189S</b> .....	<b>49-52</b>
Fits Convertible & Hardtop. 1 piece for customs. Tinted Green w/ shaded top. 10.027 -0.15 .....	<b>\$442.00 EA</b> ⚠
<b>DW189T</b> .....	<b>49-52</b>
Fits Convertible & Hardtop. 1 piece for customs. Tinted Green. 10.027 -0.15 .....	<b>\$392.00 EA</b> ⚠

### One Piece V-Bent Windshield Glass -Ford/Mercury Car

Note: Windshield glass dark tint unavailable. All glass is custom made. Oversize shipping charges apply on all windshields. Please call for rate.

For all glass for 1937-54 Chevy cars or trucks refer to our restoration catalogs or visit Chevs of the 40's online:

www.chevsofthe40s.com

<b>971V</b> .....	<b>37-39</b>
Clear. Comes w/ rubber seal. -0.15 .....	<b>\$486.00 EA</b> ⚠
<b>971VCS</b> .....	<b>37-39</b>
Clear w/ shaded top. Comes w/ rubber seal. -0.15 .....	<b>\$441.00 EA</b> ⚠
<b>971VT</b> .....	<b>37-39</b>
Tinted. Comes w/ rubber seal. -0.15 .....	<b>\$430.50 EA</b> ⚠



<b>971VTS</b> .....	<b>37-39</b>
Tinted w/ shaded top. Comes w/ rubber seal. -0.15 .....	<b>\$441.00 EA</b> ⚠
<b>1006VCS</b> .....	<b>40</b>
Clear w/ shaded top. Comes w/ rubber seal. 40 Coupe, Sedan & Wagon. -0.15 .....	<b>\$520.00 EA</b> ⚠
<b>1006VT</b> .....	<b>40</b>
Tinted. Comes w/ rubber seal. 40 Coupe, Sedan & Wagon. -0.15 .....	<b>\$430.50 EA</b> ⚠
<b>1006VTS</b> .....	<b>40</b>
Tinted w/ shaded top. Comes w/ rubber seal. 40 Coupe, Sedan & Wagon. -0.15 .....	<b>\$520.00 EA</b> ⚠
<b>4085V</b> .....	<b>41-48</b>
Clear. Comes w/ rubber seal. 41-48 merc & 41-48 Ford Coupe, Sedan & Wagon. -0.15 .....	<b>\$420.00 EA</b> ⚠
<b>4085VCS</b> .....	<b>41-48</b>
Clear w/ shaded top. Comes w/ rubber seal. -0.15 .....	<b>\$510.00 EA</b> ⚠
<b>4085VT</b> .....	<b>41-48</b>
Tinted. Comes w/ rubber seal. -0.15 .....	<b>\$483.00 EA</b> ⚠
<b>4085VTS</b> .....	<b>41-48</b>
Tinted w/ shaded top. Comes w/ rubber seal. -0.15 .....	<b>\$441.00 EA</b> ⚠
<b>1067V</b> .....	<b>49-51</b>
Clear. Comes w/ rubber seal. 49-51 Merc. -0.15 .....	<b>\$420.00 EA</b> ⚠
<b>1067VCS</b> .....	<b>49-51</b>
Clear w/ shaded top. Comes w/ rubber seal. 49-51 Merc. -0.15 .....	<b>\$441.00 EA</b> ⚠
<b>1067VT</b> .....	<b>49-51</b>
Tinted. Comes w/ rubber seal. 49-51 Merc. -0.15 .....	<b>\$430.50 EA</b> ⚠



**WARNING:** Cancer and Reproductive Harm —  
www.P65Warnings.ca.gov

NOTE: Any chemicals will be shipped domestic ground only (Lower 48 states only). No international shipping.

(800) 952-1752 • www.streetrodhq.com

**One Piece V-Bent Windshield Glass -Ford/Mercury Car, cont.**

<b>1067VTS</b> .....	<b>49-51</b>
Tinted w/ shaded top. Comes w/ rubber seal. 49-51 Merc. -0.15	
	<b>\$441.00 EA</b> ⚠
<b>1070V</b> .....	<b>49-51</b>
Clear. Comes w/ rubber seal. 49-51 Ford Coupe & Sedan. -0.15	
	<b>\$449.39 EA</b> ⚠
<b>1070VCS</b> .....	<b>49-51</b>
Clear w/ shaded top. Comes w/ rubber seal. 49-51 Ford Coupe & Sedan. -0.15	
	<b>\$441.00 EA</b> ⚠
<b>1070VT</b> .....	<b>49-51</b>
Tinted. Comes w/ rubber seal. 49-51 Ford Coupe & Sedan. -0.15	
	<b>\$460.00 EA</b> ⚠
<b>1070VTS</b> .....	<b>49-51</b>
Tinted w/ shaded top. Comes w/ rubber seal. 49-51 Ford Coupe & Sedan. -0.15	
	<b>\$441.00 EA</b> ⚠

**Windshield Glass**

Specify 1 or 2 piece

<b>SRGLASSWINDC</b> .....	<b>.ALL</b>
Windshield glass, Clear. Specify year, make and model. Flat glass only. -0.15	
	<b>\$88.50</b> ⚠
<b>SRGLASSWINDG</b> .....	<b>.ALL</b>
Windshield glass, Grey. Specify year, make and model. Flat glass only. -0	
	<b>\$117.50</b> ⚠
<b>SRGLASSWINDS</b> .....	<b>.ALL</b>
Windshield glass, Clear w/shaded top. Specify year, make and model. Flat glass only. -0.15	
	<b>\$122.00</b> ⚠
<b>SRGLASSWINDT</b> .....	<b>.ALL</b>
Windshield glass, Green. Specify year, make and model. Flat glass only. -0	
	<b>\$94.00</b> ⚠

**Back Glass & Frame Chevy Truck**

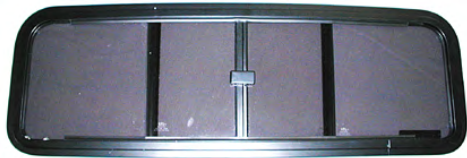

<b>3704319C</b> .....	<b>.47-54</b>
Slider, with snap closer. Smoke tinted glass. Black frame. 16.464 -0	
	<b>\$169.50 EA</b> ⚠

**Back Glass**

<b>2720SD</b> .....	<b>.47-54</b>
Tinted Grey 16.174 -0.15	
	<b>\$58.00 EA</b> ⚠
<b>SRGLASSBACKC</b> .....	<b>.ALL</b>
Back glass, Clear. Specify year, make and model. Flat glass only. -0.4	
	<b>\$235.89</b> ⚠
<b>SRGLASSBACKG</b> .....	<b>.ALL</b>
Back glass, Grey. Specify year, make and model. Flat glass only. -0	
	<b>\$290.00</b> ⚠

**Back Glass, cont.**

<b>SRGLASSBACKT</b> .....	<b>.ALL</b>
Back glass, Green. Specify year, make and model. Flat glass only. -0	
	<b>\$270.00</b> ⚠

**Door Glass**

<b>SRGLASSFDOORC</b> .....	<b>.ALL</b>
Front door glass, Clear. Specify year, make and model. Flat glass only. -0.15	
	<b>\$51.79</b> ⚠
<b>SRGLASSFDOORG</b> .....	<b>.ALL</b>
Front door glass, Grey. Specify year, make and model. Flat glass only. -0	
	<b>\$97.00</b> ⚠
<b>SRGLASSFDOORT</b> .....	<b>.ALL</b>
Front door glass, Green. Specify year, make and model. Flat glass only. -0.15	
	<b>\$86.90</b> ⚠
<b>SRGLASSRDOORC</b> .....	<b>.ALL</b>
Rear door glass, Clear. Specify year, make and model. Flat glass only. -0.15	
	<b>\$64.50</b> ⚠
<b>SRGLASSRDOORG</b> .....	<b>.ALL</b>
Rear door glass, grey. Specify year, make and model. Flat glass only. -0	
	<b>\$84.75</b> ⚠
<b>SRGLASSRDOORT</b> .....	<b>.ALL</b>
Rear door glass, Green. Specify year, make and model. Flat glass only. -0	
	<b>\$67.75</b> ⚠

**Vent Glass**

<b>SRGLASSFVENTC</b> .....	<b>.ALL</b>
Front door vent glass, Clear. Specify year, make and model. Flat glass only. -0.15	
	<b>\$40.19</b> ⚠
<b>SRGLASSFVENTG</b> .....	<b>.ALL</b>
Front door vent glass, Grey. Specify year, make and model. Flat glass only. -0	
	<b>\$51.75</b> ⚠
<b>SRGLASSFVENTT</b> .....	<b>.ALL</b>
Front door vent glass, Green. Specify year, make and model. Flat glass only. -0.15	
	<b>\$41.50</b> ⚠
<b>SRGLASSRVENTC</b> .....	<b>.ALL</b>
Rear door vent glass, Clear. Specify year, make and model. Flat glass only. -0	
	<b>\$77.00</b> ⚠
<b>SRGLASSRVENTG</b> .....	<b>.ALL</b>
Rear door vent glass, Grey. Specify year, make and model. Flat glass only. -0	
	<b>\$87.50</b> ⚠
<b>SRGLASSRVENTT</b> .....	<b>.ALL</b>
Rear door vent glass, Green. Specify year, make and model. Flat glass only. -0	
	<b>\$77.00</b> ⚠

**Quarter Glass**

<b>SRGLASSQUARTC</b> .....	<b>.ALL</b>
Quarter glass, Clear. Specify year, make and model. Flat glass only. -0.2	
	<b>\$69.19</b> ⚠
<b>SRGLASSQUARTG</b> .....	<b>.ALL</b>
Quarter glass, Grey. Specify year, make and model. Flat glass only. -0	
	<b>\$110.25</b> ⚠
<b>SRGLASSQUARTT</b> .....	<b>.ALL</b>
Quarter glass, Specify year, make and model. Flat glass only. -0.2	
	<b>\$88.25</b> ⚠



**Vent Window Removal Kit**



**HAGUWC** .....ALL  
 Universal kit for 1 piece door glass. Requires welding. Order sill strips (pt#HAGWSRS) to straighten sill angle w/ vent window removed. 10.656 -0.15  
 ..... **\$125.25 L&R** ⚠



**HAGWSRS** .....ALL  
 18 ga. replacement sill strips. Use to convert to 1-piece door glass to straighten angle once vent window removed. Use w/ pt# HAGUWC. 30" length. 10.656 -0.15  
 ..... **\$35.00 SET** ⚠

**Seal -Front Of Quarter Glass**



**WSWIN01** .....ALL  
 Forms a seal between front door glass and quarter window glass.

Ideal for street rod sedans where the "B" pillar has been removed to create a hardtop. 11.015 -0.3  
 ..... **\$2.75 FT** ⚠

**Glass Setting Tape**

**603954BULK^** .....ALL  
 1/32 in. thick, sold by the inch 10.696 -0.4



**603955BULK^** .....ALL  
 Setting tape 1/16 in. thick sold by the inch 10.696 -0.15  
 ..... **\$0.10 IN** ⚠

**Power Window Conversion -Cable Driven**

These kits come complete with two cable drive regulators. Uses heavy duty OEM style motors (switches & harness sold separately)

**3684164** ..... **51-54**

Trucks WITH vent window. Bolt in. Does NOT include switches or wiring harness (sold separately). 16.180 -0.15

..... **\$414.00 PR** ⚠

**Power Window Conversion -Cable Driven, cont.**



**13231BC** .....ALL  
 16.180 -0.15  
 ..... **\$145.50 EA** ⚠

**Gear Driven Power Window Kits Chevy Car**

Power window conversion directly bolts into original mounting holes (except kits to remove vent windows), 1018 cold rolled steel, brass oilite thrust bearings, gear teeth treated for long life (cryogenics), delco OEM motors. Includes delco OEM chrome or illuminated switches, conduit for wiring and carries a lifetime warranty.



**3657495** ..... **37-39**  
 2 door, front doors only. Also fits Pontiac 16.180 -0 ..... **\$473.25 PR** ⚠

**3657495V** ..... **37-39**  
 Power window conversion, 2DR coupe - for removed vent windows, front doors only. Modification required -0

..... **\$627.00 PR** ⚠  
**3657495V1** ..... **37-39**

Chevy 2DR sedan power window conversion. Front doors only, for removed vent windows. Modification required -0

..... **\$627.00 PR** ⚠

**3657496** ..... **40-48**

Power window conversion. Bolt in, gear drive, 2DR 16.180 -0 ..... **\$473.25 PR** ⚠

**3657496V** ..... **40-48**  
 Chevy 2DR coupe power window conversion. Front doors only, for removed vent windows. Modification required -0

..... **\$627.00 PR** ⚠

**3657496V1** ..... **40-48**

Chevy 2DR sedan power window conversion. Front doors only, for removed vent windows. Modification required -0

..... **\$627.00 PR** ⚠

**3657497** ..... **49-52**

Power window conversion. Bolt in, gear drive, 2DR 16.180 -0 ..... **\$474.00 PR** ⚠

**3657497A** ..... **49-52**  
 4-door. 16.180 -0 ..... **\$925.00 SET** ⚠

**Gear Driven Power Window Kits Chevy Car, cont.**

**3657497B** ..... **49-52**  
 Sedan Delivery 16.180 -0 .. **\$474.00 PR** ⚠

**3657497HC** ..... **49-52**

Chevy 2DR hardtop & convertible power window conversion. Front doors & rear quarter. -0

..... **\$925.00 SET** ⚠

**3657498** ..... **53-54**

Power window conversion. Bolt in, gear drive, All 2 door including hardtop and convertible (exc sedan delivery). 16.180 -0

..... **\$474.00 PR** ⚠

**3657498A** ..... **53-54**  
 4-door. 16.180 -0 ..... **\$925.00 SET** ⚠

**3657498AF** ..... **53-54**  
 4-door front doors only and sedan delivery. 16.180 -0 ..... **\$474.00 SET** ⚠

**3657498HC** ..... **53-54**

Chevy hardtop & convertible power window conversion. Front doors & rear quarter. -0

..... **\$925.00 SET** ⚠

**PWCHEV551** ..... **55-57**

Chevy 2DR sedan coupe & convertible power window conversion, bolt in, front doors only -0

..... **\$474.00 PR** ⚠

**PWCHEV5510** ..... **55-57**

Chevy 4DR sedan power window conversion. Bolt in, front doors & rear quarters -0

..... **\$925.00 SET** ⚠

**PWCHEV5511** ..... **55-57**

Chevy 4DR sedan power window conversion. Front doors only, for removal of vent windows. Modification required -0

..... **\$627.00 PR** ⚠

**PWCHEV5512** ..... **55-57**

Chevy 4DR sedan power window conversion. Front doors & rear quarters, for removal of vent windows. Modification required -0

..... **\$1,071.00 SET** ⚠

**PWCHEV5513** ..... **55-57**

Chevy Nomad power window conversion. Bolt in, front doors only -0

..... **\$474.00 PR** ⚠

**PWCHEV5514** ..... **55-57**

Chevy Nomad power window conversion. Front doors only, for removal of vent windows. Modification required -0

..... **\$627.00 PR** ⚠

**PWCHEV552** ..... **55-57**

Chevy 2DR sedan coupe & convertible power window conversion. Front doors only, for removed vent windows. Modification required -0

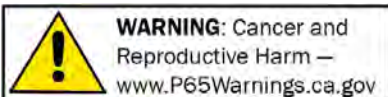

NOTE: Any chemicals will be shipped domestic ground only (Lower 48 states only). No international shipping.



# Section 460: Door Glass Channel, Window Crank, Window Regulator & Power Window Kits

## Gear Driven Power Window Kits Chevy Car, cont.

<b>PWCHEV553</b> .....	55-57
Chevy 2DR hardtop power window conversion. Bolt in, front doors & rear quarter -0	
.....	<b>\$925.00 SET</b> ⚠
<b>PWCHEV554</b> .....	55-57
Chevy 2DR hardtop power window conversion. Front doors & rear quarters, for removed vent windows -0	
.....	<b>\$1,071.00 SET</b> ⚠
<b>PWCHEV555</b> .....	55-57
Chevy 2DR sedan power window conversion. Bolt in, front doors & rear quarters -0	
.....	<b>\$925.00 SET</b> ⚠
<b>PWCHEV556</b> .....	55-57
Chevy 2DR sedan power window conversion. Front doors & rear quarters, for removing vent window. Modification required -0	
.....	<b>\$1,071.00 SET</b> ⚠
<b>PWCHEV557</b> .....	55-57
Chevy convertible power window conversion. Bolt in, front doors & rear quarters -0	
.....	<b>\$925.00 SET</b> ⚠
<b>PWCHEV558</b> .....	55-57
Chevy convertible power window conversion. Front doors & rear quarters, for removing vent window. Modification required -0	
.....	<b>\$1,071.00 SET</b> ⚠
<b>PWCHEV559</b> .....	55-57
Chevy 4DR sedan power window conversion. Bolt in, front doors only -0	
.....	<b>\$474.00 PR</b> ⚠
<b>PWCHEV561</b> .....	56-57
Chevy 4DR hardtop power window conversion. Bolt in, front doors & rear quarters -0	
.....	<b>\$1,003.00 SET</b> ⚠
<b>PWCHEV562</b> .....	56-58
Chevy Corvette power window conversion. Bolt in, front doors only -0	
.....	<b>\$522.00 PR</b> ⚠
<b>PWCHEV581</b> .....	58
Chevy Impala 2DR sedan & convertible power window conversion. Bolt in, front doors only -0	
.....	<b>\$474.00 PR</b> ⚠
<b>PWCHEV582</b> .....	58
Chevy Impala 2DR hardtop power window conversion. Bolt on, front doors & rear quarters -0	
.....	<b>\$970.00 SET</b> ⚠
<b>PWCHEV583</b> .....	58
Chevy Impala convertible power window conversion. Bolt in, front doors & rear quarters -0	
.....	<b>\$970.00 SET</b> ⚠

## Gear Driven Power Window Kits Chevy Car

<b>PWCHEV592</b> .....	59-60
Chevy El Camino power window conversion. Bolt in, front doors -0	
.....	<b>\$474.00 PR</b> ⚠
<b>PWCHEV593</b> .....	59-60
Chevy Impala 2DR coupe, sedan & convertible power window conversion. Bolt in, front doors -0	
.....	<b>\$474.00 PR</b> ⚠
<b>PWCHEV594</b> .....	59-60
Chevy Impala 2DR hardtop power window conversion. Bolt in, front doors & rear quarters -0	
.....	<b>\$925.00 SET</b> ⚠
<b>PWCHEV595</b> .....	59-60
Chevy Impala 2DR convertible power window conversion. Bolt in, front doors & rear quarters -0	
.....	<b>\$925.00 SET</b> ⚠
<b>PWCHEV596</b> .....	59-60
Chevy Impala 4DR sedan & wagon power window conversion. Bolt in, front doors only -0	
.....	<b>\$474.00 PR</b> ⚠
<b>PWCHEV597</b> .....	59-60
Chevy Impala 4DR sedan & wagon power window conversion. Bolt in, front & rear doors -0	
.....	<b>\$925.00 SET</b> ⚠
<b>PWCHEV591</b> .....	59-62
Chevy Corvette power window conversion. Bolt in, front doors -0	
.....	<b>\$522.00 PR</b> ⚠
<b>PWCHEV611</b> .....	61
Chevy Impala 2DR coupe, Sedan & convertible power window conversion. Bolt in, front doors only -0	
.....	<b>\$474.00 PR</b> ⚠
<b>PWCHEV612</b> .....	61
Chevy Impala 2DR hardtop power window conversion. Bolt in, front doors & rear quarters -0	
.....	<b>\$925.00 SET</b> ⚠
<b>PWCHEV613</b> .....	61
Chevy Impala 2DR convertible power window conversion. Bolt in, front doors & rear quarters -0	
.....	<b>\$925.00 SET</b> ⚠
<b>PWCHEV614</b> .....	61
Chevy Impala 2DR sedan power window conversion. Bolt in, front doors & rear quarters -0	
.....	<b>\$925.00 SET</b> ⚠
<b>PWCHEV621</b> .....	62
Chevy Impala 2DR coupe, sedan & convertible power window conversion. Bolt in, front doors only -0	
.....	<b>\$474.00 PR</b> ⚠

## Gear Driven Power Window Kits Chevy Car, cont.

<b>PWCHEV622</b> .....	62
Chevy Impala 2DR hardtop power window conversion. Bolt in, front doors & rear quarters -0	
.....	<b>\$925.00 SET</b> ⚠
<b>PWCHEV624</b> .....	62
Chevy Impala 2DR convertible power window conversion. Bolt in, front doors & rear quarters -0	
.....	<b>\$925.00 SET</b> ⚠
<b>PWCHEV632</b> .....	63-64
Chevy Impala 2DR coupe, sedan & convertible power window conversion. Bolt in, front doors only -0	
.....	<b>\$474.00 PR</b> ⚠
<b>PWCHEV633</b> .....	63-64
Chevy Impala 2DR hardtop power window conversion. Bolt in, front doors & rear quarters -0	
.....	<b>\$925.00 SET</b> ⚠
<b>PWCHEV634</b> .....	63-64
Chevy Impala 2DR sedan power window conversion. Bolt in, front doors & rear quarters -0	
.....	<b>\$925.00 SET</b> ⚠
<b>PWCHEV635</b> .....	63-64
Chevy Impala 2DR convertible power window conversion. Bolt in, front doors & rear quarters -0	
.....	<b>\$925.00 SET</b> ⚠
<b>PWCHEV631</b> .....	63-67
Chevy Corvette power window conversion. Bolt in, front doors only -0	
.....	<b>\$522.00 PR</b> ⚠
<b>PWCHEV636</b> .....	63-67
Chevy Nova 2DR coupe & convertible power window conversion. Bolt in, front doors only -0	
.....	<b>\$474.00 PR</b> ⚠
<b>PWCHEV638</b> .....	63-67
Chevy Nova 2DR hardtop power window conversion. Bolt in, front doors & rear quarters -0	
.....	<b>\$925.00 SET</b> ⚠
<b>PWCHEV639</b> .....	63-67
Chevy Nova 2DR convertible power window conversion. Bolt in, front doors & rear quarters -0	
.....	<b>\$925.00 SET</b> ⚠

Returns require a return authorization number—Please call first. · Note: Product pricing and availability subject to change.



**WARNING:** Cancer and Reproductive Harm — [www.P65Warnings.ca.gov](http://www.P65Warnings.ca.gov)

**Gear Driven Power Window Kits  
Chevy Truck**

Power window conversion directly bolts into original mounting holes (except kits to remove vent windows), 1018 cold rolled steel, brass oilite thrust bearings, gear teeth treated for long life (cryogenics), delco OEM motors. Includes delco OEM chrome or illuminated switches, conduit for wiring and carries a lifetime warranty.



- 3684175** ..... **36-46**  
1936-46 Chevy truck. Complete kit with chrome or black switches. 16.180 -0  
..... **\$524.00 PR** ⚠
- 3684176** ..... **47-50**  
1947-50 Chevy truck. Complete kit with chrome or black switches. Fits Suburban & COE also 16.180 -0 .. **\$473.25 PR** ⚠
- 3684177** ..... **51-54**  
1951-54 Chevy Truck, Panel Truck, Suburban and COE. Complete kit with chrome or black switches. 16.180 -0  
..... **\$473.25 PR** ⚠
- 36841771** ..... **51-54**  
1951-54 Chevy truck. Complete kit with chrome or black switches. Includes kit for vent window removal conversion. 16.180 -0  
..... **\$579.00 PR** ⚠
- PWCHEVT551** ..... **55-59**  
Chevy truck power window conversion kit, bolt in -0.15  
..... **\$747.00 PR** ⚠
- PWCHEVT601** ..... **60-63**  
Chevy truck power window conversion, bolt in -0  
..... **\$474.00 PR** ⚠

**Gear Driven Power Window Kits  
Ford Cars**

Power window conversion directly bolts into original mounting holes (except kits to remove vent windows), 1018 cold rolled steel, brass oilite thrust bearings, gear teeth treated for long life (cryogenics), delco OEM motors. Includes delco OEM chrome or illuminated switches, conduit for wiring and carries a lifetime warranty.

1937-39 FORD SHOWN



- PWFORD371** ..... **37-39**  
Ford 2DR coupe power window conversion. Bolt in, front doors only -0  
..... **\$608.00 PR** ⚠
- PWFORD372** ..... **37-39**  
Ford 2DR sedan power window conversion. Bolt in, front doors only -0  
..... **\$608.00 PR** ⚠
- PWFORD373** ..... **37-39**  
Ford 2DR sedan power window conversion. Front doors and rear quarters, bolt in -0  
..... **\$1,071.00 SET** ⚠
- PWFORD374** ..... **37-39**  
Ford 4DR sedan power window conversion. Bolt in, front doors only -0  
..... **\$608.00 PR** ⚠
- PWFORD401** ..... **40**  
Ford 2DR coupe, sedan delivery & 4DR front. power window conversion. bolt in, front doors only -0  
..... **\$474.00 PR** ⚠
- PWFORD402** ..... **40**  
Ford 2DR coupe, sedan delivery & 4DR front, power window conversion. Front doors only, for removed vent windows. Modification required -0  
..... **\$627.00 PR** ⚠
- PWFORD403** ..... **40**  
Ford 2DR sedan power window conversion. Bolt in, front doors only -0  
..... **\$474.00 PR** ⚠
- PWFORD404** ..... **40**  
Ford 4DR sedan power window conversion. Bolt in, front & rear doors -0  
..... **\$974.00 SET** ⚠
- PWFORD405** ..... **40**  
Ford 2DR sedan power window conversion. Front doors only for removed vent window. Modification required -0  
..... **\$627.00 PT** ⚠

**Gear Driven Power Window Kits  
Ford Cars, cont.**

- PWFORD406** ..... **40**  
Ford 2DR sedan power window conversion. Bolt in, front doors and rear quarters -0  
..... **\$1,129.00 SET** ⚠
- PWFORD411** ..... **41-48**  
Ford 2DR sedan power window conversion. Bolt in, front doors only -0  
..... **\$474.00 PR** ⚠
- PWFORD412** ..... **41-48**  
Ford 2DR sedan power window conversion. Bolt in, front & rear quarters -0  
..... **\$974.00 SET** ⚠
- PWFORD413** ..... **41-48**  
Ford 2DR sedan power window conversion. Front doors only, for removed vent window. Modification required -0  
..... **\$627.00 PR** ⚠
- PWFORD414** ..... **41-48**  
Ford 2DR sedan power window conversion. Front doors & rear quarters, for removed vent window. Modification required -0  
..... **\$1,129.00 SET** ⚠
- PWFORD415** ..... **41-48**  
Ford 2DR convertible power window conversion. Bolt in, front doors only -0  
..... **\$474.00 PR** ⚠
- PWFORD416** ..... **41-48**  
Ford 2DR coupe (long door) power window conversion. Bolt in, front doors only -0  
..... **\$474.00 PR** ⚠
- PWFORD417** ..... **41-48**  
Ford 2DR coupe (long door) power window conversion. Front doors only, for removed vent windows. Modification required -0  
..... **\$627.00 PR** ⚠
- PWFORD418** ..... **41-48**  
Ford 2DR coupe (short door) power window conversion. Bolt in, front doors only -0  
..... **\$474.00 PR** ⚠
- PWFORD419** ..... **41-48**  
Ford 2DR coupe (short door) Power Window Conversion. Front doors only, for removed vent windows. Modification required -0  
..... **\$627.00 PR** ⚠
- PWFORD421** ..... **42-48**  
Ford 2DR convertible power window conversion. Bolt in, front doors & quarter windows -0  
..... **\$1,353.00 SET** ⚠
- PWFORD491** ..... **49-51**  
Ford 2DR sedan & coupe power window conversion. Bolt in, front doors only -0  
..... **\$474.00 PR** ⚠

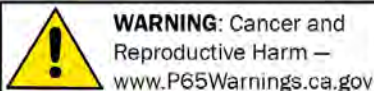

NOTE: Any chemicals will be shipped domestic ground only (Lower 48 states only). No international shipping.

**Gear Driven Power Window Kits  
Ford Cars, cont.**

<b>PWFORD493</b> .....	<b>49-51</b>
Ford 2DR convertible power window conversion. Bolt in, front doors only -0	
.....	<b>\$474.00 PR</b> ⚠
<b>PWFORD494</b> .....	<b>49-51</b>
Ford 2DR convertible power window conversion. Bolt in, front doors & quarter windows -0	
.....	<b>\$1,353.00 EA</b> ⚠
<b>PWFORD495</b> .....	<b>49-51</b>
Ford woody power window conversion. Bolt in, front doors only -0	
.....	<b>\$474.00 EA</b> ⚠
<b>PWFORD521</b> .....	<b>52-54</b>
Ford 2DR hardtop, sedan & convertible power window conversion. Bolt in, front doors only -0	
.....	<b>\$474.00 EA</b> ⚠
<b>PWFORD522</b> .....	<b>52-54</b>
Ford 2DR hardtop & convertible power window conversion. Bolt in, front doors & rear quarter windows -0	
.....	<b>\$970.00 EA</b> ⚠
<b>PWFORD551</b> .....	<b>55</b>
Ford 2DR hardtop, sedan & convertible power window conversion. Bolt in, front doors only -0	
.....	<b>\$474.00 EA</b> ⚠
<b>PWFORD552</b> .....	<b>55</b>
Ford 2DR Victoria & Crown Victoria power window conversion. Bolt in, front doors & rear quarter windows -0	
.....	<b>\$970.00 EA</b> ⚠
<b>PWFORD554</b> .....	<b>55</b>
Ford 2DR convertible power window conversion. Bolt in, front doors & quarter windows -0	
.....	<b>\$970.00 EA</b> ⚠
<b>PWFORD555</b> .....	<b>55-57</b>
Ford T-Bird power window conversion. Bolt in, front doors only -0	
.....	<b>\$522.00 EA</b> ⚠
<b>PWFORD561</b> .....	<b>56</b>
Ford 2DR hardtop, sedan & convertible power window conversion. Bolt in, front doors only -0	
.....	<b>\$474.00 EA</b> ⚠
<b>PWFORD563</b> .....	<b>56</b>
Ford convertible power window conversion. Bolt in, front doors & rear quarter windows -0	
.....	<b>\$970.00 EA</b> ⚠
<b>PWFORD564</b> .....	<b>56</b>
Ford 2DR Victoria & Crown Victoria power window conversion. Bolt in, front doors & rear quarter windows -0	
.....	<b>\$970.00 EA</b> ⚠

**Gear Driven Power Window Kits  
Ford Cars, cont.**

<b>PWFORD571</b> .....	<b>57-58</b>
Ford 2DR hardtop, sedan & convertible power window conversion. Bolt in, front doors only -0	
.....	<b>\$474.00 EA</b> ⚠
<b>PWFORD572</b> .....	<b>57-58</b>
Ford 2DR hardtop power window conversion. Bolt in, front doors & quarter windows -0	
.....	<b>\$970.00 EA</b> ⚠
<b>PWFORD573</b> .....	<b>57-58</b>
Ford 2DR retractable power window conversion. Bolt in, front doors & quarter windows -0	
.....	<b>\$970.00 EA</b> ⚠
<b>PWFORD574</b> .....	<b>57-58</b>
Ford 2DR convertible power window conversion. Bolt in, front doors & quarter windows -0	
.....	<b>\$970.00 EA</b> ⚠
<b>PWFORD575</b> .....	<b>57-58</b>
Ford 2DR Ranchero power window conversion. Bolt in, front doors only -0	
.....	<b>\$474.00 EA</b> ⚠
<b>PWFORD591</b> .....	<b>59</b>
Ford 2DR hardtop, sedan & convertible power window conversion. Bolt in, front doors only -0	
.....	<b>\$522.00 EA</b> ⚠
<b>PWFORD592</b> .....	<b>59</b>
Ford 2DR hardtop power window conversion. Bolt in, front doors & quarter windows -0	
.....	<b>\$970.00 EA</b> ⚠
<b>PWFORD593</b> .....	<b>59</b>
Ford 2DR retractable power window conversion. Bolt in, front doors & quarter windows -0	
.....	<b>\$970.00 EA</b> ⚠
<b>PWFORD594</b> .....	<b>59</b>
Ford 2DR convertible power window conversion. Bolt in, front doors & quarter windows -0	
.....	<b>\$970.00 EA</b> ⚠
<b>PWFORD602</b> .....	<b>60-64</b>
Ford 2DR hardtop, sedan & convertible power window conversion. Bolt in, front doors only -0	
.....	<b>\$522.00 EA</b> ⚠
<b>PWFORD603</b> .....	<b>60-64</b>
Ford 2DR hardtop power window conversion. Bolt in, front doors & quarter windows -0	
.....	<b>\$970.00 EA</b> ⚠
<b>PWFORD605</b> .....	<b>60-64</b>
Ford 2DR convertible power window conversion. Bolt in, front doors & quarter windows -0	
.....	<b>\$970.00 EA</b> ⚠

**Gear Driven Power Window Kits  
Ford Cars, cont.**

<b>PWFORD601</b> .....	<b>60-65</b>
Ford Falcon power window conversion. Bolt in, front doors only -0	
.....	<b>\$522.00 EA</b> ⚠

**Gear Driven Power Window Kits  
Ford Trucks**

Power window conversion directly bolts into original mounting holes (except kits to remove vent windows), 1018 cold rolled steel, brass oilite thrust bearings, gear teeth treated for long life (cryogenics), delco OEM motors. Includes delco OEM chrome or illuminated switches, conduit for wiring and carries a lifetime warranty.

<b>PWFORDT38</b> .....	<b>38-47</b>
Ford truck power window conversion. Bolt in -0	
.....	<b>\$608.00 EA</b> ⚠
<b>PWFORDT481</b> .....	<b>48-52</b>
Ford truck power window conversion. Bolt in -0	
.....	<b>\$474.00 EA</b> ⚠
<b>PWFORDT482</b> .....	<b>48-52</b>
Ford truck power window conversion. For vent window removal. Modification required -0	
.....	<b>\$627.00 EA</b> ⚠
<b>PWFORDT531</b> .....	<b>53-55</b>
Ford truck power window conversion. Bolt in -0	
.....	<b>\$474.00 EA</b> ⚠
<b>PWFORDT532</b> .....	<b>53-55</b>
Ford truck power window conversion. For vent window removal. Modification required -0	
.....	<b>\$627.00 EA</b> ⚠
<b>PWFORDT561</b> .....	<b>56</b>
Ford truck power window conversion. Bolt in -0	
.....	<b>\$474.00 EA</b> ⚠
<b>PWFORDT562</b> .....	<b>56</b>
Ford truck power window conversion. For vent window removal. Modification required -0	
.....	<b>\$627.00 EA</b> ⚠
<b>PWFORDT571</b> .....	<b>57-60</b>
Ford truck power window conversion. Bolt in -0	
.....	<b>\$474.00 EA</b> ⚠
<b>PWFORDT611</b> .....	<b>61-66</b>
Ford truck power window conversion. Bolt in -0	
.....	<b>\$474.00 EA</b> ⚠

Returns require a return authorization number—Please call first. · Note: Product pricing and availability subject to change.



**WARNING: Cancer and Reproductive Harm —**  
www.P65Warnings.ca.gov

**Window Crank Switch - Electric**



**NU-CRANKS11 . . . .ALL**  
Use your original crank handles as your switches. Ford 1948 & earlier, square shaft. Pair. -0.15

..... **\$220.00 PR** ⚠

**NU-CRANKS12 . . . . .ALL**

Use your original crank handles as your switches. GM 1949 & earlier, small round spline. Pair. -0.15

..... **\$220.00 PR** ⚠

**NU-CRANKS13 . . . . .ALL**

Use your original crank handles as your switches. GM 1950 & later, large round spline, long shaft. Pair. -0.15

..... **\$219.49 PR** ⚠

**NU-CRANKS14 . . . . .ALL**

Use your original crank handles as your switches. GM 1950 & later. Large round spline, short shaft. Pair. -0.15

..... **\$219.49 PR** ⚠

**NU-CRANKS15 . . . . .ALL**

Use your original crank handles as your switches. Ford 1949 & later, round spline. Pair. -0.15

..... **\$219.49 PR** ⚠

**NU-CRANKSU . . . . .ALL**

Use your original crank handles as your switches. Upgrade to power window kit only -0.15

..... **\$180.00 PR** ⚠

**Power Window Switch Kits -Oval Switches**

The following oval billet, 3-wire power window switches need a Reverse Polarity Module (#WASLO7-W) to function for power windows.

**WASL39B-CLIP . . . .ALL**  
Light Clip. Now you can add illumination to any of our family of L39B Power Window and specialty switches. This Clip secures to

the switch frame mounting screws and holds your choice of 5/32" size LED (sold separately). The LED shines between the billet rocker and face plate of the switch. We recommend using one clip each for Single or Double switches, use 2 on L39B04X 4-switch panel (you may use one Clip/LED per switch if you wish to achieve maximum illumination). -0.15

..... **\$5.00 EA** ⚠

**Power Window Switch Kits -Oval Switches, cont.**



**WASL39BCD . . . . .ALL**

Our Billet 3-wire rocker switches inside an attractive Billet Console Plate that's 2-1/4" wide by 2-1/2" high with brushed finish. †Add distinct styling in Billet to your custom console †2 switches, Console Plate, 2 polarity reversing modules, wire leads, connectors and instructions. -0.15

..... **\$139.00 SET** ⚠

**WASL39B0D . . . . .ALL**

Dual switch kit for center console mounting or for both switches on the driver door only. Dual switch frame is 3-1/8" wide by 1-5/8" high, (2) polarity reversing modules, wire leads and instructions. -0.15

..... **\$139.25 SET** ⚠



**WASL39B0T . . . . .ALL**

Oval. Triple kit puts dual switches on the driver door and one on the passenger door. Switches and frames, (2) polarity reversing modules, lots of wire and instructions. -0.15

..... **\$199.00 SET** ⚠

**WASL39BS . . . . .ALL**

You asked for them... and here they are! Billet, round-end, 3-wire rocker switch sits inside a billet frame that's just 1-1/8" wide by 1-3/4" high. This switch adapts directly to positive (+) output remote controls with no additional relays required! Single switch and frame, polarity reversing module, wire leads and instructions. -0.15

..... **\$78.00 EA** ⚠

**Power Window Switch Kits -Oval Switches, cont.**



**WASL39BT . . . . .ALL**

The 3 switch kit puts dual switches on the driver door and one on the passenger door. Switches and frames, (2) polarity reversing modules, lots of wire and instructions. -0.15

..... **\$199.25 SET** ⚠

**Modular Door Contacts**



**SDXB . . . . .ALL**

Bottom set of modular contacts for door jam electrical connections.

10.783 -0.15

..... **\$7.50 PR** ⚠

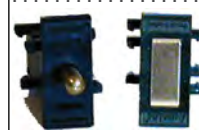

**SDXM . . . . .ALL**

Middle set of modular contacts for door jam electrical connections.

10.783 -0.15

..... **\$7.50 PR** ⚠



**SDXT . . . . .ALL**

Top set of modular contacts for door jam electrical connections.

10.783 -0.15

..... **\$7.50 PR** ⚠

**Window & Vent Cranks (Billet Specialties)**



**BIS47525BLK . . . . .ALL**

Ball milled billet aluminum vent window cranks. GM/Ford 1949 & up. Black anodized -0.15

..... **\$92.00 PR** ⚠



**BIS46525BLK . . . . .ALL**

Ball milled billet aluminum window cranks. GM/Ford 1949 & up. Black anodized -0.15

..... **\$92.00 PR** ⚠

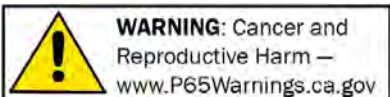

NOTE: Any chemicals will be shipped domestic ground only (Lower 48 states only). No international shipping.

**Custom Window & Vent Cranks (CMW Pro-Touring Series)**



**CMW-PT203** .....ALL  
-0.15 ..... \$125.09 L&R ⚠

**Custom Window & Vent Cranks (Paul Atkins Signature Series)**



**CMW-PT103** .....ALL  
-0.15 ..... \$92.39 L&R ⚠



**CMW-PT104** .....ALL  
-0.15 ..... \$92.39 L&R ⚠

**Custom Window & Vent Cranks (Trique Manufacturing)**



**TRQ-VWL05E** .....37-48  
Billet aluminum Banjo style crank fits vehicles from 1937 up to 1948. Polished. 10.664 -0.15 ..... \$130.25 PR ⚠



**TRQ-WL05E** .....37-48  
Billet window crank fits vehicles GM up to 1948. Polished. -0.15 ..... \$130.25 PR ⚠

**Custom Window & Vent Cranks (Trique Manufacturing), cont.**



**TRQ-VWL05L** .....49-54  
Billet aluminum Banjo style crank fits vehicles 1949 up. Polished. 10.664 -0.15 ..... \$130.09 PR ⚠



**TRQ-WL05L** .....49-54  
Billet window crank fits vehicles 1949 thru 1954. Polished. 10.797 -0.15 ..... \$130.09 PR ⚠

**Billet Window & Vent Cranks (Billet Specialties)**

Choose from 3 designs with steel spline inserts and dual set-screw locking system to ensure a secure fit with easy installation. Ultra high polish finish will set your ride off in style! For matching Door Handles see section 380.



**BIS46420** .....37-48  
Billet window crank fits vehicles 1937 thru 1948. Polished. 10.797 -0.15 ..... \$80.00 PR ⚠



**BIS47420** .....37-48  
Billet aluminum crank fits vehicles from 1937 up to 1948. Polished. 10.664 -0.15 ..... \$80.00 PR ⚠

**Billet Window & Vent Cranks (Billet Specialties), cont.**



**BIS47520** .....49-54  
Billet aluminum crank fits vehicles from 1949 on up. Polished. 10.664 -0.15 ..... \$80.00 PR ⚠



**BIS46325** .....ALL  
Ball milled billet aluminum window cranks. Ford to 1948. -0.15 ..... \$80.00 PR ⚠



**BIS46328** .....ALL  
Rail design. Billet aluminum window cranks. Ford to 1948. -0.15 ..... \$95.00 PR ⚠



**BIS46425** .....ALL  
Ball milled billet aluminum window cranks. GM to 1948. -0.15 ..... \$80.00 PR ⚠



**BIS46428** .....ALL  
Profile Series "rail" billet aluminum window cranks. GM to 1948. -0.15 ..... \$95.00 PR ⚠

**Billet Window & Vent Cranks (Billet Specialties), cont.**



**BIS47325**.....**.ALL**  
Ball milled billet aluminum vent window cranks. Ford to 1948. -0.15  
..... **\$80.00 PR** ⚠



**BIS47328**.....**.ALL**  
Profile Series "Rail" Billet aluminum vent window cranks. Ford to 1948. -0.15  
..... **\$95.00 PR** ⚠



**BIS47425**.....**.ALL**  
Ball milled billet aluminum vent window cranks. GM to 1948. -0.15  
..... **\$80.00 PR** ⚠



**BIS47428**.....**.ALL**  
Profile Series "Rail" Billet aluminum vent window cranks. GM to 1948. -0.15  
..... **\$95.00 PR** ⚠



**BIS47525**.....**.ALL**  
Ball milled billet aluminum vent window cranks. GM/Ford 1949 & up. -0.15  
..... **\$80.00 PR** ⚠

**Billet Window & Vent Cranks (Billet Specialties), cont.**



**BIS47528**.....**.ALL**  
Profile Series "Rail" Billet aluminum vent window cranks. GM/Ford 1949 & up. -0.15  
..... **\$95.00 PR** ⚠



**BIS46520**.....**.49-54**  
Billet window crank fits vehicles 1949 thru 1954. Polished. 10.797 -0.15  
..... **\$80.00 PR** ⚠



**BIS46525**.....**.ALL**  
Ball milled billet aluminum window cranks. GM/Ford 1949 & up. -0.15  
..... **\$80.00 PR** ⚠



**BIS46528**.....**.ALL**  
Profile Series "Rail" billet aluminum window cranks. GM/Ford 1949 & up. -0.15  
..... **\$95.00 PR** ⚠

**Window Cranks**

Featuring 4 distinct and stylish designs, these billet window cranks replace or upgrade your current window cranks to the high-end look of billet! Use them for manual setups or in conjunction with an Electric Window Switch (#EWS) to control your power windows. For matching Door Handles refer to section 380.



**BWC1**.....**.ALL**  
Open design. -0.15  
..... **\$61.49 PR** ⚠



**BWC2**.....**.ALL**  
Maltese Cross design. -0.15  
..... **\$60.00 PR** ⚠



**BWC3**.....**.ALL**  
Flame design. -0.15  
..... **\$61.49 PR** ⚠



**BWC4**.....**.ALL**  
Star design. -0.15  
..... **\$61.50 PR** ⚠



**IDH-2030**.....**.ALL**  
Ball milled billet aluminum window cranks. GM to 1948. -0.15  
..... **\$93.00 PR** ⚠

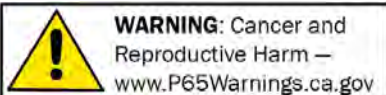

NOTE: Any chemicals will be shipped domestic ground only (Lower 48 states only). No international shipping.

# ADD COLOR AND STYLE TO YOUR TRUCK BED WITH **EXOTIC AND DOMESTIC BED WOODS!!**

Kiln-dried and stabilized. Properly milled, sanded and ready to finish.

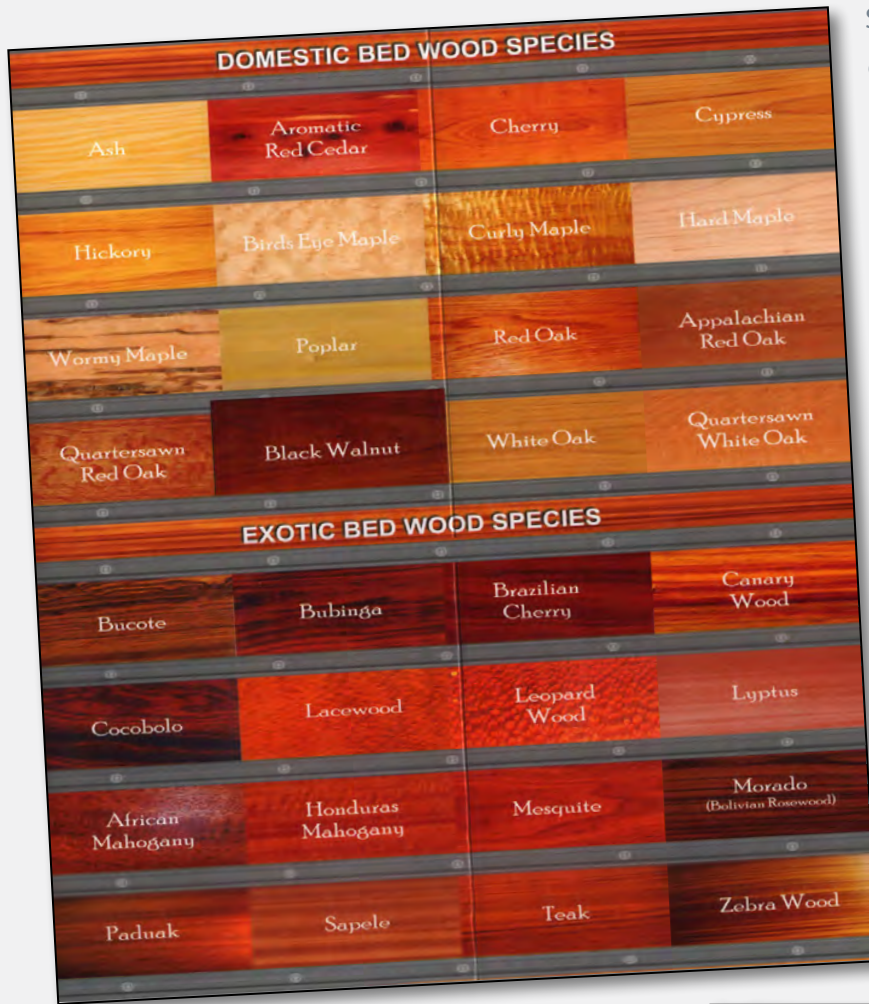

Sets are **milled to order** using only kiln dried "better than cabinet grade" lumber to assure you receive only the **highest quality product**. All pieces are 3/4" thick, grooved and trimmed to length. **Sanded** using a multi-step process providing a uniform and **extremely smooth surface**, ready to finish right out of the box. (Does not come stained or with final finish.) Boards individually numbered for ease of installation and chosen and matched based on color, character and grain. **Grooves available** to fit both OEM and Custom-style bed strips at **no extra charge**. Professional packaging to minimize potential damage during shipping. **Custom width and lengths** are available to meet your specific requirements. **Many other types of woods available**. Call for pricing.

part #	Short Beds		
BWP101	1937-39	6 boards	75-7/8"
BWP102	1940-45	6 boards	76-7/8"
BWP103	1946	7 boards	76-7/8"
BWP104	1947-51	9 boards	76-7/8"
BWP105	1951-54	8 boards	77-1/8"
Long Beds			
BWP109	1937-45	6 boards	85-7/8"
BWP111	1946	7 boards	85-7/8"
BWP112	1947-51	9 boards	85-13/16"
BWP113	1951-53	8 boards	85-13/16"
BWP114	1954	8 boards	89"
1 Ton			
BWP118	1947-51	8 boards	107"
BWP119	1952-54	8 boards	107"



Returns require a return authorization number—Please call first. · Note: Product pricing and availability subject to change.

# Section 490: Complete Bed & Bed Parts - Trunk & Trunk Lids

## Pros Pick Custom Beds

Fabricated from 16 gauge, satin coated steel (similar to galvanized)

Plug welded construction (no unsightly spot welds).

Epoxy primed so you can block sand and paint.

Includes 2 sides, closed stake pockets, front panel and all cross members.

\*Tailgate, bed strips and wood not included.

### Pros Pick Custom Beds - Chevy



'54-'55 (1st Series) Chevy Truck shown

**25230100** ..... **30-36**

Standard bed size and height. 20.000 -0.15

..... **\$1,475.00 SET** ⚠

**25237100** ..... **37-39**

Standard bed size and height. 20.000 -0.15

..... **\$1,476.49 SET** ⚠

**25240100** ..... **40-46**

Standard bed size and height. 20.000 -0.15

..... **\$1,476.49 EA** ⚠

**25247100** ..... **47-53**

Standard bed size and height. 20.000 -0.15

..... **\$1,475.00 EA** ⚠

**25247T100** ..... **47-53**

3 inch taller height than standard.

20.000 -0.15 ..... **\$1,620.00 EA** ⚠

**25254100** ..... **54-55**

Standard bed size and height. Fits 1st

Series. 20.000 -0.15 .. **\$1,620.00 SET** ⚠

### Pros Pick Custom Beds - Ford



**25135100** ..... **35-36**

Standard bed size and height. 20.000 -0

..... **\$1,475.00 EA** ⚠

**25137100** ..... **37**

Standard bed size and height. 20.000 -0

..... **\$1,475.00 EA** ⚠

**25138100** ..... **38-41**

Standard bed size and height. 20.000 -0

..... **\$1,475.00 EA** ⚠

## Tailgates - Custom

Stock tailgates have exposed hinges that leak rusty water, chains that damage expensive paint. Tailgates manufactured from 16 gauge, satin coated steel. Hidden hinges concealed into the rear cross member. Hidden latch assemblies actuated by 2 small knobs on the inside of the tailgate. Includes nylon latch bolts and stainless steel strikers to assure smooth, quiet and rust free operation. Mounts to Pro's Pick Custom Beds as well as Stock Beds to add a clean custom look to your original bed.



**TAILGATEPRO** ..... **46-87**

Smooth, clean finish. Fits pro's pick and other stock beds. -0.15 .. **\$928.19 EA** ⚠

### Pros Pick Custom Roll Pan - Chevy



**01101500TL** ..... **47-53**

LED Tail Light for pro's pick roll pan.

Upgrade only. . 12V -0.15

..... **\$359.00 PR** ⚠



**23247100** ..... **47-53**

Bolt-on, smooth. 1-piece, 12ga. steel. Recess for license plate. Use with Pro's Pick tailgate only (order 4-piece roll pan for stock tailgates). -0.15 .. **\$450.00 EA** ⚠

### Pros Pick Custom Beds - Tailgate Option



**TAILGATEPRO** ..... **46-87**

Smooth, clean finish. Add-on option to complete Pros' Pick bed (also sold separately). Smooth, clean finish. -0.15

..... **\$850.89 EA** ⚠

## Steel Corrugated Bed Floor

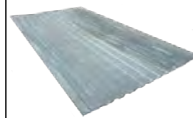

**3847403S** ..... **ALL**

Do you use your truck for work and don't want to ruin a nice wood floor? This steel

corrugated bed floor was designed for you. 80" long for short stepside beds. -0

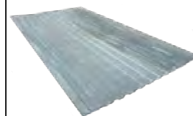

..... **\$750.00 EA** ⚠

**3847404S** ..... **ALL**

Do you use your truck for work and don't want to ruin a nice wood floor? This steel

corrugated bed floor was designed for you. 96" long for long stepside beds. -0

..... **\$950.00 EA** ⚠

### Tailgate - Hidden Latch

Stock tailgates are "beautiful", they hold the classic look that is near and dear to all enthusiasts. They also carry those tailgate chains that ruin our \$10,000 paint jobs.

Designed for easy install & tough, rust proof, rattle free operation. Includes check straps, not chains. A touch of the release buttons on each side allows the gate to open.



**26300016** ..... **ALL**

Latch kit with 16 inch straps. -0.15

..... **\$185.25 SET** ⚠

**26300021** ..... **ALL**

Latch kit with 21 inch straps. -0.15

..... **\$185.25 SET** ⚠



**WARNING:** Cancer and Reproductive Harm — [www.P65Warnings.ca.gov](http://www.P65Warnings.ca.gov)

NOTE: Any chemicals will be shipped domestic ground only (Lower 48 states only). No international shipping.

**(800) 952-1752 • www.streetrodhq.com**



**Power Tailgate Lift Kits**



**POWERGATE.....ALL**  
Electric power unit operates your tailgate either thru your remote or switch (included). 17.615 -0.15 .. **\$500.00 KIT** ⚠



**TG-1.....ALL**  
Open and close your tailgate at the touch of a button. Tough universal brackets and a heavy duty screw-type linear actuator provides up to 250 lb lifting capacity for the heaviest of tailgates. 17.600 -0.15  
..... **\$494.50 KIT** ⚠

**Tailgate Link Assembly**

**MAK102835.....41-53**  
Remove tailgate chains (modification to bed sides required). Includes instructions. 1941-53 -0.15 ..... **\$84.25 PR** ⚠



**MAK102835S.....41-53**  
Remove tailgate chains (modification to bed sides required). Includes instructions. Polished Stainless. 1941-53 -0.15  
..... **\$160.25 PR** ⚠

**MAK102834.....54-87**  
Remove tailgate chains (modification to bed sides required). Includes instructions. 1954-87 Stepside only. -0.15  
..... **\$84.25 PR** ⚠

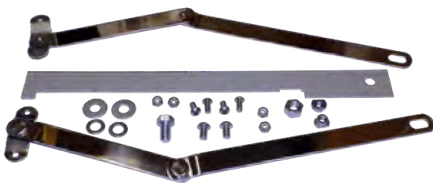

**MAK102834S.....54-87**  
Remove tailgate chains (modification to bed sides required). Includes instructions. Polished Stainless. 1954-87 Stepside only. -0.15 ..... **\$160.25 PR** ⚠

**Bed Lids**

Resin filled composite honeycomb for a durable, long lasting lid. Built-in stainless steel cross bar hinge laminated to the lid gives the hinge system strength and durability. Double stage locking system for extra security and dual heavy duty gas struts are mounted to assist in opening & closing the lid. Double weather seal helps protect cargo from the elements and protect bed rail from excessive wear and tear. Nylon pull strap to assist in closing. Cover reduces wind drag and saves fuel. Easy to install & remove. Primered finish with under lid charcoal carpeting. Bed lids for trucks not listed also available. Please call for email with your needs.



**BEDLID-TPC.....47-53**  
Primered finish. With carpet under lid. 17.499 -0.15 ..... **\$1,460.00 EA** ⚠

**BEDLID-TP.....54**  
Primered finish. 17.499 -0.15  
..... **\$1,300.00 EA** ⚠



**BEDLID-BPC.....54**  
Primered finish. With carpet under lid. 17.499 -0.15 ..... **\$1,450.00 EA** ⚠

**Bed Floor Covers**

**23292.....36-38**  
1936-1938 Dodge Utiline Showbedder Truck Bed Floor Cover Smooth -0.15  
..... **\$179.00 EA** ⚠

**23293.....36-38**  
1936-1938 Dodge Utiline Showbedder Truck Bed Floor Cover with M-025 Dodge Wing -0.15 ..... **\$209.00 EA** ⚠

**23312.....37**  
1937-1937 Ford Sedan Delivery Showbedder Truck Bed Floor Cover-Smooth -0.15 ..... **\$179.00 EA** ⚠

**23313.....37**  
1937-1937 Ford Sedan Delivery Showbedder Truck Bed Floor Cover with-F-001 Ford Script -0.15  
..... **\$209.00 EA** ⚠

**23270.....37-39**  
1937-1939 Chevrolet Truck Showbedder Bed Floor Cover Smooth -0.15  
..... **\$179.00 EA** ⚠

**Bed Floor Covers, cont.**

**23271.....37-39**  
1937-1939 Chevrolet Truck Showbedder Bed Floor Cover with G-009 Chev Bowtie -0.15 ..... **\$209.00 EA** ⚠

**23356.....37-39**  
1937-1939 GMC Truck Showbedder Bed Floor Cover Smooth -0.15  
..... **\$179.00 EA** ⚠

**23357.....37-39**  
1937-1939 GMC Truck Showbedder Bed Floor Cover with G-001 GMC -0.15  
..... **\$209.00 EA** ⚠

**23314.....38-39**  
1938-1939 Ford Sedan Delivery Showbedder Truck Bed Floor Cover-Smooth -0.15 ..... **\$179.00 EA** ⚠

**23315.....38-39**  
1938-1939 Ford Sedan Delivery Showbedder Truck Bed Floor Cover with-F-001 Ford Script -0.15  
..... **\$209.00 EA** ⚠

**23316.....38-41**  
1938-1941 Ford Showbedder Truck Bed Floor Cover-Smooth -0.15  
..... **\$179.00 EA** ⚠

**23317.....38-41**  
1938-1941 Ford Showbedder Truck Bed Floor Cover with-F-001 Ford Script -0.15  
..... **\$209.00 EA** ⚠

**23318.....39-40**  
1939-1940 Ford Sedan Delivery Showbedder Truck Bed Floor Cover-Smooth -0.15 ..... **\$179.00 EA** ⚠

**23319.....39-40**  
1939-1940 Ford Sedan Delivery Showbedder Truck Bed Floor Cover with-F-001 Ford Script -0.15  
..... **\$209.00 EA** ⚠

**23374.....39-40**  
1939-1940 Willys Truck Showbedder Bed Floor Cover Smooth -0.15  
..... **\$209.00 EA** ⚠

**23375.....39-40**  
1939-1940 Willys Truck Showbedder Bed Floor Cover-with J-080 Willys -0.15  
..... **\$209.00 EA** ⚠

**23376.....39-40**  
1939-1940 Willys Truck Showbedder Bed Floor Cover-with J-082 Willys W -0.15  
..... **\$209.00 EA** ⚠

**23294.....39-47**  
1939-1947 Dodge Utiline Showbedder Truck Bed Floor Cover Smooth -0.15  
..... **\$179.00 EA** ⚠

**23295.....39-47**  
1939-1947 Dodge Utiline Showbedder Truck Bed Floor Cover with M-095 Dodge -0.15 ..... **\$209.00 EA** ⚠



# Section 490: Complete Bed & Bed Parts - Trunk & Trunk Lids

## Bed Floor Covers, cont.

23272.....	40-46
1940-1946 Chevrolet Truck ShowBedder	
Bed Floor Cover Smooth -0.15	
.....	<b>\$179.00 EA</b> ⚠
23273.....	40-46
1940-1946 Chevrolet Truck ShowBedder	
Bed Floor Cover with G-009 Chev	
Bowtie -0.15 .....	<b>\$209.00 EA</b> ⚠
23358.....	40-46
1940-1946 GMC Truck Showbedder Bed	
Floor Cover Smooth -0.15	
.....	<b>\$179.00 EA</b> ⚠
23359.....	40-46
1940-1946 GMC Truck Showbedder Bed	
Floor Cover with G-001 GMC -0.15	
.....	<b>\$209.00 EA</b> ⚠
23320.....	41-48
1941-1948 Ford Sedan Delivery	
ShowBedder Truck Bed Floor Cover-	
Smooth -0.15 .....	
.....	<b>\$179.00 EA</b> ⚠
23321.....	41-48
1941-1948 Ford Sedan Delivery	
ShowBedder Truck Bed Floor Cover	
with-F-001 Ford Script -0.15	
.....	<b>\$209.00 EA</b> ⚠
23322.....	42-47
1942-1947 Ford ShowBedder Truck Bed	
Floor Cover-Smooth -0.15	
.....	<b>\$179.00 EA</b> ⚠
23323.....	42-47
1942-1947 Ford ShowBedder Truck Bed	
Floor Cover with-F-001 Ford Script -0.15	
.....	<b>\$209.00 EA</b> ⚠
23377.....	46-64
1946-1964 Willys Panel Delivery/Station	
Wagon ShowBedder Bed Floor Cover	
Smooth -0.15 .....	
.....	<b>\$179.00 EA</b> ⚠
23378.....	46-64
1946-1964 Willys Panel Delivery/Station	
Wagon ShowBedder Bed Floor Cover-with	
J-080 Willys -0.15 .....	
.....	<b>\$209.00 EA</b> ⚠
23379.....	46-64
1946-1964 Willys Panel Delivery/Station	
Wagon ShowBedder Bed Floor Cover-with	
J-082 Willys W -0.15 ..	
.....	<b>\$209.00 EA</b> ⚠
23274.....	47-54
1947-1954 Chevrolet Panel Delivery/	
Suburban Truck ShowBedder Bed Floor	
Cover Smooth -0.15 ...	
.....	<b>\$179.00 EA</b> ⚠
23275.....	47-54
1947-1954 Chevrolet Panel Delivery/	
Suburban ShowBedder Bed Floor Cover	
with G-009 Bowtie -0.15	
.....	<b>\$209.00 EA</b> ⚠
23276.....	47-54
1947-1954 Chevrolet Truck ShowBedder	
Bed Floor Cover Smooth -0.15	
.....	<b>\$179.39 EA</b> ⚠

## Bed Floor Covers, cont.

23277.....	47-54
1947-1954 Chevrolet Truck ShowBedder	
Bed Floor Cover with G-009 Chev	
Bowtie -0.15 .....	<b>\$209.00 EA</b> ⚠
23360.....	47-54
1947-1954 GMC Panel Delivery/	
Suburban Truck ShowBedder Bed Floor	
Cover Smooth -0.15 ...	
.....	<b>\$179.00 EA</b> ⚠
23361.....	47-54
1947-1954 GMC Panel Delivery/	
Suburban Truck ShowBedder Bed Floor	
Cover with G-001 GMC -0.15	
.....	<b>\$209.00 EA</b> ⚠
23362.....	47-54
1947-1954 GMC Truck Showbedder Bed	
Floor Cover Smooth -0.15	
.....	<b>\$179.00 EA</b> ⚠
23363.....	47-54
1947-1954 GMC Truck Showbedder Bed	
Floor Cover with G-001 GMC -0.15	
.....	<b>\$209.00 EA</b> ⚠
23380.....	47-63
1947-1963 Willys Truck ShowBedder Bed	
Floor Cover Smooth -0.15	
.....	<b>\$179.00 EA</b> ⚠
23381.....	47-63
1947-1963 Willys Truck ShowBedder Bed	
Floor Cover-with J-080 Willys -0.15	
.....	<b>\$209.00 EA</b> ⚠
23382.....	47-63
1947-1963 Willys Truck ShowBedder Bed	
Floor Cover-with J-082 Willys W -0.15	
.....	<b>\$209.00 EA</b> ⚠
23296.....	47-68
1947-1968 Dodge Power Wagon	
ShowBedder Truck Bed Floor Cover	
Smooth -0.15 .....	
.....	<b>\$179.00 EA</b> ⚠
23297.....	47-68
1947-1968 Dodge Power Wagon	
ShowBedder Truck Bed Floor Cover with	
M-068 Power Wagon -0.15	
.....	<b>\$209.00 EA</b> ⚠
23298.....	48-49
1948-1949 Dodge B-1 Utiline	
Showbedder Truck Bed Floor Cover	
Smooth -0.15 .....	
.....	<b>\$179.00 EA</b> ⚠
23299.....	48-49
1948-1949 Dodge B-1 Utiline	
Showbedder Truck Bed Floor Cover with	
M-095 Dodge -0.15 ...	
.....	<b>\$209.00 EA</b> ⚠
23324.....	48-52
1948-1952 Ford ShowBedder Panel	
Delivery Truck Bed Floor Cover-	
Smooth -0.15 .....	
.....	<b>\$179.00 EA</b> ⚠
23325.....	48-52
1948-1952 Ford ShowBedder Panel	
Delivery Truck Bed Floor Cover with-F-001	
Ford Script -0.15 .....	
.....	<b>\$209.00 EA</b> ⚠

## Bed Floor Covers, cont.

23326.....	48-52
1948-1952 Ford ShowBedder Panel	
Delivery Truck Bed Floor Cover with-F-004	
Ford V-8 -0.15 .....	
.....	<b>\$209.00 EA</b> ⚠
23327.....	48-52
1948-1952 Ford ShowBedder Truck Bed	
Floor Cover with-F-001 Ford Script -0.15	
.....	<b>\$179.00 EA</b> ⚠
23328.....	48-52
1948-1952 Ford ShowBedder Truck Bed	
Floor Cover with-F-004 Ford V-8 -0.15	
.....	<b>\$209.00 EA</b> ⚠
23383.....	48-64
1948-1964 Willys Jeepster ShowBedder	
Bed Floor Cover Smooth -0.15	
.....	<b>\$179.00 EA</b> ⚠
23384.....	48-64
1948-1964 Willys Jeepster ShowBedder	
Bed Floor Cover-with J-080 Willys -0.15	
.....	<b>\$209.00 EA</b> ⚠
23385.....	48-64
1948-1964 Willys Jeepster ShowBedder	
Bed Floor Cover-with J-082 Willys W -0.15	
.....	<b>\$209.00 EA</b> ⚠
23300.....	50-52
1950-1952 Dodge B-2/3 Utiline	
Showbedder Truck Bed Floor Cover	
Smooth -0.15 .....	
.....	<b>\$179.00 EA</b> ⚠
23301.....	50-52
1950-1952 Dodge B-2/3 Utiline	
Showbedder Truck Bed Floor Cover with	
M-095 Dodge -0.15 ...	
.....	<b>\$209.00 EA</b> ⚠
23329.....	53-56
1953-1956 Ford ShowBedder Panel	
Delivery Truck Bed Floor Cover-	
Smooth -0.15 .....	
.....	<b>\$179.00 EA</b> ⚠
23330.....	53-56
1953-1956 Ford ShowBedder Panel	
Delivery Truck Bed Floor Cover with-F-001	
Ford Script -0.15 .....	
.....	<b>\$209.00 EA</b> ⚠
23331.....	53-56
1953-1956 Ford ShowBedder Panel	
Delivery Truck Bed Floor Cover with-F-004	
Ford V-8 -0.15 .....	
.....	<b>\$209.00 EA</b> ⚠
23332.....	53-56
1953-1956 Ford ShowBedder Panel	
Delivery Truck Bed Floor Cover with-F-044	
Ford F-100 -0.15 .....	
.....	<b>\$209.00 EA</b> ⚠
23333.....	53-56
1953-1956 Ford ShowBedder Truck Bed	
Floor Cover-Smooth -0.15	
.....	<b>\$179.00 EA</b> ⚠
23334.....	53-56
1953-1956 Ford ShowBedder Truck Bed	
Floor Cover with-F-001 Ford Script -0.15	
.....	<b>\$209.00 EA</b> ⚠
23335.....	53-56
1953-1956 Ford ShowBedder Truck Bed	
Floor Cover with-F-004 Ford V-8 -0.15	
.....	<b>\$209.00 EA</b> ⚠

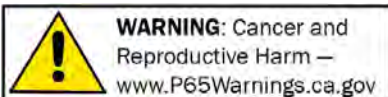

NOTE: Any chemicals will be shipped domestic ground only (Lower 48 states only). No international shipping.

**(800) 952-1752 • www.streetrodhq.com**

# Section 490: Complete Bed & Bed Parts - Trunk & Trunk Lids

## Bed Floor Covers, cont.

23336.....	53-56
1953-1956 Ford ShowBedder Truck Bed Floor Cover with-F-044 Ford F-100 -0.15	
.....	\$209.00 EA ⚠
23302.....	53-60
1953-1960 Dodge B-4/C1-3 Utiline Showbedder Truck Bed Floor Cover Smooth -0.15	
.....	\$179.00 EA ⚠
23303.....	53-60
1953-1960 Dodge B-4/C1-3 Utiline Showbedder Truck Bed Floor Cover with M-095 Dodge -0.15	
.....	\$209.00 EA ⚠
23278.....	55-58
1955-1958 Chevrolet Truck ShowBedder Bed Floor Cover with G-072 Cameo -0.15	
.....	\$209.00 EA ⚠
23279.....	55-59
1955-1959 Chevrolet Panel Delivery/ Suburban ShowBedder Bed Floor Cover Smooth -0.15	
.....	\$179.00 EA ⚠
23280.....	55-59
1955-1959 Chevrolet Panel Delivery/ Suburban ShowBedder Bed Floor Cover with G-009 Chev Bowtie -0.15	
.....	\$209.00 EA ⚠
23281.....	55-59
1955-1959 Chevrolet Truck ShowBedder Bed Floor Cover Smooth -0.15	
.....	\$179.00 EA ⚠
23282.....	55-59
1955-1959 Chevrolet Truck ShowBedder Bed Floor Cover with G-009 Chev Bowtie -0.15	
.....	\$209.00 EA ⚠
23283.....	55-59
1955-1959 Chevrolet Truck ShowBedder Bed Floor Cover with G-059 Apache 10 -0.15	
.....	\$209.00 EA ⚠
23364.....	55-59
1955-1959 GMC Panel Delivery/ Suburban Truck ShowBedder Bed Floor Cover Smooth -0.15	
.....	\$179.00 EA ⚠
23365.....	55-59
1955-1959 GMC Panel Delivery/ Suburban Truck ShowBedder Bed Floor Cover with G-001 GMC -0.15	
.....	\$209.00 EA ⚠
23366.....	55-59
1955-1959 GMC Truck ShowBedder Bed Floor Cover Smooth -0.15	
.....	\$179.00 EA ⚠
23367.....	55-59
1955-1959 GMC Truck ShowBedder Bed Floor Cover with G-001 GMC -0.15	
.....	\$209.00 EA ⚠
23337.....	57-58
1957-1958 Ford Ranchero ShowBedder Truck Bed Floor Cover-Smooth -0.15	
.....	\$179.00 EA ⚠

## Bed Floor Covers, cont.

23338.....	57-58
1957-1958 Ford Ranchero ShowBedder Truck Bed Floor Cover with-F-047 Ranchero Script -0.15	
.....	\$209.00 EA ⚠
23304.....	57-59
1957-1959 Dodge Sweptside Showbedder Truck Bed Floor Cover Smooth -0.15	
.....	\$179.00 EA ⚠
23305.....	57-59
1957-1959 Dodge Sweptside ShowBedder Truck Bed Floor Cover with M-062 Dodge 100 -0.15	
.....	\$209.00 EA ⚠
23339.....	57-60
1957-1960 Ford Styleside ShowBedder Truck Bed Floor Cover-Smooth -0.15	
.....	\$179.00 EA ⚠
23340.....	57-60
1957-1960 Ford Styleside ShowBedder Truck Bed Floor Cover with-F-003 Ford Oval -0.15	
.....	\$209.00 EA ⚠
23341.....	57-60
1957-1960 Ford Styleside ShowBedder Truck Bed Floor Cover with-F-005 Ford Block -0.15	
.....	\$209.00 EA ⚠
23342.....	57-60
1957-1960 Ford ShowBedder Panel Delivery Truck Bed Floor Cover-Smooth -0.15	
.....	\$179.00 EA ⚠
23343.....	57-60
1957-1960 Ford ShowBedder Panel Delivery Truck Bed Floor Cover with-F-003 Ford Oval -0.15	
.....	\$209.00 EA ⚠
23344.....	57-60
1957-1960 Ford ShowBedder Panel Delivery Truck Bed Floor Cover with-F-005 Ford Block -0.15	
.....	\$209.00 EA ⚠
23345.....	57-60
1957-1960 Ford Stepside ShowBedder Truck Bed Floor Cover-Smooth -0.15	
.....	\$179.00 EA ⚠
23346.....	57-60
1957-1960 Ford Stepside ShowBedder Truck Bed Floor Cover with-F-003 Ford Oval -0.15	
.....	\$209.00 EA ⚠
23347.....	57-60
1957-1960 Ford Stepside ShowBedder Truck Bed Floor Cover with-F-005 Ford Block -0.15	
.....	\$209.00 EA ⚠
23348.....	59
1959 Ford Ranchero ShowBedder Truck Bed Floor Cover-Smooth -0.15	
.....	\$179.00 EA ⚠
23349.....	59
1959 Ford Ranchero ShowBedder Truck Bed Floor Cover with-F-047 Ranchero Script -0.15	
.....	\$209.00 EA ⚠
23284.....	59-60
1959-1960 Chevrolet El Camino ShowBedder Truck Bed Floor Cover Smooth -0.15	
.....	\$179.39 EA ⚠

## Bed Floor Covers, cont.

23285.....	59-60
1959-1960 Chevrolet El Camino ShowBedder Truck Bed Floor Cover with G-003 El Camino Script -0.15	
.....	\$209.00 EA ⚠
23286.....	60-66
1960-1966 Chevrolet Fleetside Truck ShowBedder Bed Floor Cover Smooth -0.15	
.....	\$179.00 EA ⚠
23287.....	60-66
1960-1966 Chevrolet Fleetside Truck ShowBedder Bed Floor Cover with G-010 Chev Bowtie -0.15	
.....	\$209.00 EA ⚠
23288.....	60-66
1960-1966 Chevrolet Panel Delivery/ Suburban Truck ShowBedder Bed Floor Cover Smooth -0.15	
.....	\$179.00 EA ⚠
23289.....	60-66
1960-1966 Chevrolet Panel Delivery/ Suburban ShowBedder Bed Floor Cover with G010 Chev Bowtie -0.15	
.....	\$209.00 EA ⚠
23290.....	60-66
1960-1966 Chevrolet Stepside Truck ShowBedder Bed Floor Cover Smooth -0.15	
.....	\$179.00 EA ⚠
23291.....	60-66
1960-1966 Chevrolet Stepside ShowBedder Bed Floor Cover with G-010 Chev Bowtie -0.15	
.....	\$209.00 EA ⚠
23368.....	60-66
1960-1966 GMC Fleetside ShowBedder Truck Bed Floor Cover Smooth -0.15	
.....	\$179.00 EA ⚠
23369.....	60-66
1960-1966 GMC Fleetside ShowBedder Truck Bed Floor Cover with G-001 GMC -0.15	
.....	\$209.00 EA ⚠
23370.....	60-66
1960-1966 GMC ShowBedder Panel Delivery/Suburban Truck Bed Floor Cover Smooth -0.15	
.....	\$179.00 EA ⚠
23371.....	60-66
1960-1966 GMC ShowBedder Panel Delivery/Suburban Truck Bed Floor Cover with G-001 GMC -0.15	
.....	\$209.00 EA ⚠
23372.....	60-66
1960-1966 GMC Stepside ShowBedder Truck Bed Floor Cover Smooth -0.15	
.....	\$179.00 EA ⚠
23373.....	60-66
1960-1966 GMC Stepside ShowBedder Truck Bed Floor Cover with G-001 GMC -0.15	
.....	\$209.00 EA ⚠
23350.....	61-66
1961-1966 Ford Styleside ShowBedder Truck Bed Floor Cover-Smooth -0.15	
.....	\$179.00 EA ⚠

Returns require a return authorization number—Please call first. · Note: Product pricing and availability subject to change.



**WARNING:** Cancer and Reproductive Harm — [www.P65Warnings.ca.gov](http://www.P65Warnings.ca.gov)

**Bed Floor Covers, cont.**

- 23351..... 61-66  
1961-1966 Ford Styleside ShowBedder  
Truck Bed Floor Cover with-F-003 Ford  
Oval -0.15 ..... **\$209.00 EA** ⚠
- 23352..... 61-66  
1961-1966 Ford Styleside ShowBedder  
Truck Bed Floor Cover with-F-005 Ford  
Block -0.15 ..... **\$209.00 EA** ⚠
- 23353..... 61-66  
1961-1966 Ford Stepside ShowBedder  
Truck Bed Floor Cover-Smooth -0.15  
..... **\$179.00 EA** ⚠
- 23354..... 61-66  
1961-1966 Ford Stepside ShowBedder  
Truck Bed Floor Cover with-F-003 Ford  
Oval -0.15 ..... **\$209.00 EA** ⚠
- 23355..... 61-66  
1961-1966 Ford Stepside ShowBedder  
Truck Bed Floor Cover with-F-005 Ford  
Block -0.15 ..... **\$209.00 EA** ⚠
- 23306..... 61-71  
1961-1971 Dodge Sweptline ShowBedder  
Truck Bed Floor Cover Smooth -0.15  
..... **\$179.00 EA** ⚠
- 23307..... 61-71  
1961-1971 Dodge Sweptline ShowBedder  
Truck Bed Floor Cover with M-072  
Ram -0.15 ..... **\$209.00 EA** ⚠
- 23308..... 61-71  
1961-1971 Dodge Sweptline ShowBedder  
Truck Bed Floor Cover with M-075  
Dodge -0.15 ..... **\$209.00 EA** ⚠
- 23309..... 61-71  
1961-1971 Dodge Upline ShowBedder  
Truck Bed Floor Cover Smooth -0.15  
..... **\$179.00 EA** ⚠
- 23310..... 61-71  
1961-1971 Dodge Upline ShowBedder  
Truck Bed Floor Cover with M-072  
Ram -0.15 ..... **\$209.00 EA** ⚠
- 23311..... 61-71  
1961-1971 Dodge Upline ShowBedder  
Truck Bed Floor Cover with M-075 Dodge  
Text -0.15 ..... **\$209.00 EA** ⚠

**LED Bed Roll Light**



**LEDBEDLITE** .....ALL  
LED tail light w/  
Aluminum housing  
in 15/16" (red only),  
1-1/8", 1-1/4" or  
1-5/8" diameters.

Choose Amber or Red. 12V 0.000-0  
..... **\$110.00 PR** ⚠

**LEDBEDLITE-RET** ..ALL  
LED bed roll light  
retaining rings for flat  
panel installations  
(taillight not included,  
shown for display  
purposes only). 0.000-0.15

..... **\$20.99 PR** ⚠

**LED Bed Roll Light, cont.**



**MAK102864** .....ALL  
Red LEDs. Billet aluminum w/ polished  
bezel. Dual intensity for tail light and  
brake/ turn signal. Includes 10" pigtail.  
Fits 40-66 Chevy, 40-87 GMC. 12V.  
1-19/32 hole. 0.000-0

..... **\$148.00 PR** ⚠



**MAK102865** .....ALL  
19 Amber LEDs. 12V.  
1-19/32 hole. 0.000-0

..... **\$148.00 PR** ⚠



**MAK102866** .....ALL  
19 White LEDs for back up lights. 12V.  
1-19/32 hole. 0.000-0

..... **\$160.00 PR** ⚠

**Bed Roll Reflector**

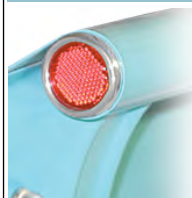

**MAK102850** .....41-66  
red insert reflector.  
0.000-0.15

..... **\$60.25 PR** ⚠

**Tail Light - Truck Bed**



**MAK102853** .....41-66  
Chevy - Red. Incandescent bulb (amber  
also available). 0.000-0

..... **\$86.00 PR** ⚠

**Billet Caps**



**466423B** .....37-39  
1-1/4in. polished  
aluminum w/ bowtie,  
covers hole in bed roll  
17.505-0

..... **\$56.00 PR** ⚠

**Billet Caps, cont.**



**3806518B** .....41-55  
1-19/32in. polished  
aluminum w/ bowtie,  
covers hole in bed roll  
17.505-0

..... **\$56.00 PR** ⚠



**3806518C** .....41-55  
1-19/32 in. brushed  
aluminum, covers hole  
in bed roll. 17.505-0

..... **\$43.00 PR** ⚠

**Stake Pocket Hole Covers**



**MAK2001190** ...ALL  
Paintable steel top,  
stainless base (2 pairs  
needed per bed). -0.15

..... **\$32.00 PR** ⚠

**Fuel Filler Concealment Kit**



**LHRSCK** .....ALL  
Hide your fill neck in the bed. Motor lifts a  
bed wood panel for easy access. All  
stainless & aluminum hardware, hinges,  
motor & switch included. 17.438-0

..... **\$650.25 SET** ⚠

**Fuel Fill Caps**



**GAS-CAP-STNLS** .....ALL  
Stainless steel, flush cap with retaining  
chain & key. 3.028-0.15

..... **\$37.00 EA** ⚠

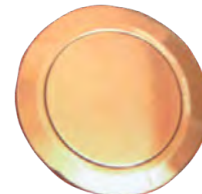

**KUSC-312521** .....ALL  
Polished Billet Aluminum. 2-1/2" dia. Twist  
to pop open. -0.15

..... **\$131.00 EA** ⚠

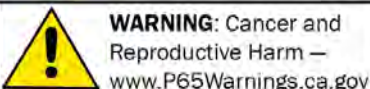

NOTE: Any chemicals will be shipped domestic ground only (Lower 48 states only). No international shipping.

**Fuel Fill Caps, cont.**



**TAIAIR** .....ALL  
 Polished Aluminum  
 Aircraft Style Gas Cap  
 and Neck  
 O-Ring Sealed  
 Stainless Chain

Tethered Fuel Cap

Cam Lock Cap is removed by twisting the center tab a quarter of a turn.

3-3/4" Diameter Outside Diameter Flange  
 2-5/8" Overall Length

5 Bolt Pattern 1/8" Thick Mounting Flange

2" OD Hose Connection

Mounting hardware included -0.15

..... **\$85.25 EA** ⚠



**TAITAC** .....ALL  
 Polished aluminum  
 vented cap 3-1/4"  
 diameter. 2-3/4" Bolt  
 Circle Filler Neck with a  
 3-1/4" Outer Flange  
 2" Long Filler Neck with

a 2" OD Hose Connection

Cap will stick up 5/8" when installed -0.15

..... **\$60.00 EA** ⚠

**Trunk Lids - Fiberglass, Chevy**

Note: Our fiberglass trunk lids are steel framed and assembled. Yet another example of our effort to provide the best products we can to our customers.

Note: Trunk lids are too large for UPS...sent freight collect. \$7 packaging fee.

**4083385** .....**37-38**  
 Sedan. 12.181 -0.15 .. **\$795.00 EA** ⚠  
**4083385F** .....**37-38**  
 Sedan, frenched license pocket.  
 12.181 -0.15

..... **\$795.00 EA** ⚠  
**4084781** .....**37-38**  
 Coupe. 12.181 -0.15 .. **\$725.00 EA** ⚠  
**4084781F** .....**37-38**  
 Coupe, frenched license pocket.  
 12.181 -0.15

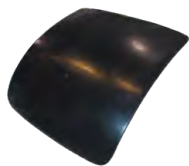

..... **\$795.00 EA** ⚠  
**4091434** ..... **39**  
 Coupe. 12.181 -0.15  
 ..... **\$795.00 EA** ⚠  
**4091434F** ..... **39**  
 Coupe, frenched license pocket.  
 12.181 -0.15

..... **\$815.00 EA** ⚠  
**4103252** ..... **40**  
 Coupe. 12.181 -0 .. **CALL** ⚠

**Trunk Lids - Fiberglass, Chevy, cont.**

**4103252F** ..... **40**  
 Coupe, frenched license pocket. 12.181 -0

..... **CALL** ⚠

**4113911** ..... **40**  
 Sedan. 12.181 -0 .. **CALL** ⚠

**4147955** ..... **41-48**  
 Coupe. 12.181 -0.15

..... **\$715.00 EA** ⚠  
**4147955F** ..... **41-48**

Coupe with frenched license pocket.  
 12.181 -0

..... **CALL** ⚠

**Under Trunk Insulation Covers - Chevrolet**

1955-56 CHEVY SHOWN

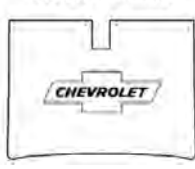

**22571** ..... **55-56**  
 1955-56 Chevrolet Under Trunk Cover  
 Kit-Smooth -0.15 .. **\$99.00** ⚠

**22572** ..... **55-56**  
 1955-56 Chevrolet Under Trunk Cover-  
 with G-010 Chev Bowtie AcoustiHood  
 Kit -0.15 .. **\$149.00** ⚠

**22573** ..... **55-56**  
 1955-56 Chevrolet Under Trunk Cover-  
 with G-016 Belair Wing AcoustiHood  
 Kit -0.15 .. **\$149.00** ⚠

**22574** ..... **55-56**  
 1955-56 Chevrolet Under Trunk Cover-  
 with G-066 Belair Crest AcoustiHood  
 Kit -0.15 .. **\$149.00** ⚠

**22575** ..... **55-56**  
 1955-56 Chevrolet Under Trunk Cover-  
 with G-082 Belair Script AcoustiHood  
 Kit -0.15 .. **\$149.00** ⚠

**22576** ..... **57**  
 1957 Chevrolet Under Trunk Cover  
 Kit-Smooth -0.15 .. **\$99.00** ⚠

**22577** ..... **57**  
 1957 Chevrolet Under Trunk Cover-with  
 G-010 Chev Bowtie AcoustiHood Kit -0.15 .. **\$149.00** ⚠

**22578** ..... **57**  
 1957 Chevrolet Under Trunk Cover-with  
 G-016 Belair Wing AcoustiHood Kit -0.15 .. **\$149.00** ⚠

**22579** ..... **57**  
 1957 Chevrolet Under Trunk Cover-with  
 G-082 Belair Script AcoustiHood Kit -0.15 .. **\$149.00** ⚠

**22580** ..... **58**  
 1958 Chevrolet Under Trunk Cover  
 Kit-Smooth -0.15 .. **\$99.00** ⚠

**Under Trunk Insulation Covers - Chevrolet, cont.**

**22581** ..... **58**  
 1958 Chevrolet Under Trunk Cover-with  
 G-010 Chev Bowtie AcoustiHood Kit -0.15

..... **\$149.00** ⚠

**22582** ..... **58**  
 1958 Chevrolet Under Trunk Cover-with  
 G-016 Bel Air AcoustiHood Kit -0.15

..... **\$149.00** ⚠

**22583** ..... **58**  
 1958 Chevrolet Under Trunk Cover-with  
 G-020 Chev Delray AcoustiHood Kit -0.15

..... **\$149.00** ⚠

**22584** ..... **58**  
 1958 Chevrolet Under Trunk Cover-with  
 G-082 Bel Air Script AcoustiHood Kit -0.15

..... **\$149.00** ⚠

**22585** ..... **58**  
 1958 Chevrolet Under Trunk Cover-with  
 G-121 Chev Biscayne AcoustiHood  
 Kit -0.15 .. **\$149.00** ⚠

**22586** ..... **59-60**  
 1959-60 Chevrolet Under Trunk Cover  
 Kit-Smooth -0.15 .. **\$99.00** ⚠

**22587** ..... **59-60**  
 1959-60 Chevrolet Under Trunk Cover-  
 with G-010 Chev Bowtie AcoustiHood  
 Kit -0.15 .. **\$149.00** ⚠

**22588** ..... **59-60**  
 1959-60 Chevrolet Under Trunk Cover-  
 with G-013 Chev Wing AcoustiHood  
 Kit -0.15 .. **\$149.00** ⚠

**22589** ..... **59-60**  
 1959-60 Chevrolet Under Trunk Cover-  
 with G-016 BelAir Wing AcoustiHood  
 Kit -0.15 .. **\$149.00** ⚠

**22590** ..... **59-60**  
 1959-60 Chevrolet Under Trunk Cover-  
 with G-042 Impala Script AcoustiHood  
 Kit -0.15 .. **\$149.00** ⚠

**22591** ..... **61-62**  
 1961-62 Chevrolet Car Under Trunk Cover  
 Kit-Smooth -0.15 .. **\$99.00** ⚠

**22592** ..... **61-62**  
 1961-62 Chevrolet Car Under Trunk  
 Cover-with G-010 Chev Bowtie  
 AcoustiHood Kit -0.15 .. **\$149.00** ⚠

**22593** ..... **61-62**  
 1961-62 Chevrolet Car Under Trunk  
 Cover-with G-013 Chev Wing AcoustiHood  
 Kit -0.15 .. **\$149.00** ⚠

**22594** ..... **61-62**  
 1961-62 Chevrolet Car Under Trunk  
 Cover-with G-016 BelAir Wing AcoustiHood  
 Kit -0.15 .. **\$149.00** ⚠

**22595** ..... **61-62**  
 1961-62 Chevrolet Car Under Trunk  
 Cover-with G-042 Impala Script  
 AcoustiHood Kit -0.15 .. **\$149.00** ⚠

**22596** ..... **63-64**  
 1963-64 Chevrolet Under Trunk Cover  
 Kit-Smooth -0.15 .. **\$99.00** ⚠



**Under Trunk Insulation Covers - Chevrolet, cont.**

22597.....	63-64
1963-64 Chevrolet Under Trunk Cover-with G-010 Chev Bowtie AcoustiHood Kit -0.15 ..... \$149.00 ⚠	
22598.....	63-64
1963-64 Chevrolet Under Trunk Cover-with G-013 Chev Wing AcoustiHood Kit -0.15 ..... \$149.00 ⚠	
22599.....	63-64
1963-64 Chevrolet Under Trunk Cover-with G-016 BelAir Wing AcoustiHood Kit -0.15 ..... \$149.00 ⚠	
22600.....	63-64
1963-64 Chevrolet Under Trunk Cover-with G-042 Impala AcoustiHood Kit -0.15 ..... \$149.00 ⚠	

**Under Insulation Trunk Covers - Ford**

1962-65 FAIRLANE SHOWN



22605.....	57
1957 Ford Under Trunk Retractable Cover-Smooth -0.15 ..... \$129.00 ⚠	
22606.....	57
1957 Ford Under Trunk Retractable Cover-with F-045 Ford Fairlane 500 -0.15 ..... \$169.00 ⚠	
22607.....	57
1957 Ford Under Trunk Cover-Smooth -0.15 ..... \$99.00 ⚠	
22608.....	57
1957 Ford Under Trunk Cover-with F-045 Ford Fairlane 500 -0.15 .. \$149.00 ⚠	
22609.....	58
1958 Ford Under Trunk Retractable Cover-Smooth -0.15 ..... \$129.00 ⚠	
22610.....	58
1958 Ford Under Trunk Retractable Cover-with F-045 Ford Fairlane 500 -0.15 ..... \$149.00 ⚠	
22611.....	58
-0.15 ..... \$99.00 ⚠	
22612.....	58
-0.15 ..... \$149.00 ⚠	
22613.....	59
1959 Ford Under Trunk Cover Kit-Smooth -0.15 ..... \$99.00 ⚠	
22614.....	59
1959 Ford Under Trunk Cover-with F-045 Ford Fairlane AcoustiHood Kit -0.15 ..... \$149.00 ⚠	
22615.....	59
1959 Ford Under Trunk Cover-with F-076 Ford Galaxie AcoustiHood Kit -0.15 ..... \$149.00 ⚠	

**Under Insulation Trunk Covers - Ford, cont.**

22616.....	60-62
1960-62 Ford Under Trunk Cover Kit-Smooth -0.15 ..... \$99.00 ⚠	
22617.....	60-62
1960-62 Ford Under Trunk Cover-with F-065 Galaxie Crest AcoustiHood Kit -0.15 ..... \$149.00 ⚠	
22603.....	60-63
1960-63 Falcon Under Trunk Cover Kit-Smooth -0.15 ..... \$99.00 ⚠	
22604.....	60-63
1960-63 Falcon Under Trunk Cover-with F-053 Futura Script AcoustiHood Kit -0.15 ..... \$149.00 ⚠	
22601.....	62-65
1962-65 Fairlane Under Trunk Cover-Smooth AcoustiHood Kit -0.15 ..... \$99.00 ⚠	
22602.....	62-65
1962-65 Fairlane Under Trunk Cover-with F-045 Fairlane 500 AcoustiHood Kit -0.15 ..... \$149.00 ⚠	
22618.....	63-64
1963-64 Ford Under Trunk Cover Kit-Smooth -0.15 ..... \$99.00 ⚠	
22619.....	63-64
1963-64 Ford Under Trunk Cover-with F-065 Galaxie Crest AcoustiHood Kit -0.15 ..... \$149.00 ⚠	

**Under Trunk Insulation Covers - Mercury**

22620.....	49-51
1949-51 Mercury Under Trunk Cover-Smooth -0.15 ..... \$169.00 ⚠	
22621.....	49-51
1949-51 Mercury Under Trunk Cover-with F-077 Mercury iMî -0.15 ..... \$239.00 ⚠	
22622.....	52-54
1952-54 Mercury Under Trunk Cover-Smooth -0.15 ..... \$169.00 ⚠	
22623.....	52-54
1952-54 Mercury Under Trunk Cover-with F-077 Mercury iMî -0.15 ..... \$239.00 ⚠	
22624.....	55-56
1955-56 Mercury Under Trunk Cover-Smooth -0.15 ..... \$169.00 ⚠	
22625.....	55-56
1955-56 Mercury Under Trunk Cover-with F-077 Mercury iMî -0.15 ..... \$239.00 ⚠	

**Under Trunk Insulation Covers - Oldsmobile**

22626.....	50
1950 Oldsmobile Under Trunk Cover Kit-Smooth -0.15 ..... \$103.00 ⚠	

**Trunk Hinge Kit**



TRH.....	ALL
Universal kit. 12.184 -0.15 ..... \$102.75 EA ⚠	

**Trunk Lid Latch**



**WASD03 ..... ALL**

This little beauty is called a Rotary Claw Latch. It's spring loaded, "slams" shut just like a bear claw latch and can be

used in a variety of applications like trunks and hoods. It is 1.8" high from the mounting surface to the top, 1.25" from the mounting surface to the striker center and the attachment holes are 3.25" center-to-center. The finish is zinc yellow chromate. Latch has cable release mechanism below the mounting surface. Striker included. -0.15

..... \$39.00 EA ⚠



**WASD04 ..... ALL**

We've seen this neat little latch showing up on some of the most eye-catching rods. Cable release ready

receiver measures 2-3/8" x 3-5/16" wide. The spring loaded stud is 2-3/4" long, overall, and the adjustable spring loading helps to pop the trunk lid up. The latch has a built-in safety feature requiring cable tension for the latch to close. The finish is zinc yellow chromate. You'll have to fabricate brackets/supports for attaching both pieces but we know you can do it!. -0.15

..... \$50.00 EA ⚠

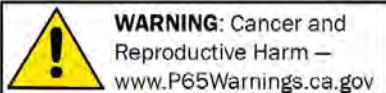

NOTE: Any chemicals will be shipped domestic ground only (Lower 48 states only). No international shipping.

**Power Trunk Lock Kit**



**13187**.....ALL  
Designed to convert your vehicles manual trunk release to power. A great addition when installing power door locks or a keyless entry system. 12.246 -0.2  
..... **\$55.00 SET** ⚠

**Hood & Trunk Latch Release Handles**



**ARM2** .....ALL  
Chrome latch release. DUAL ARM with cables and housing. -0.15  
..... **\$100.19 KIT** ⚠



**SMP22021P**.....ALL  
Polished billet aluminum dual hood and trunk release handle with cable. -0  
..... **\$160.00 EA** ⚠

**SMP22021S** .....ALL  
Satin finish aluminum dual hood and trunk release handle with cable. -0  
..... **\$138.00 EA** ⚠

**Trunk Latch Release Handles**



**ARM1** .....ALL  
Chrome latch release. SINGLE ARM with cables and housing. -0.15  
..... **\$50.00 KIT** ⚠



**SMP22022S**.....ALL  
-0 ..... **\$87.00 KIT** ⚠

**Hood/ Trunk Props**

Universal mount tunk or hood props. Polished or Black Anodized finish in 6 or 3 position adjustments. Includes brackets, fasteners & instructions. Each has 12"-20" length.

**LPP-0401014** .....ALL  
Adjustable 3 different levels, universal mount. Polished. Includes brackets, fasteners & instructions. 12"-20" length. -0.15 ..... **\$87.25 EA** ⚠

**LPP-0401024** .....ALL  
Adjustable 6 different levels universal mount. Polished. Includes brackets, fasteners & instructions. 12"-20" length. -0.15 ..... **\$90.25 EA** ⚠

**SMP22040P** .....ALL  
Universal hood and trunk prop, polished finish -0.15 ..... **\$290.00 EA** ⚠



**SMP22040S**.....ALL  
Universal hood and trunk prop, satin finish -0 ..... **\$260.00 EA** ⚠



**XLPP-0401014** .....ALL  
Black anodized. Adjustable 3 different levels, universal mount. Polished. Includes brackets, fasteners & instructions. 12"-20" length. -0.15 ..... **\$87.25 EA** ⚠

**XLPP-0401024** .....ALL  
Black anodized. Adjustable 6 different levels universal mount. Polished. Includes brackets, fasteners & instructions. 12"-20" length. -0.15 ..... **\$87.25 EA** ⚠

**Power Trunk Kit**



**13003** .....ALL  
This kit was specifically designed for anyone looking to shave the trunk, but doesn't want to deal with the hassle of reconfiguring the latch assembly. The Power Trunk Kit is easy to install, and requires no welding or special fabrication skills. The system can be mounted in various places inside of the trunk, and when closed has a holding force of over 200lbs. The system comes complete with everything you need to motorize your trunk, including an emergency entry kit that will allow you easy access in case of a power failure. -0  
..... **\$325.00 SET** ⚠

**Linear Actuators**



**12999-6** .....ALL  
6in. stroke travel, 200lb of lifting force at the push of a button. The unit has a closed length of 14-3/4 inches and an extended length of 18-3/4 inches. Utilizes clevis style attaching points at each end for quick and easy installation. 10.500 -0.15  
..... **\$212.75 EA** ⚠



**13000-8** .....ALL  
8in. stroke travel, 200lb of lifting force at the push of a button. The unit has a closed length of 16-3/4 inches and an extended length of 24-3/4 inches. Utilizes clevis style attaching points at each end for quick and easy installation. 10.500 -0.15  
..... **\$212.75 EA** ⚠

**13001-10** .....ALL  
10in. stroke travel, 200lb of lifting force at the push of a button. The unit has a closed length of 18-3/4 inches and an extended length of 28-3/4 inches. Utilizes clevis style attaching points at each end for quick and easy installation. 10.500 -0.15  
..... **\$212.75 EA** ⚠

**13002-12** .....ALL  
12in. stroke travel, 200lb of lifting force at the push of a button. The unit has a closed length of 20-3/4 inches and an extended length of 32-3/4 inches. Utilizes clevis style attaching points at each end for quick and easy installation. 8.013 -0.15  
..... **\$225.00 EA** ⚠



**Power Trunk Kit**

 13219 .....ALL  
 Universal clevis mounting bracket for actuators. 10.500 -0.15  
 ..... \$28.75 EA ⚠

**Trunk Script Emblems**

  
 R6272.....ALL  
 "Supercharged" Emblem -0.15  
 ..... \$10.39 EA ⚠

  
 R6273.....ALL  
 "Streetrod" Emblem -0.2  
 ..... \$11.00 EA ⚠

  
 R6274.....ALL  
 "Hotrod" Emblem -0.2 ... \$9.75 EA ⚠

  
 R6276.....ALL  
 "Blown" Emblem -0.15 .. \$10.19 EA ⚠

  
 R6277.....ALL  
 "Cruisin" Emblem -0.2 . \$11.25 EA ⚠

  
 R6278.....ALL  
 "Turbocharged" Emblem -0.15  
 ..... \$10.00 EA ⚠

**Books**

 **BOOK16.....ALL**  
 Automobiles of America (the first 100 years 1896-1996). 19.500 -0.4  
 ..... \$21.00 EA ⚠

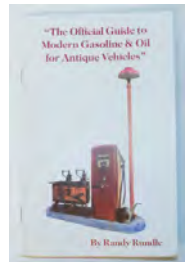
 **GASBOOK01 . . .ALL**  
 Title of this book "The Official Guide to Modern Gasoline & Oil for Antique Vehicles" says it all. 19.500 -0.15  
 ..... \$15.00 EA ⚠

 **HOTSTARTBOOKALL**  
 -0.15  
 ..... \$16.09 EA ⚠

**Basic Auto Electricity Book**

 **WASBAEB . . . .ALL**  
 Contains sections on: What is Electricity? Covers the battery, alternator, voltage regulator, grounding and fuses, designing a simple circuit & more including. Circuit Diagram, Ammeter and Volt Meter usage. A full 48 pages plus Fold out Circuit Diagram and 8-1/2" x 14" Pullout Wiring Diagram to remove and customize to match your own car's circuits.  
 0.000 -0.15  
 ..... \$11.00 EA ⚠

 **Hemmings Collector Car Encyclopedia**  
**HEMMINGPEDIA . . . ALL**  
 Hemmings Collector Car Encyclopedia -0.15  
 ..... \$14.00 EA ⚠

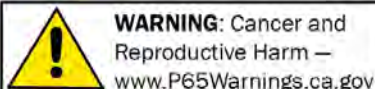

NOTE: Any chemicals will be shipped domestic ground only (Lower 48 states only). No international shipping.









**SRHQ** STREET ROD HEADQUARTERS

**Street Rod Headquarters**  
1015 NE 78th St.  
Vancouver, WA 98665  
800-952-1752

PRSR STD  
US POSTAGE PAID  
CHEVS OF THE 40'S

**WWW.STREETRODHQ.COM**

Visit us  
online!



**West Coast Hours**

**Showroom: M–F 8 a.m. – 5 p.m.**

**Phone Orders: M–F 6 a.m. – 5 p.m.**



**Cars by Ron Wade at WAAAM West**

**(Western Aeroplane and Antique Automobile Museum)**

**1015 NE 78th St. • Vancouver, WA 98662 • Thursday – Saturday 10 AM – 4 PM**